



MAY WES

Original Poly People

A DIVISION OF PRIDE SOLUTIONS



2024 / 2025 PRODUCT CATALOG

Order Online 24/7 ■ www.maywes.com

Visit the Website for New Products & Current Pricing

1 (800) 788-6483



**G4 STALK
STOMPERS**



**EXPANDED
LINEUP**

**POLY
SKID SHOES**



**AUGER TROUGH
& FLOOR LINERS**

May Wes Helps You Lower Your Operating Costs

“Thank You for Your Business. We Will Continue to Earn It.”

We know you are going through hard times this year and we are here to help.

During times like these, it's important to keep equipment running longer and squeeze the most out of every dollar. Every product in this catalog will help you lower your operating costs by extending the life of your equipment and increasing its efficiency.

Keep older corn heads running years longer with GVL Poly Snouts. Breathe new life into grain platforms with fresh UHMW skid shoes and auger trough liners. Protect expensive tires and tracks with G4 Stalk Stompers. Clean and reuse air filters with an Air Filter Blaster. Salvage a short crop with 5 Finger Quick Tines. Test crops with a Mini Combine™ to save fuel.

These are just a few examples of how May Wes can help improve your bottom line.

We've added several new products to help you get more out of your equipment. Use your corn planter to plant cover crops and small grains with SeedRight™ Seed Plates. Stop feeding the deer and invest in Kernel Keeper™ to put more corn in the combine. Throw an inexpensive Skid Hitch on your skidloader to move trailers and carts around the farmyard with ease.

In addition, we've expanded our popular skid shoe lineup with skid shoes for Honey Bee and AGCO 9255 platforms, and we offer competitively priced cutterbar skid shoes for Case IH, New Holland and MacDon.

May Wes has hundreds of products to help you stretch your budget and get through this downturn. You will find them in this catalog and even more at maywes.com. If you have any questions, your May Wes sales team is here to help. You'll also find dozens of helpful FAQ and installation videos at youtube.com/maywesmn.

All of us at May Wes wish you a safe and profitable harvest. Thank you for your business. We will continue to earn it.



Jack Daggett
President, May Wes Manufacturing
Pride Solutions, LLC

HOW CAN WE HELP YOU TODAY?



Business Hours:

February - June Monday - Thursday 8:00 am - 5:00 pm
Fridays 8:00 am - 4:00 pm
July - January Monday - Friday 8:00 am - 5:00 pm



Visit our website - www.maywes.com

Read up on products, watch videos, and place your order online right from your home, office or out in the field.



Watch Product FAQ & Installation Videos

youtube.com/maywesmn



Follow us on social media - for product news, installation videos and more.



Email our Customer Service

sales@maywes.com



Call our Customer Service

1-800-788-6483

MAY WES POLICIES & PROCEDURES

Scope: These policies apply to all business units operating under the Pride Solutions LLC company. Namely: May Wes Manufacturing, C&A Pro Skis, Pride Engineered Plastics and Pride Assembly.

Prices & Terms: Prices and availability are subject to change without notice. All shipments are billed at the price prevailing at the time of shipment. Payment terms are agreed upon prior to or at time of sales and will be listed on the invoice. In the event of non-payment, the buyer shall pay any and all collection costs, including attorney fees.

Payment types currently accepted include Visa, Mastercard, Discover, American Express, Cash or Check.

Shipment: All orders will be shipped in the order they are received. Orders can be shipped UPS ground, UPS second day air, UPS next day air or any other available means (including Spee-Dee where suitable). Truck freight will be used when price competitive to UPS or when weight/size dictate otherwise. Pride Solutions is not responsible for goods damaged or lost in transit. We will work with the carrier to resolve the problem.

Warranty: Pride Solutions warrants the product to be free of material and workmanship defects which are apparent upon receipt and initial use of the product. Wear items such as liners, skid shoes and bearings are guaranteed for a reasonable run time, not to exceed one year from the date of purchase. Warranty claims must be reported within 15 days of occurrence of defect. Warranty does not cover damage from improper installation or unintended use of the product. Pride Solutions does not accept responsibility for any damages incurred on the equipment to which the product is applied. The warranty value is limited to the purchase price of the merchandise. No incidental, consequential, indirect losses or

TABLE OF CONTENTS

G4 Stalk Stompers

G4 Introduction	1-2
Case IH 4400 / 4200 / 2600	3-4
Case IH 3400 / 3200 / 2400 / 2200	5-6
Case IH 1000 / 900	7-8
New Holland 99C / 980	9-10
New Holland 96C / 98C / 98D / 996	11-12
John Deere C-Series	13-14
John Deere 600 / 700 Series	15-16
John Deere 90 / 40 Series	17-18
Drago GT	19-20
Drago Series I & II	21
Harvestec 5000 & 6000 Series	22
MacDon C-Series	23-24
Geringhoff Horizon	25
Geringhoff Patriot / Northstar / Rota Disc	26
Lexion	27
AGCO: Massey / Gleaner / Challenger	28
Capello Diamant	29-30
Capello Quasar	31
Fantini	32
QD2 Replacement Parts	33

Tractor Parts

G4 Tractor Stalk Stompers - Intro	34
G4 Tractor Stalk Stomper Kits	35-36
Tractor Stalk Stomper Components	37-38
Draw Bar Savers	39
Rear Fender Extensions for John Deere	39

Hay & Forage

Poly Pickup Bands	40-44
Hay Knife	44
Rubber Molded Rake & Baler Teeth	45-46
BaleSkis® Baler Liners	47-48

Skid Shoes

Skid Shoes - Intro	49
Skid Shoes for Case IH	50-59
Skid Shoes for New Holland	60-69
Skid Shoes for John Deere	70-75
Skid Shoes for MacDon	76-79
Claas / Lexion / Caterpillar	80

Skid Shoes (continued...)

Skid Shoes for Gleaner / Massey	81-91
Skid Shoes for AGCO	87-88
Skid Shoes for Honey Bee	89
Swather & Haybine Poly Skid Shoes	92
Disc Mower & Discbine Poly Skid Shoes	92

Combine Parts

Grain Tank Auger Trough Liners	93
Auger Bed Liners	93
Universal Auger Tube Liner	94
Tank Fill/Bubble Up Tube Liners	94
Chaff Spreaders for Case IH 1400-2500 Series	95
Clean Out Doors	96
Seed Flow Sensor Impact Wear Plate	96
Feederhouse Silencer Kits for Case IH	97-98
Sieve Easy Adjust Kit for Case IH	98
Poly Chain Guides for John Deere	98
Clean Grain Elevator Poly Paddles	99-100
Mini Combine™	100

Corn Head Parts

Poly Corn Snouts	101-105
Poly Corn Snout Replacement Parts	105
Crop Divider Front Wear Kits	106
Crop Divider Rear Wear Kits	106
Poly Snout Patch	106
Poly Snout Savers	107
Snoot Boots	107
Auger Trough Liners for Corn Heads	108
Kernel Keeper™	109-110
Shoe Covers for John Deere C-Series OEM Stalk Stompers	110
Crop Shields / Trash Aprons for John Deere	111-114
Crop Shields / Trash Aprons Replacement Parts for Case IH	115
Row Divider Shields	115
Ear Savers	116

Grain Head Parts

Auger Trough Liners for Grain Heads	117
Retractable Poly Fingers	118-122
5-Finger Quick Tines, Snap-On Tines & Quick Fingers	123
Poly Reel Tines	124

Grain Head Parts (continued...)

Paddle Tines	124
Crop Dividers	125
Tru-Tube® Auger Straightener	125
Poly Tin Replacement Shield for Case IH	125

Auger Wearshoes

Auger Wearshoes - Intro	126
Custom Auger Wearshoes	127
Auger Wearshoes for Case IH	128
Auger Wearshoes for New Holland	128
Auger Wearshoes for John Deere	129-130
Auger Wearshoes for Gleaner	130
Auger Wearshoes for Massey Ferguson	131
Auger Wearshoes for Grain Carts	131-132

Planting & Tillage

G4 Planter Stalk Stompers	133
Shank Savers	133
Pro Chute	134
Shank Protectors	134
Rapid Drain Filter Tile Inlet	134
Rapid Drain Filter Riser	134
SeedRight™ Seed Plates	135
Gauge & Press Wheel Scrapers	135
Rebounder™ Seed Covers & Y-Not Split-It™	136
Closing Wheels	137-138
Planter Box Toppers & Hinges	138
Fertilizer Box Toppers	138
Seed Fill Tubes - Telescoping	139
Seed Fill Tubes - Non-Telescoping	139
Poly Cupped & Straight Auger Flighting	140-142

Other Products

Poly Cutting Edges	143-144
Skid Hitch	145
LockNLube® & LockNFlate®	145
Air Filter Blaster	146
Ride Tamer Zero-Turn Suspension System	146
SlickPlate™ by Minimizer™	147
Bulk Poly	148
Poly Chain Tighteners	148
Poly Capped Bolts	149
Hardware	149

ATTENTION MINNESOTA CUSTOMERS & DEALERS:

If you feel you qualify for Tax Exempt Status, please call us for the tax exempt form. Complete the information and send or fax it to May Wes Manufacturing. Tax Exempt status will only be granted upon receipt of completed form with signature.

MAIL: May Wes Manufacturing
120 Eastgate Drive S.E.
Hutchinson, MN 55350

EMAIL: sales@maywes.com
FAX: 320-587-6112

damages, expressed or implied, are covered. A warranty claim must be processed with either return of the defective product or reasonable proof that the product failed. Items returned for warranty must be accompanied by a Return Material Authorization (RMA) obtained from Pride Solutions customer service at 1-800-788-6483. If the end user purchased from a dealer or authorized distributor, the dealer or authorized distributor must make the warranty claim. Defective product will be replaced with same or better product. Account credit will be given when a reasonable replacement cannot be provided.

Returns: Merchandise returned for credit must be returned within 90 days of receipt. If the end user purchased from a dealer or authorized distributor, the dealer or authorized distributor must initiate the return. All returns must be accompanied by a Return Material Authorization (RMA) number issued by a Pride Solutions customer service representative at 1-800-788-6483. Pride Solutions is not responsible for freight charges and may assess up to a 25% restocking fee for all properly filled orders. In the event of wrong and/or missing parts on an order, the restocking fee is waived and Pride Solutions will pay freight. Merchandise must be returned complete and unused, including hardware. The customer account will be credited the purchase price of the merchandise less the restocking fee (if applicable).

Non-Affiliation With Companies Mentioned: maywes.com is owned and operated by Pride Solutions LLC. Some of our products are compatible with brands listed as an aftermarket vendor. Pride Solutions LLC is not endorsed, sponsored by or affiliated with any other companies mentioned. All brands, copyrights, logos, likenesses, specific model numbers, and registered trademarks are property of their respective companies or organizations.

NEW PRODUCTS

G2 Star Wheel
Improved Design - Catches Less Debris
83888 - \$136/pr

page 137

Hay Knife
Simple Bale Wrap Removal Tool
83947 - \$31/ea

page 44

Honey Bee Skid Shoe
For Airflex, Airflex SDX, & RDX
83920 - \$212/10 pk
23085 - \$22/ea

page 89

Cutterbar Skid Shoe
For Case IH, New Holland & MacDon
83840 - \$109/10 pk
22723 - \$12/ea

starting on page 49

Snow Pusher Skid Shoes
1 1/2" Thick for Ultimate Durability
83946 - \$6.30/running inch
page 143

LockNLube® & LockNFlate®
Eliminates Mess, Simple to Use
Locks On & Stays On
page 145

Row Divider Shields
For John Deere C-Series 20/22"
42759 - \$75/ea
page 115

Skid Hitch
For All Skid Loader Makes & Models
83884 - \$195/ea
page 145

Ride Tamer
Improve Your Bumpy Zero-Turn Ride
Available for John Deere, Toro and Scag Zero-Turn Models
page 146

Mini Combine™
Quick & Accurate Crop Samples
83882 - \$1565/kit
page 100

SeedRight™ Seed Plates
Plant Cover Crops With Your Planter
Available for John Deere, Kinze & Precision Planting Meters
page 135

Kernel Keeper™
Put More Bushels in Your Combine
Expanded Lineup of Kits & Replacement Parts
pages 109-110

CONNECT WITH MAY WES

THANK YOU TO OUR SOCIAL INFLUENCER PARTNERS
Visit these YouTube channels to see our products in action!



Minnesota Millennial Farmer



Larson Farms



Fast Ag Montana



Stanley "Dirt Monkey" Genadek



Welker Farms



Brian's Farming Videos



Finstad Skidloader & Snow Removal Service

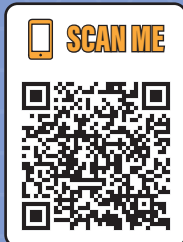

Look for QR codes throughout the catalog to watch product installation & FAQ videos on YouTube.

Follow May Wes Manufacturing on social media for product updates, installation tips and more. Tag us in your photos for a chance to be featured!

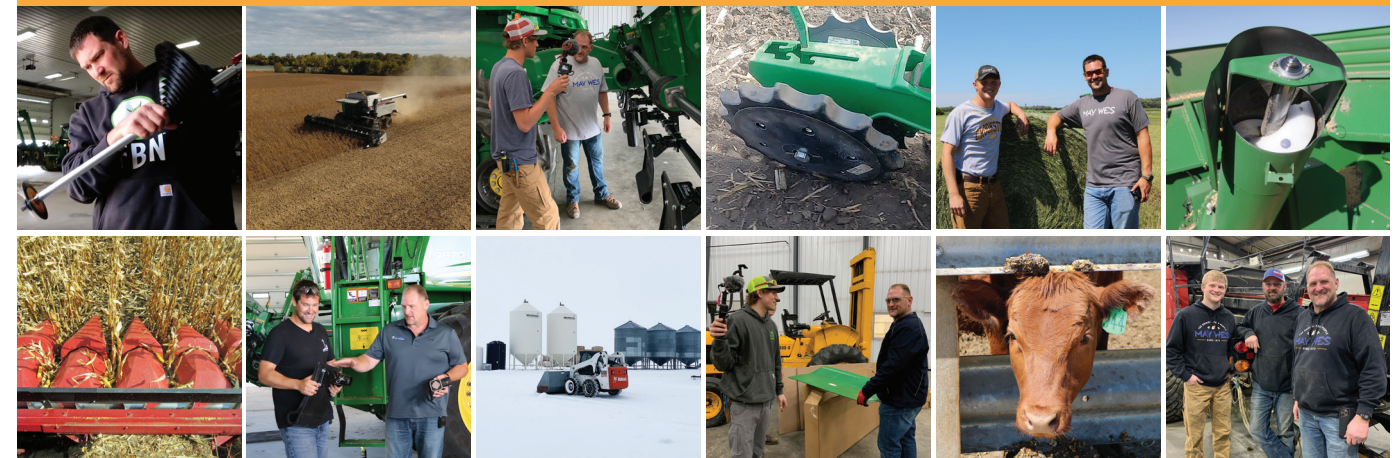

Find us online at 

G4 STALK STOMPERS

PROTECT YOUR TIRES & TRACKS

G4 Stalk Stompers

Patent #US11039572B1



Combine tires and tracks are expensive! Protect yours from stubble damage with May Wes G4 Stalk Stompers.

\$1,700+

Average Cost of a Single Combine Tire Before Mounting & Disposal

\$10,000+

Average Cost of a Single 30" Combine Track

\$481

Average Cost Per Row of G4 Stalk Stomper Coverage



12" Molded UHMW Durable Poly Shoe



Torsion Spring Provides 30° of Flex in Either Direction

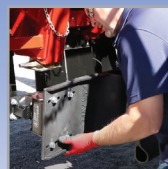

Easy to Install & Reposition

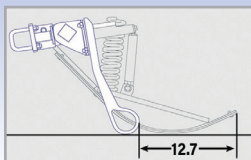

30% Lighter than Previous Design



Compatible with Most Header Trailers



Compatible with Folding Heads

G4 STALK STOMPERS

AVAILABLE FOR ALL MAJOR HEADERS



As Featured by Larson Farms & Millennial Farmer



Larson Farms - John Deere 712FC



Larson Farms - Geringhoff Horizon 12RF

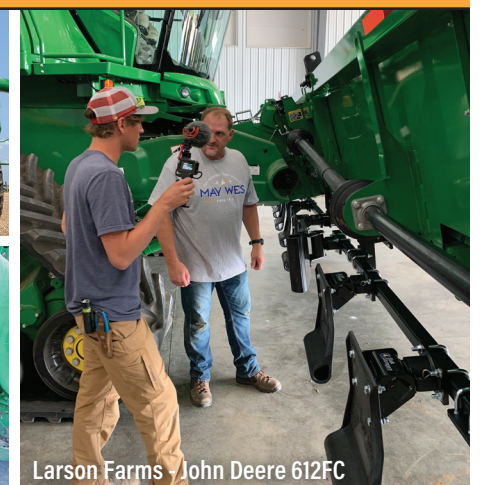

Larson Farms - John Deere 612C

The Big Swede Reviews G4 Stalk Stompers

Watch now!



Millennial Farmer - John Deere 612C

Field Tested. Farmer Approved.

"Tires and tracks for combines have gotten really expensive. That's why we protect ours with May Wes G4 Stalk Stompers. They do a really good job of leveling out the stalks, even when conditions are frozen or wet."

-Zach Johnson, MN Millennial Farmer

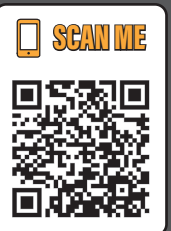

Proudly Made in the U.S.A.



Made in Minnesota Manufacturing Award



Installation Videos on YouTube

Non-Affiliation With Companies Mentioned: maywes.com is owned and operated by Pride Solutions LLC. Some of our products are compatible with brands listed as an aftermarket vendor. Pride Solutions LLC is not endorsed, sponsored by or affiliated with any other companies mentioned. All brands, copyrights, logos, likenesses, specific model numbers, and registered trademarks are property of their respective companies or organizations.



G4 STALK STOMPERS

KITS FOR CASE IH 4400 / 4200 / 2600 SERIES: 2-18 ROW HEADS

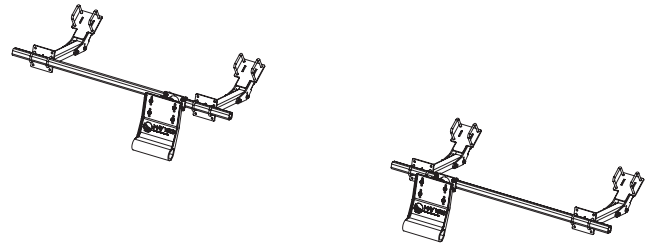

PART NO	DESCRIPTION	RETAIL PRICE
84891	2 Row Kit	\$ 2009
84898	Kit without Toolbar	\$ 1854
Included Parts		Quantity
2x2 Toolbar - 72"		Qty: 2
Head Mounting Brackets		Qty: 4
Toolbar Splice		N/A

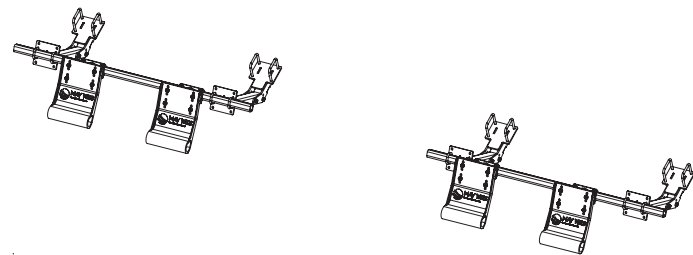

PART NO	DESCRIPTION	RETAIL PRICE
84892	4 Row Kit	\$ 2653
84899	Kit without Toolbar	\$ 2498
Included Parts		Quantity
2x2 Toolbar - 72"		Qty: 2
Head Mounting Brackets		Qty: 4
Toolbar Splice		N/A

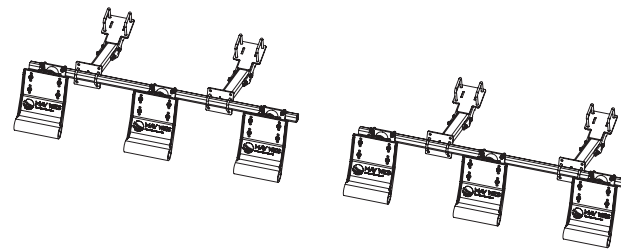

PART NO	DESCRIPTION	RETAIL PRICE
84893	6 Row Kit	\$ 3296
84900	Kit without Toolbar	\$ 3090
Included Parts		Quantity
2x2 Toolbar - 102"		Qty: 2
Head Mounting Brackets		Qty: 4
Toolbar Splice		N/A

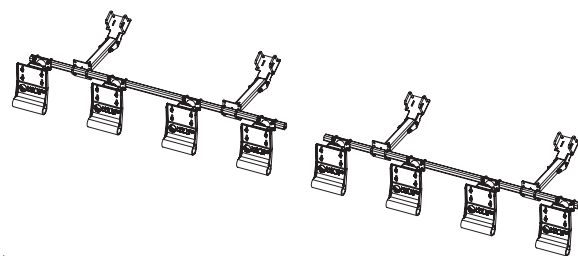

PART NO	DESCRIPTION	RETAIL PRICE
84894	8 Row Kit	\$ 3914
84901	Kit without Toolbar	\$ 3554
Included Parts		Quantity
2x2 Toolbar - 102"		Qty: 2
Head Mounting Brackets		Qty: 4
Toolbar Splice		N/A

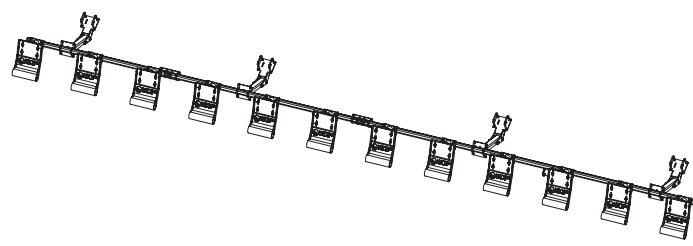

PART NO	DESCRIPTION	RETAIL PRICE
84895	12 Row Kit	\$ 5202
84902	Kit without Toolbar	\$ 4790
Included Parts		Quantity
2x2 Toolbar - 72"		Qty: 2
- 102"		Qty: 2
Head Mounting Brackets		Qty: 4
Toolbar Splice		Qty: 4



G4 STALK STOMPERS

KITS FOR CASE IH 4400 / 4200 / 2600 SERIES: 2-18 ROW HEADS

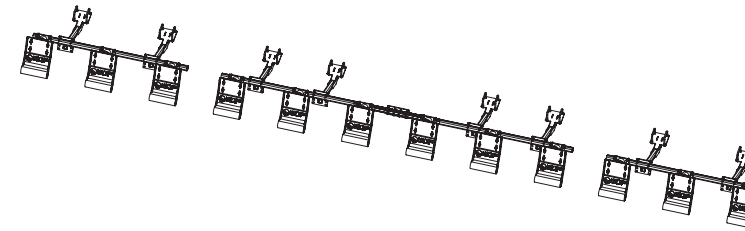

PART NO	DESCRIPTION	RETAIL PRICE
84943	12 Row Kit for Folding Head	\$ 6155
84944	Kit without Toolbar	\$ 5717
Included Parts		Quantity
2x2 Toolbar - 72"		Qty: 2
- 102"		Qty: 2
Head Mounting Brackets		Qty: 8
Toolbar Splice		Qty: 2

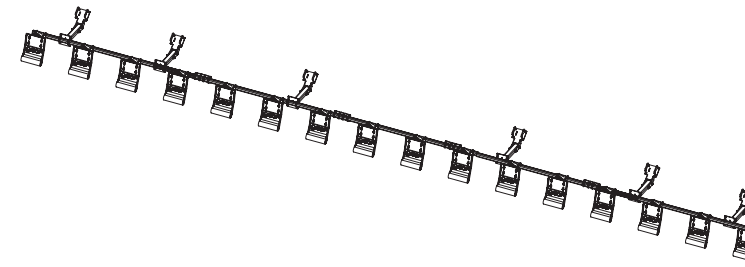

PART NO	DESCRIPTION	RETAIL PRICE
84896	16 Row Kit	\$ 6979
84903	Kit without Toolbar	\$ 6464
Included Parts		Quantity
2x2 Toolbar - 102"		Qty: 5
Head Mounting Brackets		Qty: 6
Toolbar Splice		Qty: 4

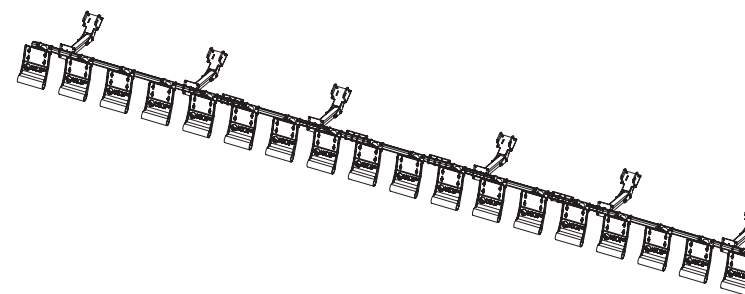

PART NO	DESCRIPTION	RETAIL PRICE
84897	18 Row Kit	\$ 7700
84904	Kit without Toolbar	\$ 7185
Included Parts		Quantity
2x2 Toolbar - 72"		Qty: 2
- 102"		Qty: 3
Head Mounting Brackets		Qty: 6
Toolbar Splice		Qty: 4

The 2x2 toolbar is required but can be purchased locally to reduce shipping cost. This is standard 2x2 square 3/16" - sidewall tubing available from most fabrication shops or metal supply companies.

REPLACEMENT PARTS FOR CASE IH 4400 / 4200 / 2600 SERIES

<p>Single Row Shoe Assembly 43102 \$ 428 ea</p>	<p>12" Shoe 24100 \$ 148 ea</p>	<p>2x2 Toolbar 72" 41672 \$ 124 ea 102" 41673 \$ 181 ea</p>
<p>Adjustable Header Arm Mount Bracket 42472 \$ 315 ea</p>	<p>Torsion Unit 42295 \$ 206 ea</p>	
<p>Toolbar Mount Bracket 43101 \$ 125 ea</p>	<p>Toolbar Splice 41827 \$ 63 ea</p>	<p>Bent Pin & Clip (2 pack) 42384 \$ 12 pk</p>

INSTALLATION VIDEO
Case IH 4400 Series

SCAN ME

Scan the QR code with your smartphone to watch on YouTube.



G4 STALK STOMPERS

KITS FOR CASE IH 3400 / 3200 / 2400 / 2200 SERIES: 6 ROW HEADS

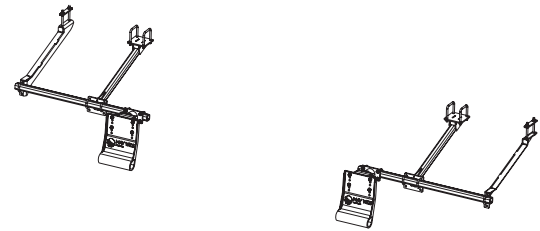

PART NO	DESCRIPTION	RETAIL PRICE
84908	2 Row Kit	\$ 1751
84924	Kit without Toolbar	\$ 1494
Included Parts		Quantity
2x2 Toolbar - 72"		Qty: 2
Head Mounting Brackets		Qty: 4
Toolbar Splice		N/A

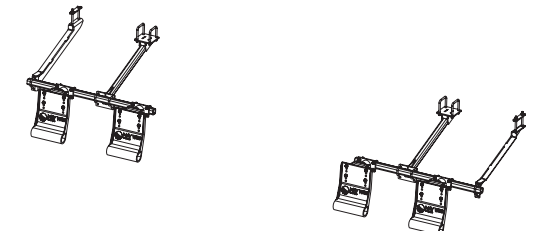

PART NO	DESCRIPTION	RETAIL PRICE
84909	4 Row Kit	\$ 2272
84925	Kit without Toolbar	\$ 2060
Included Parts		Quantity
2x2 Toolbar - 72"		Qty: 2
Head Mounting Brackets		Qty: 4
Toolbar Splice		N/A

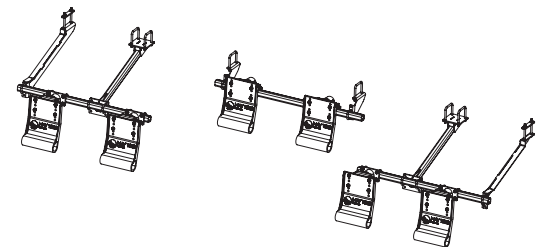

PART NO	DESCRIPTION	RETAIL PRICE
84911	6 Row Kit	\$ 3477
84927	Kit without Toolbar	\$ 3193
Included Parts		Quantity
2x2 Toolbar - 72"		Qty: 3
Head Mounting Brackets		Qty: 6
Toolbar Splice		N/A

KITS FOR CASE IH 2200 / 2400 / 3200 / 3400 SERIES: 8 & 12 ROW HEADS



PART NO	DESCRIPTION	RETAIL PRICE
84912	2 Row Kit	\$ 2009
84928	Kit without Toolbar	\$ 1829
Included Parts		Quantity
2x2 Toolbar - 72"		Qty: 2
Head Mounting Brackets		Qty: 4
Toolbar Splice		N/A

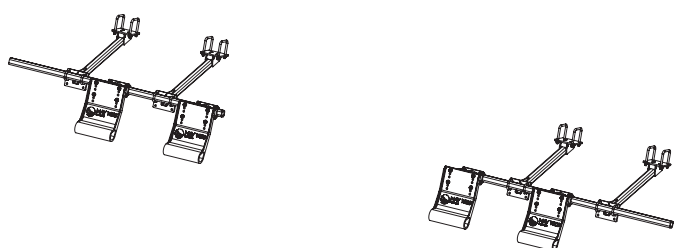

PART NO	DESCRIPTION	RETAIL PRICE
84913	4 Row Kit	\$ 2601
84929	Kit without Toolbar	\$ 2447
Included Parts		Quantity
2x2 Toolbar - 72"		Qty: 2
Head Mounting Brackets		Qty: 4
Toolbar Splice		N/A

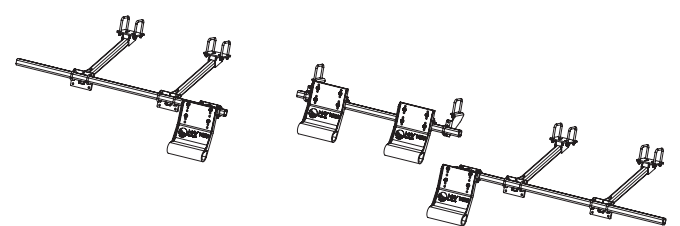

PART NO	DESCRIPTION	RETAIL PRICE
84914	4 Row Kit	\$ 2704
84930	Kit without Toolbar	\$ 2550
Included Parts		Quantity
2x2 Toolbar - 72"		Qty: 3
Head Mounting Brackets		Qty: 6
Toolbar Splice		N/A



G4 STALK STOMPERS

KITS FOR CASE IH 3400 / 3200 / 2400 / 2200 SERIES: 8 & 12 ROW HEADS

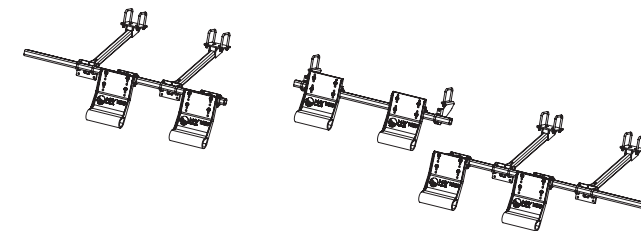

PART NO	DESCRIPTION	RETAIL PRICE
84915	6 Row Kit	\$ 3528
84931	Kit without Toolbar	\$ 3296
Included Parts		Quantity
2x2 Toolbar - 72"		Qty: 3
Head Mounting Brackets		Qty: 6
Toolbar Splice		N/A

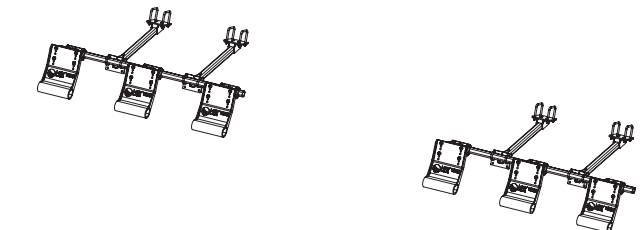

PART NO	DESCRIPTION	RETAIL PRICE
84916	6 Row Kit	\$ 3451
84932	Kit without Toolbar	\$ 3219
Included Parts		Quantity
2x2 Toolbar - 72"		Qty: 2
Head Mounting Brackets		Qty: 4
Toolbar Splice		N/A

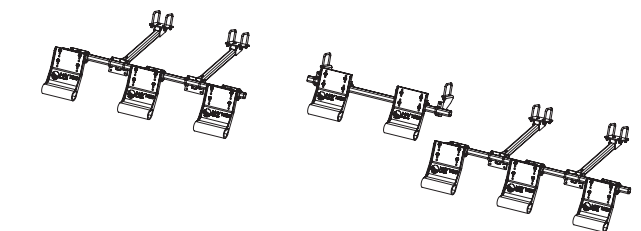

PART NO	DESCRIPTION	RETAIL PRICE
84917	8 Row Kit	\$ 4223
84933	Kit without Toolbar	\$ 3914
Included Parts		Quantity
2x2 Toolbar - 72"		Qty: 3
Head Mounting Brackets		Qty: 6
Toolbar Splice		N/A

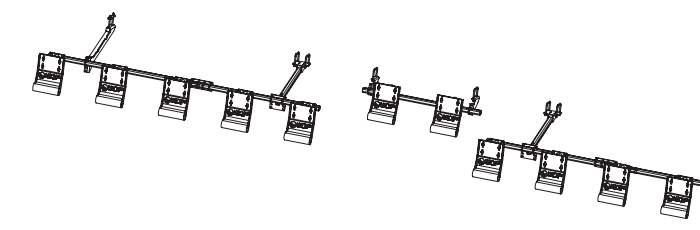

PART NO	DESCRIPTION	RETAIL PRICE
84918	12 Row Kit	\$ 5588
84934	Kit without Toolbar	\$ 5073
Included Parts		Quantity
2x2 Toolbar - 72"		Qty: 5
Head Mounting Brackets		Qty: 6
Toolbar Splice		Qty: 2

16 & 18 Row Kits Available. Contact May Wes or your dealer for ordering information.
 The 2x2 toolbar is required but can be purchased locally to reduce shipping cost.
 This is standard 2x2 square 3/16" - sidewall tubing available from most fabrication shops or metal supply companies.

REPLACEMENT PARTS FOR CASE IH 3400 / 3200 / 2400 / 2200 SERIES

<p>Single Row Shoe Assembly 43102 \$ 428 ea</p>	<p>Single Center Row Shoe Assembly 43115 \$ 428 ea</p>	<p>12" Shoe 24100 \$ 148 ea</p>	<p>Toolbar Splice 41827 \$ 63 ea</p>	<p>Torsion Unit 42295 \$ 206 ea</p>
<p>Header Bracket 42450 \$ 309 ea</p>	<p>Left End Header Bracket 42452 \$ 247 ea</p>	<p>Right End Header Bracket 42465 \$ 247 ea</p>	<p>Center Header Bracket 42454 \$ 83 ea</p>	<p>Bent Pin & Clip (2 pack) 42384 \$ 12 pk</p>
<p>Toolbar Mount Bracket 43101 \$ 125 ea</p>	<p>Center Row Toolbar Mount Bracket 43111 \$ 125 ea</p>	<p>2x2 Toolbar 72" 41672 \$ 124 ea 102" 41673 \$ 181 ea</p>	<p>ORDER ONLINE 24/7</p>	



G4 STALK STOMPERS

KITS FOR CASE IH 1000 /900 SERIES: 6 ROW HEADS

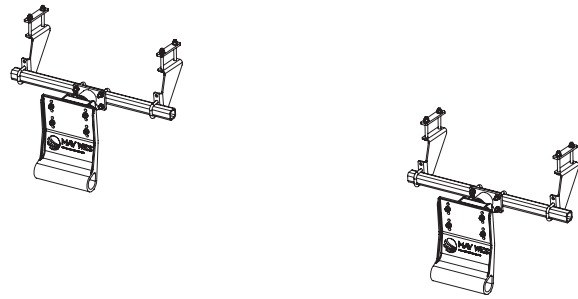

PART NO	DESCRIPTION	RETAIL PRICE
84981	2 Row Kit	\$ 1288
84857	Kit without Toolbar	\$ 1133
Included Parts		Quantity
2x2 Toolbar - 72"		Qty: 2
Head Mounting Brackets		Qty: 4
Toolbar Splice		N/A

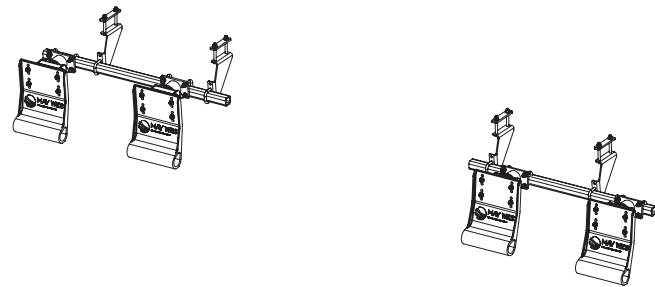

PART NO	DESCRIPTION	RETAIL PRICE
84983	4 Row Kit	\$ 1932
84859	Kit without Toolbar	\$ 1751
Included Parts		Quantity
2x2 Toolbar - 72"		Qty: 2
Head Mounting Brackets		Qty: 4
Toolbar Splice		N/A

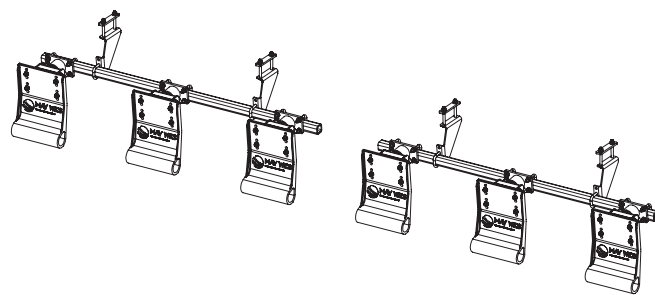

PART NO	DESCRIPTION	RETAIL PRICE
84984	6 Row Kit	\$ 2884
84860	Kit without Toolbar	\$ 2678
Included Parts		Quantity
2x2 Toolbar - 102"		Qty: 2
Head Mounting Brackets		Qty: 4
Toolbar Splice		N/A

KITS FOR CASE IH 900 /1000 SERIES: 8 ROW HEADS

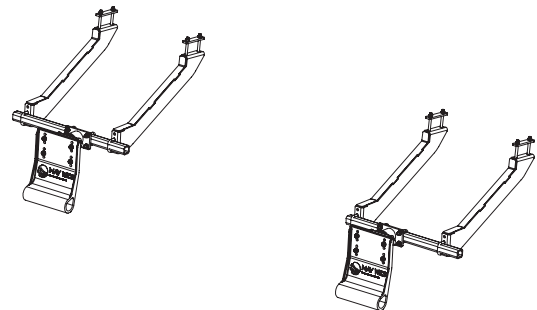

PART NO	DESCRIPTION	RETAIL PRICE
84985	2 Row Kit	\$ 1751
84861	Kit without Toolbar	\$ 1545
Included Parts		Quantity
2x2 Toolbar - 72"		Qty: 2
Head Mounting Brackets		Qty: 4
Toolbar Splice		N/A

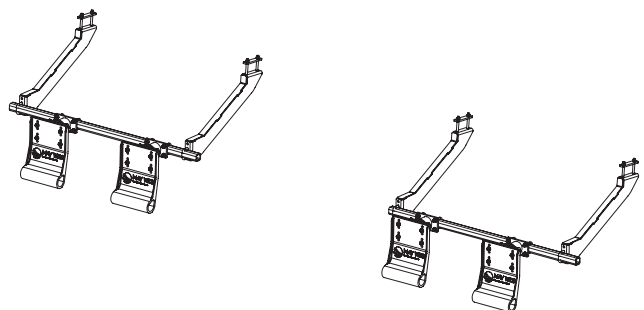

PART NO	DESCRIPTION	RETAIL PRICE
84986	4 Row Kit	\$ 2421
84862	Kit without Toolbar	\$ 2215
Included Parts		Quantity
2x2 Toolbar - 72"		Qty: 2
Head Mounting Brackets		Qty: 4
Toolbar Splice		N/A



G4 STALK STOMPERS

KITS FOR CASE IH 1000 /900 SERIES: 8 ROW HEADS

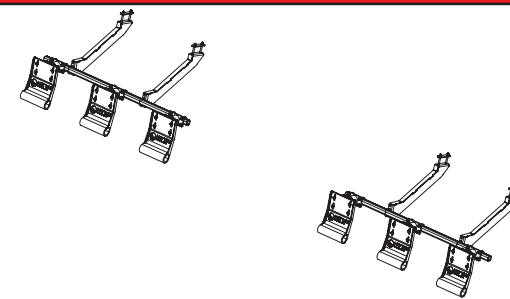

PART NO	DESCRIPTION	RETAIL PRICE
84989	6 Row Kit	\$ 3245
84865	Kit without Toolbar	\$ 3039
Included Parts		Quantity
2x2 Toolbar - 102"		Qty: 2
Head Mounting Brackets		Qty: 4
Toolbar Splice		N/A

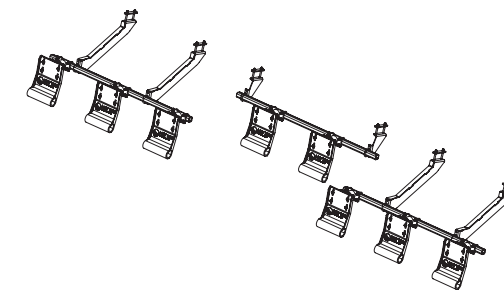

PART NO	DESCRIPTION	RETAIL PRICE
84990	8 Row Kit	\$ 3708
84866	Kit without Toolbar	\$ 3528
Included Parts		Quantity
2x2 Toolbar - 102"		Qty: 3
Head Mounting Brackets		Qty: 6
Toolbar Splice		N/A

The 2x2 toolbar is required but can be purchased locally to reduce shipping cost. This is standard 2x2 square 3/16" - sidewall tubing available from most fabrication shops or metal supply companies.

REPLACEMENT PARTS FOR CASE IH 1000 /900 SERIES

<p>Single Row Shoe Assembly 43102 \$ 428 ea</p>	<p>12" Shoe 24100 \$ 148 ea</p>	<p>2x2 Toolbar 72" 41672 \$ 124 ea 102" 41673 \$ 181 ea</p>	<p>Bent Pin & Clip (2 pack) 42384 \$ 12 pk</p>
<p>Toolbar Mount Bracket 43101 \$ 125 ea</p>	<p>Header Bracket 42485 \$ 248 ea</p>	<p>Center Header Bracket 42477 \$ 79 ea</p>	<p>Torsion Unit 42295 \$ 206 ea</p>



KERNEL KEEPER

INCREASE YIELD
REDUCE SHELLING & SWEEP LOOSE KERNELS INTO THE AUGER

KITS ON PAGES 109-110



G4 STALK STOMPERS

KITS FOR NEW HOLLAND 99C /980 SERIES: 2-18 ROW HEADS

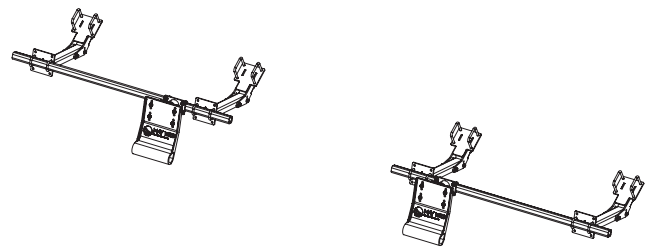

PART NO	DESCRIPTION	RETAIL PRICE
84891	2 Row Kit	\$ 2009
84898	Kit without Toolbar	\$ 1854
Included Parts		Quantity
2x2 Toolbar - 72"		Qty: 2
Head Mounting Brackets		Qty: 4
Toolbar Splice		N/A

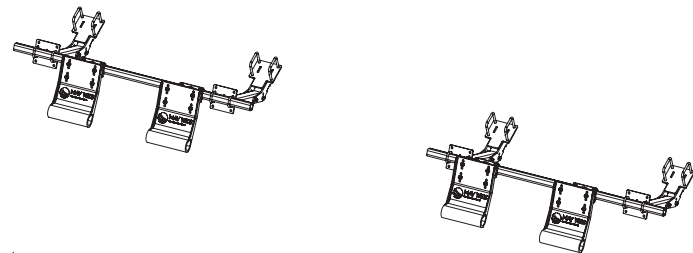

PART NO	DESCRIPTION	RETAIL PRICE
84892	4 Row Kit	\$ 2653
84899	Kit without Toolbar	\$ 2498
Included Parts		Quantity
2x2 Toolbar - 72"		Qty: 2
Head Mounting Brackets		Qty: 4
Toolbar Splice		N/A

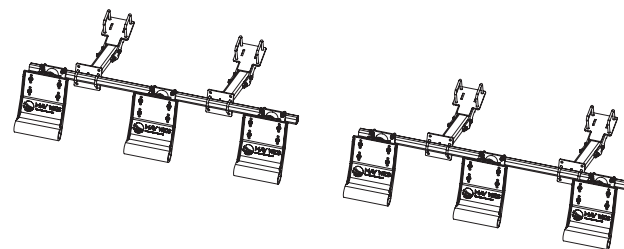

PART NO	DESCRIPTION	RETAIL PRICE
84893	6 Row Kit	\$ 3296
84900	Kit without Toolbar	\$ 3090
Included Parts		Quantity
2x2 Toolbar - 102"		Qty: 2
Head Mounting Brackets		Qty: 4
Toolbar Splice		N/A

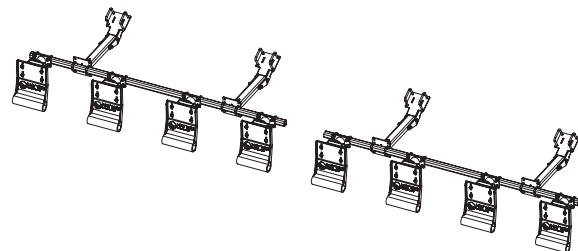

PART NO	DESCRIPTION	RETAIL PRICE
84894	8 Row Kit	\$ 3914
84901	Kit without Toolbar	\$ 3554
Included Parts		Quantity
2x2 Toolbar - 102"		Qty: 2
Head Mounting Brackets		Qty: 4
Toolbar Splice		N/A

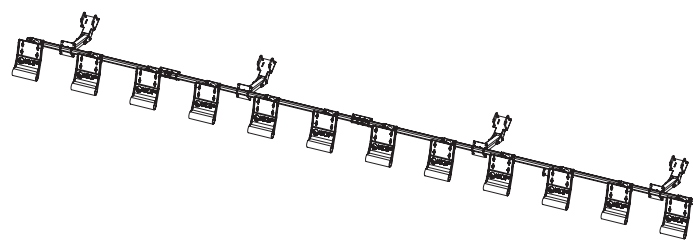

PART NO	DESCRIPTION	RETAIL PRICE
84895	12 Row Kit	\$ 5202
84902	Kit without Toolbar	\$ 4790
Included Parts		Quantity
2x2 Toolbar - 72"		Qty: 2
- 102"		Qty: 2
Head Mounting Brackets		Qty: 4
Toolbar Splice		Qty: 4



G4 STALK STOMPERS

KITS FOR NEW HOLLAND 99C /980 SERIES: 2-18 ROW HEADS

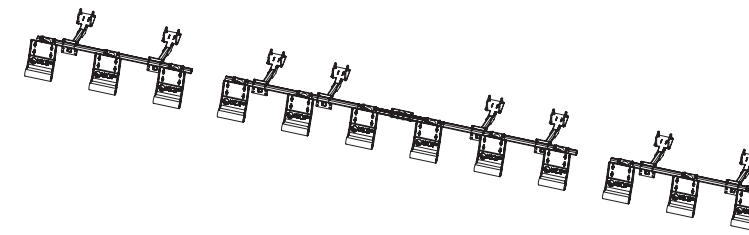

PART NO	DESCRIPTION	RETAIL PRICE
84943	12 Row Kit for Folding Head	\$ 6155
84944	Kit without Toolbar	\$ 5717
Included Parts		Quantity
2x2 Toolbar - 72"		Qty: 2
- 102"		Qty: 2
Head Mounting Brackets		Qty: 8
Toolbar Splice		Qty: 2

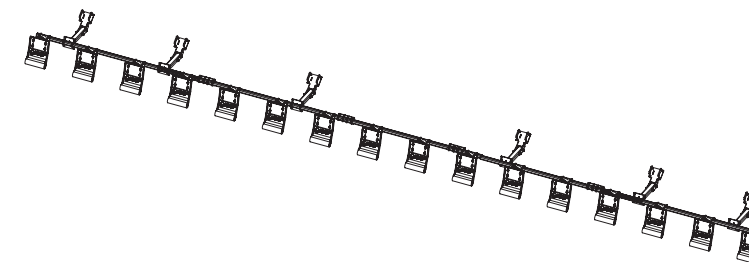

PART NO	DESCRIPTION	RETAIL PRICE
84896	16 Row Kit	\$ 6979
84903	Kit without Toolbar	\$ 6464
Included Parts		Quantity
2x2 Toolbar - 102"		Qty: 5
Head Mounting Brackets		Qty: 6
Toolbar Splice		Qty: 4

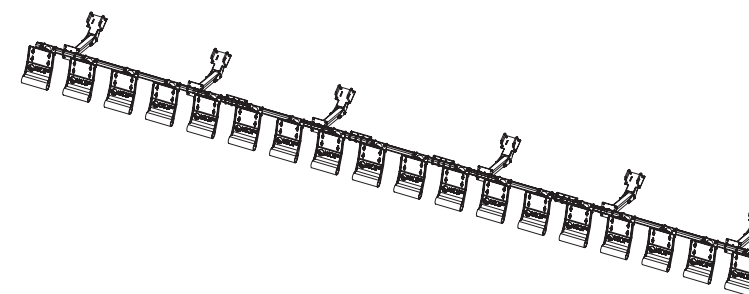

PART NO	DESCRIPTION	RETAIL PRICE
84897	18 Row Kit	\$ 7700
84904	Kit without Toolbar	\$ 7185
Included Parts		Quantity
2x2 Toolbar - 72"		Qty: 2
- 102"		Qty: 3
Head Mounting Brackets		Qty: 6
Toolbar Splice		Qty: 4

The 2x2 toolbar is required but can be purchased locally to reduce shipping cost. This is standard 2x2 square 3/16" - sidewall tubing available from most fabrication shops or metal supply companies.

REPLACEMENT PARTS FOR NEW HOLLAND 99C /980 SERIES

<p>Single Row Shoe Assembly 43102 \$ 428 ea</p>	<p>12" Shoe 24100 \$ 148 ea</p>	<p>2x2 Toolbar 72" 41672 \$ 124 ea 102" 41673 \$ 181 ea</p>	<p>Bent Pin & Clip (2 pack) 42384 \$ 12 pk</p>
<p>Adjustable Header Arm Mount Bracket 42472 \$ 315 ea</p>	<p>Torsion Unit 42295 \$ 206 ea</p>	<p>Toolbar Mount Bracket 43101 \$ 125 ea</p>	<p>Toolbar Splice 41827 \$ 63 ea</p>



G4 STALK STOMPERS

KITS FOR NEW HOLLAND 96C /98C /98D /996 SERIES: 6 ROW HEADS

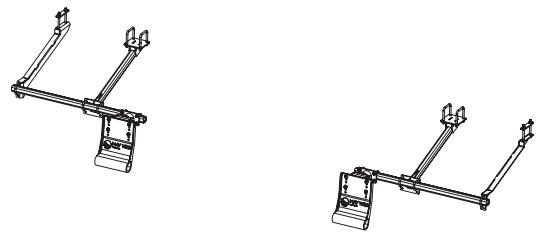

PART NO	DESCRIPTION	RETAIL PRICE
84908	2 Row Kit	\$ 1751
84924	Kit without Toolbar	\$ 1494
Included Parts		Quantity
2x2 Toolbar - 72"		Qty: 2
Head Mounting Brackets		Qty: 4
Toolbar Splice		N/A

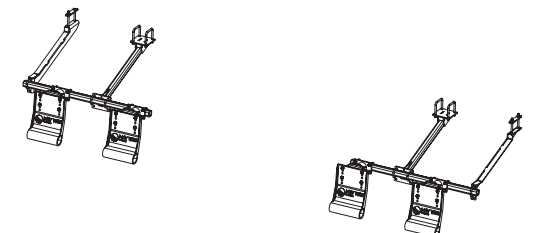

PART NO	DESCRIPTION	RETAIL PRICE
84909	4 Row Kit	\$ 2272
84925	Kit without Toolbar	\$ 2060
Included Parts		Quantity
2x2 Toolbar - 72"		Qty: 2
Head Mounting Brackets		Qty: 4
Toolbar Splice		N/A

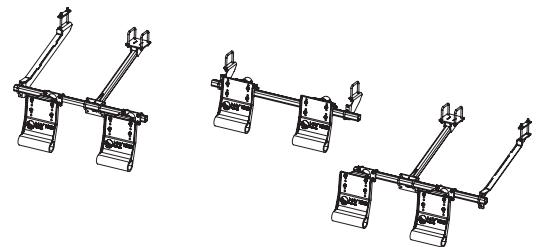

PART NO	DESCRIPTION	RETAIL PRICE
84911	6 Row Kit	\$ 3477
84927	Kit without Toolbar	\$ 3193
Included Parts		Quantity
2x2 Toolbar - 72"		Qty: 3
Head Mounting Brackets		Qty: 6
Toolbar Splice		N/A

KITS FOR NEW HOLLAND 96C /98C /98D /996 SERIES: 8 & 12 ROW HEADS

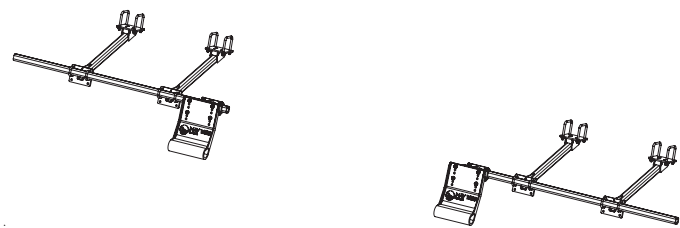

PART NO	DESCRIPTION	RETAIL PRICE
84912	2 Row Kit	\$ 2009
84928	Kit without Toolbar	\$ 1829
Included Parts		Quantity
2x2 Toolbar - 72"		Qty: 2
Head Mounting Brackets		Qty: 4
Toolbar Splice		N/A

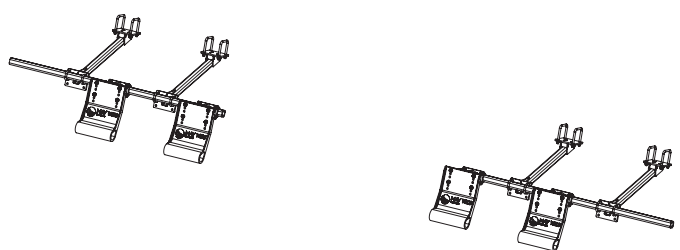

PART NO	DESCRIPTION	RETAIL PRICE
84913	4 Row Kit	\$ 2601
84929	Kit without Toolbar	\$ 2447
Included Parts		Quantity
2x2 Toolbar - 72"		Qty: 2
Head Mounting Brackets		Qty: 4
Toolbar Splice		N/A

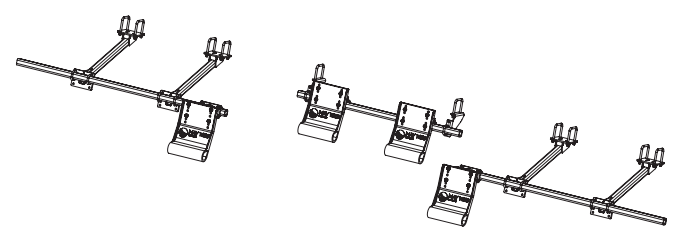

PART NO	DESCRIPTION	RETAIL PRICE
84914	4 Row Kit	\$ 2704
84930	Kit without Toolbar	\$ 2550
Included Parts		Quantity
2x2 Toolbar - 72"		Qty: 3
Head Mounting Brackets		Qty: 6
Toolbar Splice		N/A



G4 STALK STOMPERS

KITS FOR NEW HOLLAND 96C /98C /98D /996 SERIES: 8 & 12 ROW HEADS

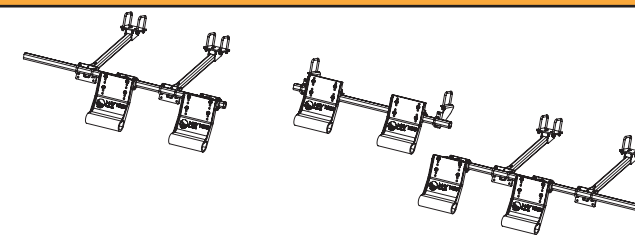

PART NO	DESCRIPTION	RETAIL PRICE
84915	6 Row Kit	\$ 3528
84931	Kit without Toolbar	\$ 3296
Included Parts		Quantity
2x2 Toolbar - 72"		Qty: 3
Head Mounting Brackets		Qty: 6
Toolbar Splice		N/A

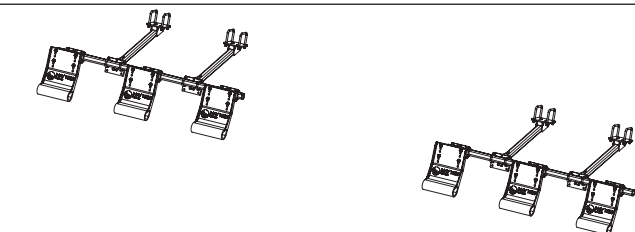

PART NO	DESCRIPTION	RETAIL PRICE
84916	6 Row Kit	\$ 3451
84932	Kit without Toolbar	\$ 3219
Included Parts		Quantity
2x2 Toolbar - 72"		Qty: 2
Head Mounting Brackets		Qty: 4
Toolbar Splice		N/A

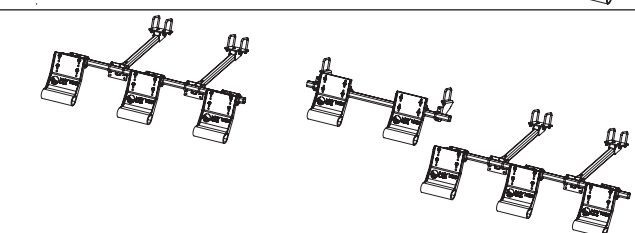

PART NO	DESCRIPTION	RETAIL PRICE
84917	8 Row Kit	\$ 4223
84933	Kit without Toolbar	\$ 3914
Included Parts		Quantity
2x2 Toolbar - 72"		Qty: 3
Head Mounting Brackets		Qty: 6
Toolbar Splice		N/A

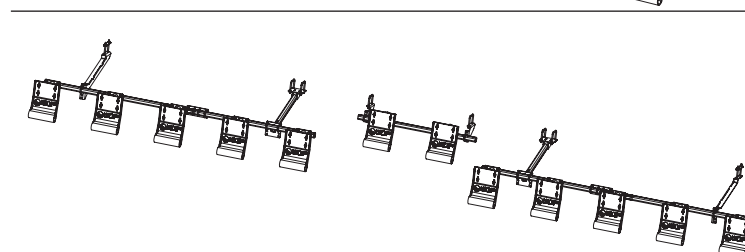

PART NO	DESCRIPTION	RETAIL PRICE
84918	12 Row Kit	\$ 5588
84934	Kit without Toolbar	\$ 5073
Included Parts		Quantity
2x2 Toolbar - 72"		Qty: 5
Head Mounting Brackets		Qty: 6
Toolbar Splice		Qty: 2

16 & 18 Row Kits Available. Contact May Wes or your dealer for ordering information.

The 2x2 toolbar is required but can be purchased locally to reduce shipping cost. This is standard 2x2 square 3/16" - sidewall tubing available from most fabrication shops or metal supply companies.

REPLACEMENT PARTS FOR NEW HOLLAND 96C /98C /98D /996 SERIES

<p>Single Row Shoe Assembly 43102 \$ 428 ea</p>	<p>Single Center Row Shoe Assembly 43115 \$ 428 ea</p>	<p>12" Shoe 24100 \$ 148 ea</p>	<p>Toolbar Splice 41827 \$ 63 ea</p>	<p>Torsion Unit 42295 \$ 206 ea</p>
<p>Header Bracket 42450 \$ 309 ea</p>	<p>Left End Header Bracket 42452 \$ 247 ea</p>	<p>Right End Header Bracket 42465 \$ 247 ea</p>	<p>Center Header Bracket 42454 \$ 83 ea</p>	<p>Bent Pin & Clip (2 pack) 42384 \$ 12 pk</p>
<p>Toolbar Mount Bracket 43101 \$ 125 ea</p>	<p>Center Row Toolbar Mount Bracket 43111 \$ 125 ea</p>	<p>2x2 Toolbar 72" 41672 \$ 124 ea</p> <p>102" 41673 \$ 181 ea</p>	<p>ORDER ONLINE 24/7</p>	



G4 STALK STOMPERS

KITS FOR JOHN DEERE C-SERIES
FITS MODELS: C6R/C8R/C12R/C12F/C16R/C18R

	PART NO	DESCRIPTION	RETAIL PRICE
	84767	2 Row Kit	\$ 1957
	84779	Kit without Toolbar	\$ 1751
Included Parts		Quantity	
		2x2 Toolbar - 72"	Qty: 2
		Head Mounting Brackets - Outer	Qty: 4
		Toolbar Splice	N/A
		End Support Kit	N/A
	84768	4 Row Kit	\$ 2472
	84780	Kit without Toolbar	\$ 2369
Included Parts		Quantity	
		2x2 Toolbar - 72"	Qty: 2
		Head Mounting Brackets - Outer	Qty: 4
		Toolbar Splice	N/A
		End Support Kit	N/A
	84769	6 Row Kit	\$ 3168
	84781	Kit without Toolbar	\$ 2962
Included Parts		Quantity	
		2x2 Toolbar - 102"	Qty: 2
		Head Mounting Brackets - Outer	Qty: 4
		Toolbar Splice	N/A
		End Support Kit	N/A
	84771	8 Row Kit *	\$ 4017
	84783	Kit without Toolbar *	\$ 3734
Included Parts		Quantity	
		2x2 Toolbar - 72"	Qty: 2
		- 102"	Qty: 2
		Head Mounting Brackets - Outer	Qty: 4
		- Inner	Qty: 4
		Toolbar Splice	Qty: 1
		End Support Kit	Qty: 1
	84772	12 Row Kit *	\$ 5408
	84784	Kit without Toolbar *	\$ 4996
Included Parts		Quantity	
		2x2 Toolbar - 72"	Qty: 3
		- 102"	Qty: 2
		Head Mounting Brackets - Outer	Qty: 4
		- Inner	Qty: 4
		Toolbar Splice	Qty: 3
		End Support Kit	Qty: 1
	84773	12 Row Kit for Folding Head *	\$ 5794
	84785	Kit without Toolbar *	\$ 5356
Included Parts		Quantity	
		2x2 Toolbar - 102"	Qty: 4
		Head Mounting Brackets - Outer	Qty: 2
		- Inner	Qty: 4
		Toolbar Splice	Qty: 1
		End Support Kit	Qty: 1



G4 STALK STOMPERS

KITS FOR JOHN DEERE C-SERIES
FITS MODELS: C6R/C8R/C12R/C12F/C16R/C18R

	PART NO	DESCRIPTION	RETAIL PRICE
	84774	16 Row Kit *	\$ 7185
	84786	Kit without Toolbar *	\$ 6721
Included Parts		Quantity	
		2x2 Toolbar - 102"	Qty: 6
		Head Mounting Brackets - Outer	Qty: 4
		- Inner	Qty: 4
		Toolbar Splice	Qty: 3
		End Support Kit	Qty: 1
	84775	16 Row Kit for Folding Head *	\$ 7751
	84787	Kit without Toolbar *	\$ 7288
Included Parts		Quantity	
		2x2 Toolbar - 102"	Qty: 5
		Head Mounting Brackets - Outer	Qty: 6
		- Inner	Qty: 4
		Toolbar Splice	Qty: 3
		End Support Kit	Qty: 1
	84776	18 Row Kit *	\$ 7803
	84788	Kit without Toolbar *	\$ 7313
Included Parts		Quantity	
		2x2 Toolbar - 102"	Qty: 5
		Head Mounting Brackets - Outer	Qty: 4
		- Inner	Qty: 4
		Toolbar Splice	Qty: 3
		End Support Kit	Qty: 1

Kit for 18 Row Folding Head also available. Contact your dealer or May Wes to order.

*Due to variation of implement configurations, row coverage under the feederhouse may not be applicable.
The 2x2 toolbar is required but can be purchased locally to reduce shipping cost.
This is standard 2x2 square 3/16" - sidewall tubing available from most fabrication shops or metal supply companies.

REPLACEMENT PARTS FOR JOHN DEERE C-SERIES

<p>Single Row Shoe Assembly 43102 \$ 428 ea</p>	<p>Single Center Row Shoe Assembly 43115 \$ 428 ea</p>	<p>12" Shoe 24100 \$ 148 ea</p>	<p>2x2 Toolbar 72" 41672 \$ 124 ea 102" 41673 \$ 181 ea</p>
<p>Outer Header Bracket 43170 \$ 161 ea</p>	<p>Inner Header Bracket 43169 \$ 161 ea</p>	<p>End Support Kit 42738 \$ 206 ea</p>	<p>Bent Pin & Clip (2 pack) 42384 \$ 12 pk</p>
<p>Torsion Unit 42295 \$ 206 ea</p>	<p>Toolbar Mount Bracket 43101 \$ 125 ea</p>	<p>Center Row Toolbar Mount Bracket 43111 \$ 125 ea</p>	<p>Toolbar Splice 41827 \$ 63 ea</p>



G4 STALK STOMPERS

KITS FOR JOHN DEERE 600 / 700 SERIES
 FITS MODELS: 606 / 706, 608 / 708, 612 / 712, 616 / 716, 618 / 718

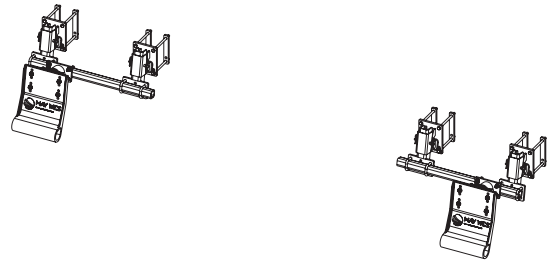

PART NO	DESCRIPTION	RETAIL PRICE
84624	2 Row Kit	\$ 1803
84631	Kit without Toolbar	\$ 1597
Included Parts		Quantity
2x2 Toolbar - 72"		Qty: 2
Head Mounting Brackets		Qty: 4
Toolbar Splice		N/A
End Support Kit		OPTIONAL

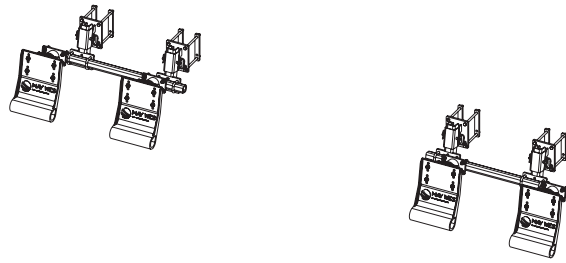

PART NO	DESCRIPTION	RETAIL PRICE
84625	4 Row Kit	\$ 2369
84632	Kit without Toolbar	\$ 2112
Included Parts		Quantity
2x2 Toolbar - 72"		Qty: 2
Head Mounting Brackets		Qty: 4
Toolbar Splice		N/A
End Support Kit		OPTIONAL

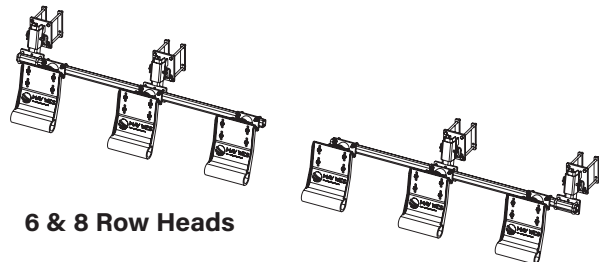

6 & 8 Row Heads

PART NO	DESCRIPTION	RETAIL PRICE
84626	6 Row Kit for 6 & 8 Row Heads *	\$ 3142
84633	Kit without Toolbar *	\$ 2962
Included Parts		Quantity
2x2 Toolbar - 102"		Qty: 2
Head Mounting Brackets		Qty: 4
Toolbar Splice		N/A
End Support Kit		OPTIONAL

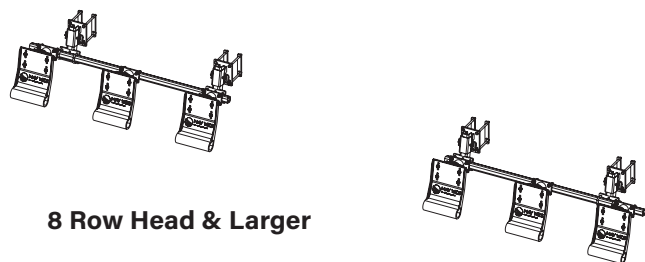

8 Row Head & Larger

PART NO	DESCRIPTION	RETAIL PRICE
84626	6 Row Kit for 8 Row or Larger Heads *	\$ 3142
84633	Kit without Toolbar *	\$ 2962
Included Parts		Quantity
2x2 Toolbar - 102"		Qty: 2
Head Mounting Brackets		Qty: 4
Toolbar Splice		N/A
End Support Kit		OPTIONAL

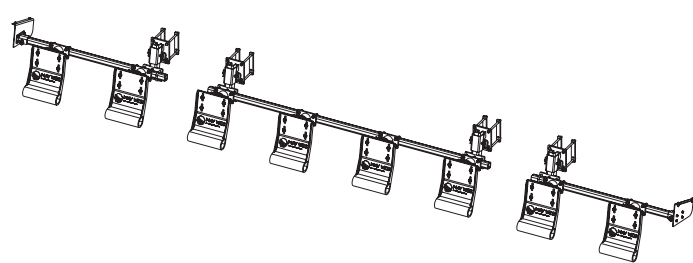

PART NO	DESCRIPTION	RETAIL PRICE
84627	8 Row Kit *	\$ 3914
84634	Kit without Toolbar *	\$ 3683
Included Parts		Quantity
2x2 Toolbar - 102"		Qty: 3
Head Mounting Brackets		Qty: 4
Toolbar Splice		Qty: 2
End Support Kit		Qty: 1

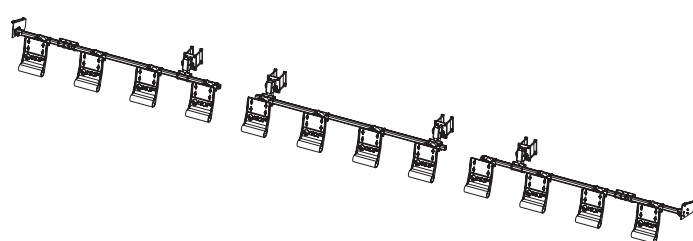

PART NO	DESCRIPTION	RETAIL PRICE
84628	12 Row Kit *	\$ 5356
84635	Kit without Toolbar *	\$ 4816
Included Parts		Quantity
2x2 Toolbar - 72"		Qty: 2
2x2 Toolbar - 102"		Qty: 3
Head Mounting Brackets		Qty: 4
Toolbar Splice		Qty: 2
End Support Kit		Qty: 1



G4 STALK STOMPERS

KITS FOR JOHN DEERE 600 / 700 SERIES
 FITS MODELS: 606 / 706, 608 / 708, 612 / 712, 616 / 716, 618 / 718

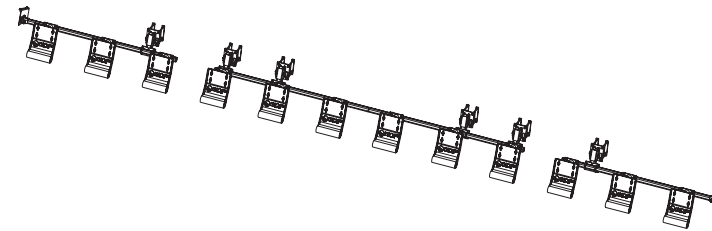

PART NO	DESCRIPTION	RETAIL PRICE
84870	12 Row Kit for Folding Head *	\$ 5768
84871	Kit without Toolbar *	\$ 5253
Included Parts		Quantity
2x2 Toolbar - 72"		Qty: 2
2x2 Toolbar - 102"		Qty: 3
Head Mounting Brackets		Qty: 6
Toolbar Splice		Qty: 2
End Support Kit		Qty: 1

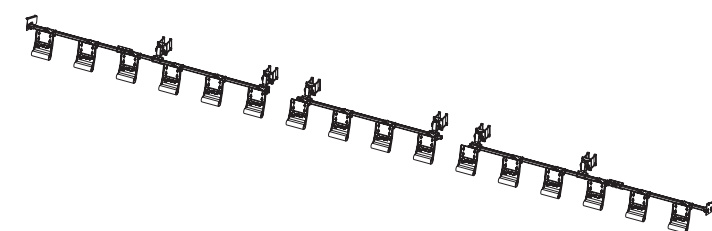

PART NO	DESCRIPTION	RETAIL PRICE
84629	16 Row Kit *	\$ 6644
84636	Kit without Toolbar *	\$ 6026
Included Parts		Quantity
2x2 Toolbar - 102"		Qty: 5
Head Mounting Brackets		Qty: 6
Toolbar Splice		Qty: 2
End Support Kit		Qty: 1

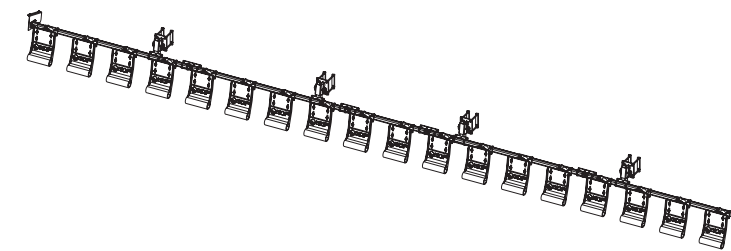

PART NO	DESCRIPTION	RETAIL PRICE
84630	18 Row Kit	\$ 6979
84637	Kit without Toolbar	\$ 6412
Included Parts		Quantity
2x2 Toolbar - 72"		Qty: 2
2x2 Toolbar - 102"		Qty: 3
Head Mounting Brackets		Qty: 4
Toolbar Splice		Qty: 2
End Support Kit		Qty: 1

*Due to variation of implement configurations, row coverage under the feederhouse may not be applicable.

The 2x2 toolbar is required but can be purchased locally to reduce shipping cost.

This is standard 2x2 square 3/16" - sidewall tubing available from most fabrication shops or metal supply companies.

REPLACEMENT PARTS FOR JOHN DEERE 600 / 700 SERIES

<p>Single Row Shoe Assembly 43102 \$ 428 ea</p>	<p>12" Shoe 24100 \$ 148 ea</p>	<p>2x2 Toolbar - 72" 41672 \$ 124 ea 2x2 Toolbar - 102" 41673 \$ 181 ea</p>
<p>Toolbar Mount Bracket 43101 \$ 125 ea</p>	<p>Head Mounting Bracket 41848 \$ 182 ea</p>	<p>Bent Pin & Clip (2 pack) 42384 \$ 12 pk</p>
<p>Vertical Bracket 41834 \$ 109 ea</p>	<p>End Support Kit 42534 \$ 187 ea</p>	<p>Toolbar Splice 41827 \$ 63 ea</p>
		<p>Torsion Unit 42295 \$ 206 ea</p>

INSTALLATION VIDEO
John Deere 600/700 Series

SCAN ME

Featuring Minnesota Millennial Farmer

INSTALLATION VIDEO
John Deere 712FC 12-Row Folding Head

SCAN ME

Featuring Larson Farms

Scan the QR codes with your smartphone to watch on YouTube.



G4 STALK STOMPERS

KITS FOR JOHN DEERE 90 / 40 SERIES

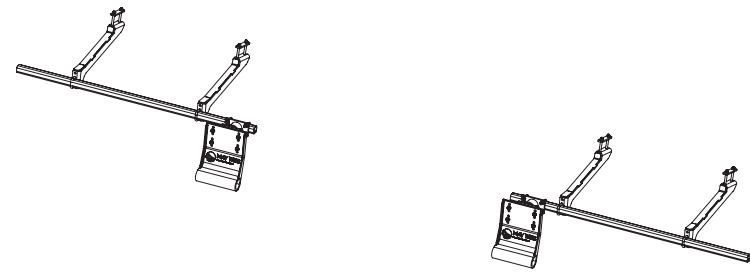

PART NO	DESCRIPTION	RETAIL PRICE
84965	2 Row Kit (2 Outer Rows)	\$ 1751
84973	Kit without Toolbar	\$ 1545
Included Parts		Quantity
2x2 Toolbar - 72"		Qty: 2
Head Mounting Brackets		Qty: 4
Toolbar Splice		N/A

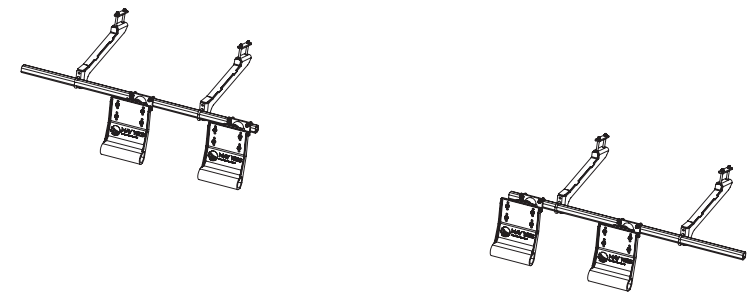

PART NO	DESCRIPTION	RETAIL PRICE
84966	4 Row Kit (4 Outer Rows)	\$ 2421
84974	Kit without Toolbar	\$ 2215
Included Parts		Quantity
2x2 Toolbar - 72"		Qty: 2
Head Mounting Brackets		Qty: 4
Toolbar Splice		N/A

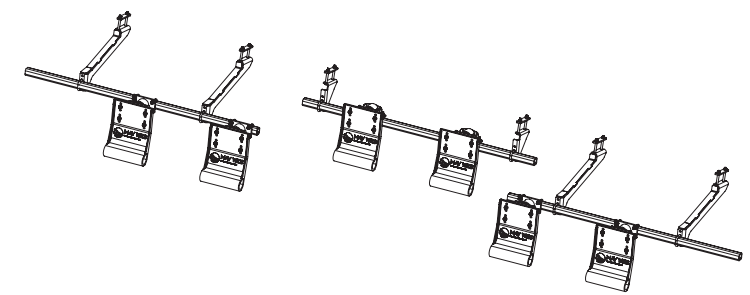

PART NO	DESCRIPTION	RETAIL PRICE
84968	6 Row Kit (4 Outer Rows & 2 Inner Rows)	\$ 3348
84976	Kit without Toolbar	\$ 3090
Included Parts		Quantity
2x2 Toolbar - 72"		Qty: 3
Head Mounting Brackets		Qty: 6
Toolbar Splice		N/A

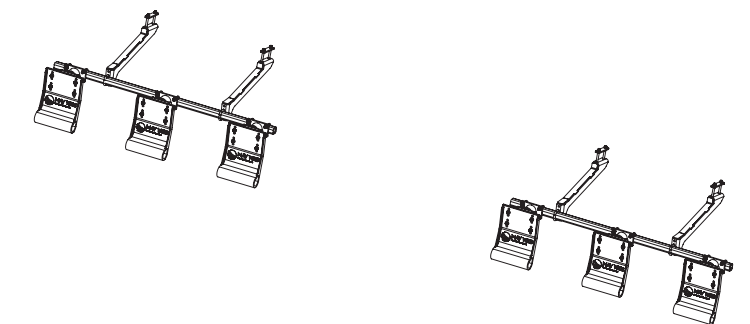

PART NO	DESCRIPTION	RETAIL PRICE
84969	6 Row Kit (6 Outer Rows)	\$ 3245
84977	Kit without Toolbar	\$ 3039
Included Parts		Quantity
2x2 Toolbar - 72"		Qty: 2
Head Mounting Brackets		Qty: 4
Toolbar Splice		N/A

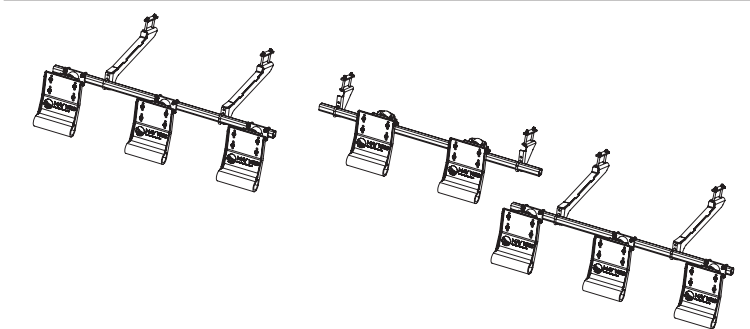

PART NO	DESCRIPTION	RETAIL PRICE
84970	8 Row Kit (6 Outer Rows & 2 Inner Rows)	\$ 3708
84978	Kit without Toolbar	\$ 3425
Included Parts		Quantity
2x2 Toolbar - 72"		Qty: 3
Head Mounting Brackets		Qty: 6
Toolbar Splice		N/A



G4 STALK STOMPERS

KITS FOR JOHN DEERE 90 / 40 SERIES

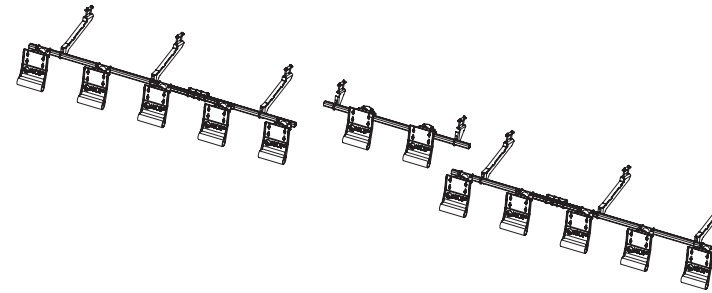

PART NO	DESCRIPTION	RETAIL PRICE
84971	12 Row Kit (10 Outer Rows & 2 Inner Rows)	\$ 5253
84979	Kit without Toolbar	\$ 4790
Included Parts		Quantity
2x2 Toolbar - 72"		Qty: 5
Head Mounting Brackets		Qty: 8
Toolbar Splice		Qty: 2

The 2x2 toolbar is required but can be purchased locally to reduce shipping cost. This is standard 2x2 square 3/16" - sidewall tubing available from most fabrication shops or metal supply companies.

REPLACEMENT PARTS FOR JOHN DEERE 90 / 40 SERIES

<p>Single Row Shoe Assembly 43102 \$ 428 ea</p>	<p>Single Center Row Shoe Assembly 43115 \$ 428 ea</p>	<p>12" Shoe 24100 \$ 148 ea</p>	<p>2x2 Toolbar 72" 41672 \$ 124 ea 102" 41673 \$ 181 ea</p>
<p>Outer Header Bracket 42471 \$ 247 ea</p>	<p>Inner Header Bracket 42475 \$ 83 ea</p>	<p>Toolbar Splice 41827 \$ 63 ea</p>	<p>Bent Pin & Clip (2 pack) 42384 \$ 12 pk</p>
<p>Torsion Unit 42295 \$ 206 ea</p>	<p>Toolbar Mount Bracket 43101 \$ 125 ea</p>	<p>Center Row Toolbar Mount Bracket 43111 \$ 125 ea</p>	<p>ORDER ONLINE 24/7</p>



GVL POLY CORN SNOOTS
page 101



SNOUT SAVERS & SNOOT BOOTS
PREVENT DAMAGE TO POLY CORN SNOOTS
page 107



G4 STALK STOMPERS

KITS FOR DRAGO GT SERIES

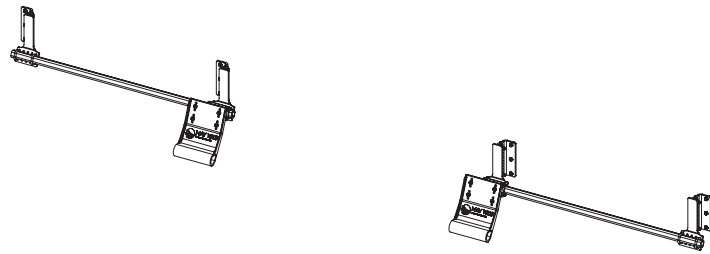

PART NO	DESCRIPTION	RETAIL PRICE
84639	2 Row Kit ▲	\$ 1803
84646	Kit without Toolbar ▲	\$ 1623
Included Parts		Quantity
2x2 Toolbar - 72"		Qty: 2
Head Mounting Brackets		Qty: 4
Toolbar Splice		N/A

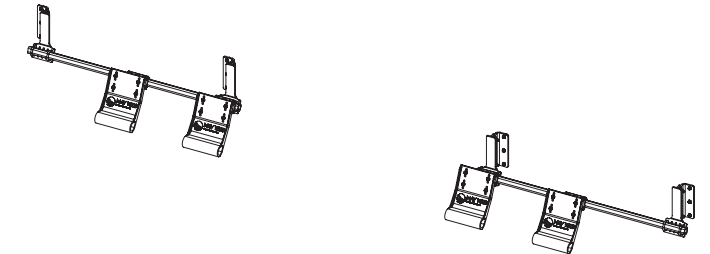

PART NO	DESCRIPTION	RETAIL PRICE
84640	4 Row Kit ▲	\$ 2369
84647	Kit without Toolbar ▲	\$ 2138
Included Parts		Quantity
2x2 Toolbar - 72"		Qty: 2
Head Mounting Brackets		Qty: 4
Toolbar Splice		N/A

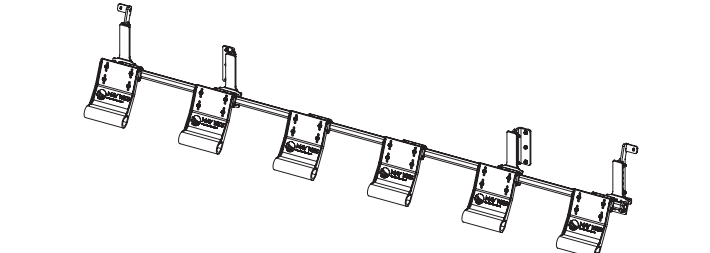

PART NO	DESCRIPTION	RETAIL PRICE
84804	6 Row Kit	\$ 3245
84805	Kit without Toolbar	\$ 2987
Included Parts		Quantity
2x2 Toolbar - 102"		Qty: 2
Head Mounting Brackets		Qty: 2
GT 6-Row Head Mounting Brackets		Qty: 2
Toolbar Splice		N/A

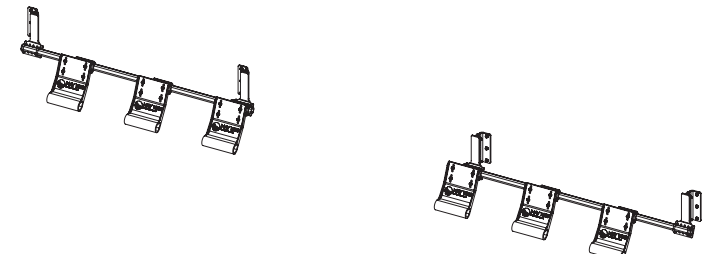

PART NO	DESCRIPTION	RETAIL PRICE
84641	6 Row Kit for 8 Row or Larger Heads	\$ 3245
84648	Kit without Toolbar	\$ 2987
Included Parts		Quantity
2x2 Toolbar - 102"		Qty: 2
Head Mounting Brackets		Qty: 4
Toolbar Splice		N/A

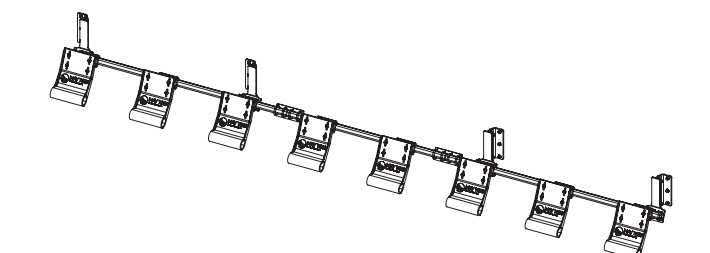

PART NO	DESCRIPTION	RETAIL PRICE
84642	8 Row Kit *	\$ 3966
84649	Kit without Toolbar *	\$ 3708
Included Parts		Quantity
2x2 Toolbar - 102"		Qty: 3
Head Mounting Brackets		Qty: 4
Toolbar Splice		Qty: 2

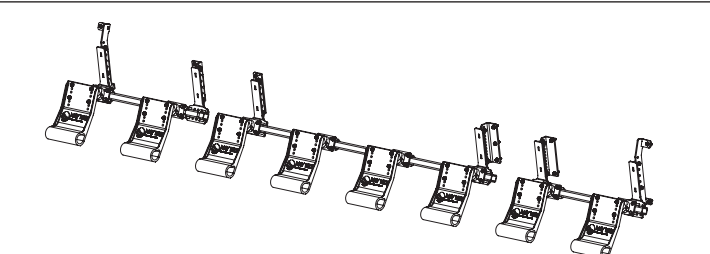

PART NO	DESCRIPTION	RETAIL PRICE
84802	8 Row Kit for Folding Head *	\$ 4172
84803	Kit without Toolbar *	\$ 3914
Included Parts		Quantity
2x2 Toolbar - 72"		Qty: 2
- 102"		Qty: 1
Head Mounting Brackets		Qty: 6
Toolbar Splice		N/A

▲ GT 6-Row heads require Header Bracket not included in 2-Row and 4-Row kits. Order separately if covering only 2 or 4 rows on a 6-Row head.
 * Due to variation of implement configurations, row coverage under the feederhouse may not be applicable.



G4 STALK STOMPERS

KITS FOR DRAGO GT SERIES

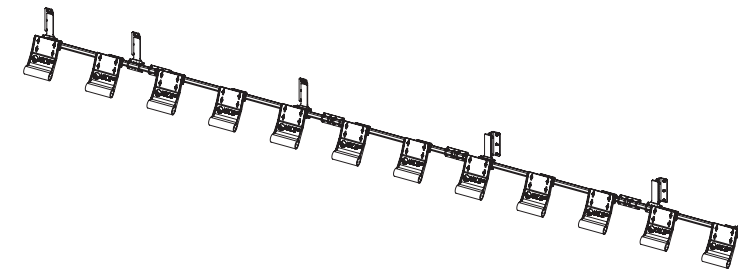

PART NO	DESCRIPTION	RETAIL PRICE
84643	12 Row Kit *	\$ 5305
84650	Kit without Toolbar *	\$ 4867
Included Parts		Quantity
2x2 Toolbar - 72"		Qty: 2
- 102"		Qty: 3
Head Mounting Brackets		Qty: 6
Toolbar Splice		Qty: 4

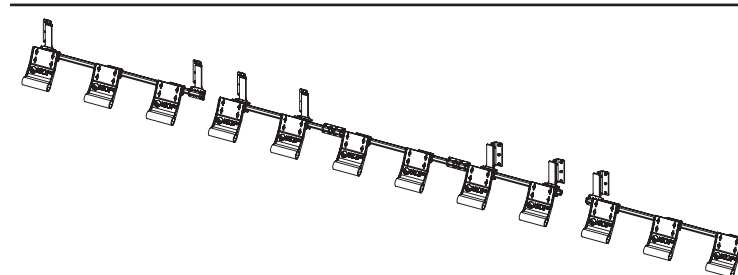

PART NO	DESCRIPTION	RETAIL PRICE
84753	12 Row Kit for Folding Head *	\$ 5794
84754	Kit without Toolbar *	\$ 5253
Included Parts		Quantity
2x2 Toolbar - 72"		Qty: 2
- 102"		Qty: 3
Head Mounting Brackets		Qty: 8
Toolbar Splice		Qty: 2

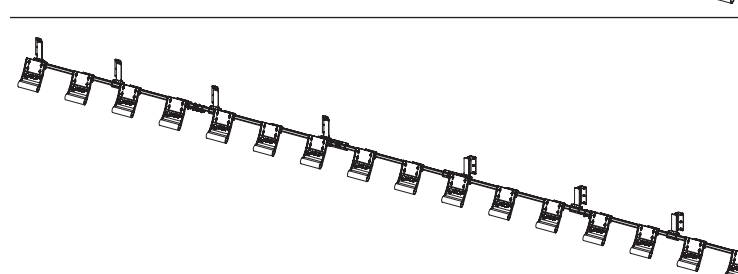

PART NO	DESCRIPTION	RETAIL PRICE
84644	16 Row Kit *	\$ 6335
84651	Kit without Toolbar *	\$ 5665
Included Parts		Quantity
2x2 Toolbar - 102"		Qty: 5
Head Mounting Brackets		Qty: 8
Toolbar Splice		Qty: 4

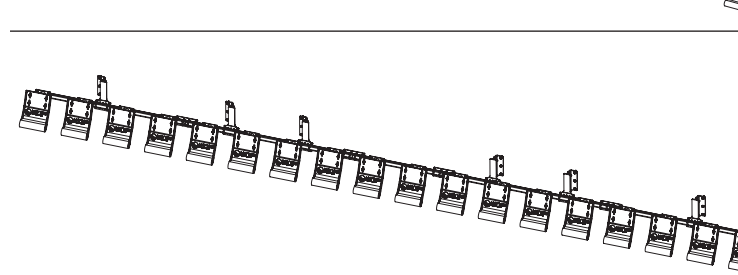

PART NO	DESCRIPTION	RETAIL PRICE
84645	18 Row Kit *	\$ 6979
84652	Kit without Toolbar *	\$ 6489
Included Parts		Quantity
2x2 Toolbar - 72"		Qty: 2
- 102"		Qty: 3
Head Mounting Brackets		Qty: 6
Toolbar Splice		Qty: 4

▲ GT 6-Row heads require Header Bracket not included in 2-Row and 4-Row kits. Order separately if covering only 2 or 4 rows on a 6-Row head.
 *Due to variation of implement configurations, row coverage under the feederhouse may not be applicable.

The 2x2 toolbar is required but can be purchased locally to reduce shipping cost.
 This is standard 2x2 square 3/16" - sidewall tubing available from most fabrication shops or metal supply companies.

REPLACEMENT PARTS FOR DRAGO GT SERIES

<p>Single Row Shoe Assembly 43102 \$ 428 ea</p>	<p>12" Shoe 24100 \$ 148 ea</p>	<p>Toolbar Mount Bracket 43101 \$ 125 ea</p>	<p>2x2 Toolbar 72" 41672 \$ 124 ea 102" 41673 \$ 181 ea</p>
<p>Torsion Unit 42295 \$ 206 ea</p>	<p>Head Mounting Bracket 42282 \$ 232 ea</p>	<p>GT 6-Row Header Brackets ▲ 42420 \$ 315 pr</p>	<p>8-Row Folding Header Bracket 42496 \$ 243 ea</p> <p>Toolbar Splice 41827 \$ 63 ea</p>

▲ GT 6-Row heads require Header Bracket not included in 2-Row and 4-Row kits. Order separately if covering only 2 or 4 rows on a 6-Row head.

INSTALLATION VIDEO
 Drago GT

SCAN ME

Scan the QR code with your smartphone to watch on YouTube.



G4 STALK STOMPERS

KITS FOR DRAGO SERIES I & II

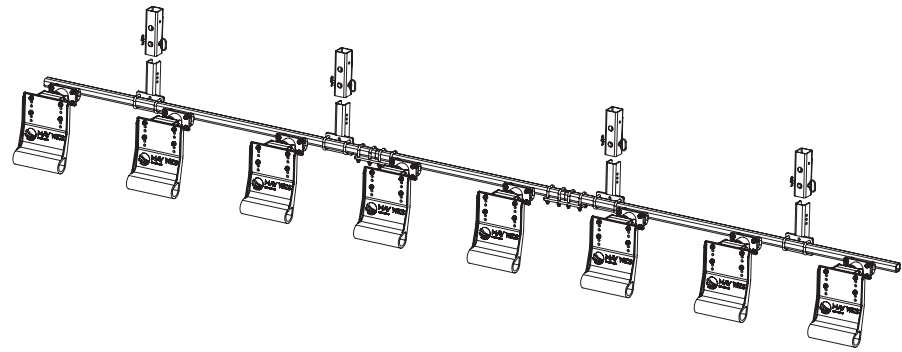

TOOLBAR ASSEMBLY KITS

Number of Rows	Kit Part No	Retail Price	2x2 Toolbar	Head Mounting Brackets	Toolbar Splice
WITH TOOLBAR					
<i>NOTE: Toolbar configuration based on 30" rows; kit will accommodate narrower rows.</i>					
2-Row ⚠	84653	\$ 1700	72" (Qty 2)	Qty 4 ea	N/A
4-Row ⚠	84654	\$ 2189	72" (Qty 2)	Qty 4 ea	N/A
6-Row * ⚠	84655	\$ 3013	102" (Qty 2)	Qty 4 ea	N/A
8-Row *	84656	\$ 3863	102" (Qty 3)	Qty 4 ea	Qty 2 ea
12-Row *	84657	\$ 5073	102" (Qty 3) + 72" (Qty 2)	Qty 4 ea	Qty 2 ea
12-Row Folding *	84659	\$ 5871	102" (Qty 1) + 72" (Qty 4)	Qty 8 ea	Qty 2 ea
16-Row *	84660	\$ 6103	102" (Qty 5)	Qty 4 ea	Qty 4 ea
18-Row *	84661	\$ 6979	102" (Qty 3) + 72" (Qty 2)	Qty 8 ea	Qty 4 ea

Number of Rows	Kit Part No	Retail Price	2x2 Toolbar	Head Mounting Brackets	Toolbar Splice
WITHOUT TOOLBAR					
<i>The 2x2 toolbar is required but can be purchased locally to reduce shipping cost. This is standard 2x2 square 3/16" - sidewall tubing available from most fabrication shops or metal supply companies.</i>					
2-Row ⚠	84662	\$ 1468	N/A	Qty 4 ea	N/A
4-Row ⚠	84663	\$ 2009	N/A	Qty 4 ea	N/A
6-Row * ⚠	84664	\$ 2859	N/A	Qty 4 ea	N/A
8-Row *	84665	\$ 3554	N/A	Qty 4 ea	Qty 2 ea
12-Row *	84666	\$ 4584	N/A	Qty 4 ea	Qty 2 ea
12-Row Folding *	84668	\$ 5382	N/A	Qty 8 ea	Qty 2 ea
16-Row *	84669	\$ 5614	N/A	Qty 4 ea	Qty 2 ea
18-Row *	84670	\$ 6438	N/A	Qty 8 ea	Qty 2 ea

*Due to variation of implement configurations, row coverage under the feederhouse may not be applicable.
 ⚠ Series II 6 Row heads require below Offset Bracket not included in the kit. (Also applicable if covering only 2 or 4 rows on a 6 Row head.)

REPLACEMENT PARTS FOR DRAGO SERIES I & II

 Single Row Assembly 43102 \$ 428 ea	 12" Shoe 24100 \$ 148 ea	 2x2 Toolbar 72" 41672 \$124 ea 102" 41673 \$181 ea <i>Lengths available</i>	 Head Mounting Bracket 41788 \$ 160 ea	 Vertical Bracket 41834 \$ 109 ea	 Toolbar Splice 41827 \$ 63 ea	 Series II 6 Row Offset Brackets ⚠ 41958 \$ 165 pr
--	---------------------------------	--	--	---	--------------------------------------	--



G4 STALK STOMPERS

KITS FOR HARVESTEC 5000 & 6000 SERIES

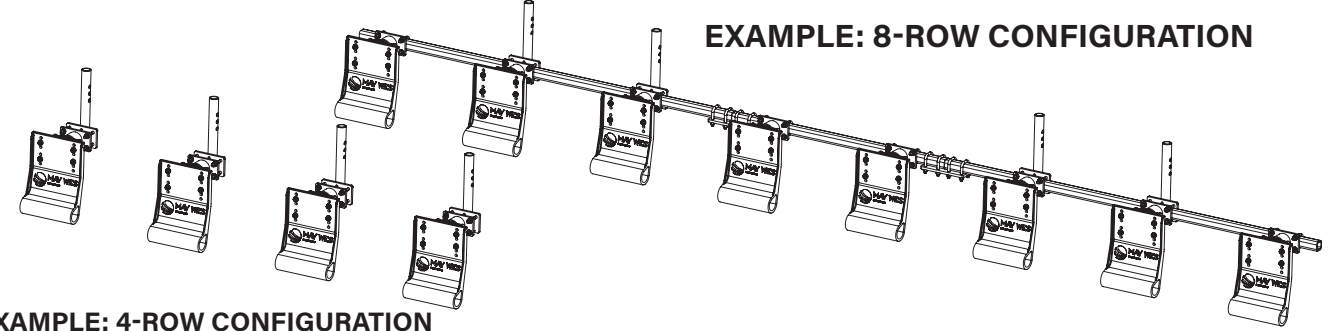

EXAMPLE: 8-ROW CONFIGURATION

EXAMPLE: 4-ROW CONFIGURATION
 (Mount directly to header brackets, applies to 2-row and 4-row kits.)

TOOLBAR ASSEMBLY KITS

Number of Rows	Kit Part No	Retail Price	2x2 Toolbar	Head Mounting Brackets	Toolbar Splice
WITH TOOLBAR					
<i>NOTE: Toolbar configuration based on 30" rows; kit will accommodate narrower rows.</i>					
2-Row *	84721	\$ 1082	Not Required	Qty 2 ea	N/A
4-Row *	84722	\$ 1932	Not Required	Qty 4 ea	N/A
6-Row **	84723	\$ 2884	102" (Qty 2)	Qty 4 ea	N/A
8-Row **	84724	\$ 3863	102" (Qty 3)	Qty 4 ea	Qty 2 ea
12-Row **	84725	\$ 5047	102" (Qty 3) + 72" (Qty 2)	Qty 4 ea	Qty 4 ea
WITHOUT TOOLBAR					
<i>The 2x2 toolbar is required but can be purchased locally to reduce shipping cost. This is standard 2x2 square 3/16" - sidewall tubing available from most fabrication shops or metal supply companies.</i>					
6-Row **	84726	\$ 2678	N/A	Qty 4 ea	N/A
8-Row **	84727	\$ 3528	N/A	Qty 4 ea	Qty 2 ea
12-Row **	84728	\$ 4584	N/A	Qty 4 ea	Qty 2 ea

*Toolbar not required for 2-Row and 4-Row applications.
 **Due to variation of implement configurations, row coverage under the feederhouse may not be applicable.

REPLACEMENT PARTS FOR HARVESTEC 5000 & 6000 SERIES

 Single Row Shoe Assembly 43102 \$ 428 ea	 12" Shoe 24100 \$ 148 ea	 2x2 Toolbar 72" 41672 \$ 124 ea 102" 41673 \$ 181 ea	 Head Mounting Bracket 41957 \$ 129 ea
 Toolbar Mount Bracket 43101 \$ 125 ea	 Torsion Unit 42295 \$ 206 ea	 Toolbar Splice 41827 \$ 63 ea	 Bent Pin & Clip (2 pack) 42384 \$ 12 pk

G4 STALK STOMPERS

KITS FOR MACDON C-SERIES



PART NO	DESCRIPTION	RETAIL PRICE
84756	2 Row Kit (No Toolbar Required)	\$ 1082

Included Parts	Quantity
2x2 Toolbar	N/A
Head Mounting Brackets	Qty: 2
Toolbar Splice	N/A

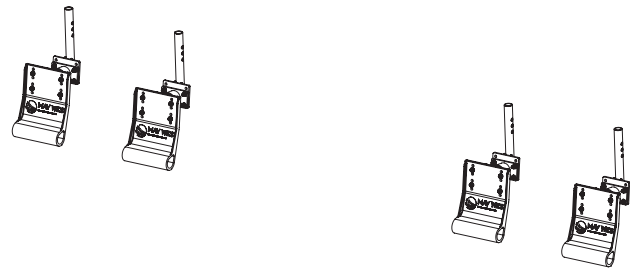

PART NO	DESCRIPTION	RETAIL PRICE
84757	4 Row Kit (No Toolbar Required)	\$ 1932

Included Parts	Quantity
2x2 Toolbar	N/A
Head Mounting Brackets	Qty: 4
Toolbar Splice	N/A

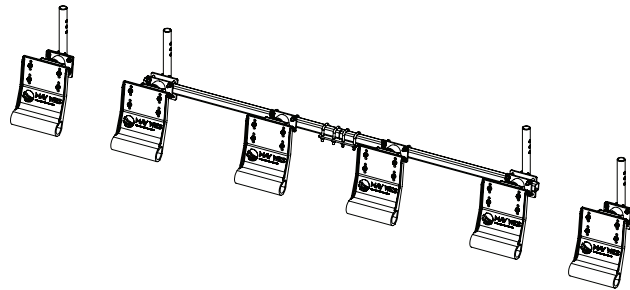

PART NO	DESCRIPTION	RETAIL PRICE
84758	6 Row Kit *	\$ 2884
84761	Kit without Toolbar	\$ 2678

Included Parts	Quantity
2x2 Toolbar - 102"	Qty: 2
Head Mounting Brackets	Qty: 4
Toolbar Splice	N/A

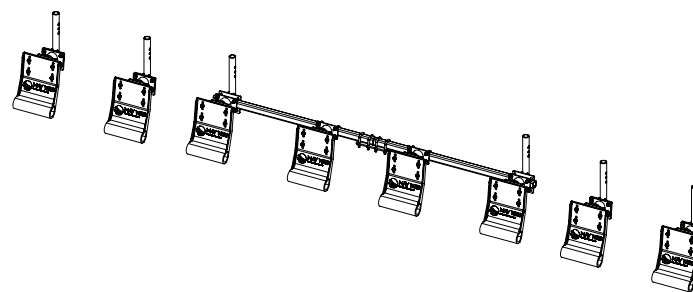

PART NO	DESCRIPTION	RETAIL PRICE
84759	8 Row Kit *	\$ 4017
84762	Kit without Toolbar	\$ 3708

Included Parts	Quantity
2x2 Toolbar - 72"	Qty: 2
Head Mounting Brackets	Qty: 6
Toolbar Splice	Qty: 1

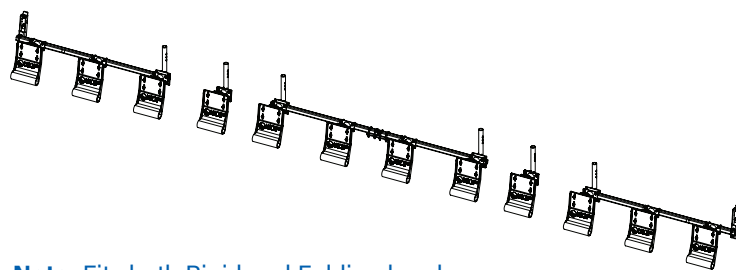

PART NO	DESCRIPTION	RETAIL PRICE
84760	12 Row Kit	\$ 5228
84763	Kit without Toolbar	\$ 4738

Included Parts	Quantity
2x2 Toolbar - 72"	Qty: 2
- 102"	Qty: 2
Head Mounting Brackets	Qty: 6
Toolbar Splice	Qty: 1
End Support Kit	Qty: 1

Note: Fits both Rigid and Folding heads.

*Due to variation of implement configurations, row coverage under the feederhouse may not be applicable.

The 2x2 toolbar is required but can be purchased locally to reduce shipping cost.

This is standard 2x2 square 3/16" - sidewall tubing available from most fabrication shops or metal supply companies.

G4 STALK STOMPERS

REPLACEMENT PARTS FOR MACDON C-SERIES

<p>Single Row Shoe Assembly 43102 \$ 428 ea</p>	<p>12" Shoe 24100 \$ 148 ea</p>	<p>Toolbar Mount Bracket 43101 \$ 125 ea</p>	<p>2x2 Toolbar 72" 41672 \$ 124 ea 102" 41673 \$ 181 ea</p>
<p>Torsion Unit 42295 \$ 206 ea</p>	<p>Header Bracket 42727 \$ 247 ea</p>	<p>End Support Kit 42735 \$ 253 pr</p>	<p>Toolbar Splice 41827 \$ 63 ea</p> <p>Bent Pin & Clip (2 pack) 42384 \$ 12 pk</p>

NEW PRODUCTS AVAILABLE NOW



Skid Hitch
Universal 2" Skidloader Hitch Receiver
ON PAGE 145



EXPANDED LINEUP

Kernel Keeper
"Cushion & Capture"
ON PAGES 109-110



LOCK N LUBE®
AND LOCK N FLATE®
ON PAGE 145



G2 STAR CLOSING WHEELS
ON PAGE 137

CUTTERBAR SKID SHOES FOR CASE IH, MACDON, NEW HOLLAND

STARTING ON PAGE 49



Mini Combine™ Harvester
ON PAGE 100

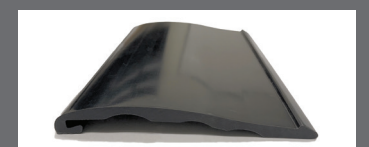

Cutterbar Skid Shoe for Honey Bee
ON PAGE 89



G4 STALK STOMPERS

KITS FOR GERINGHOFF HORIZON SERIES

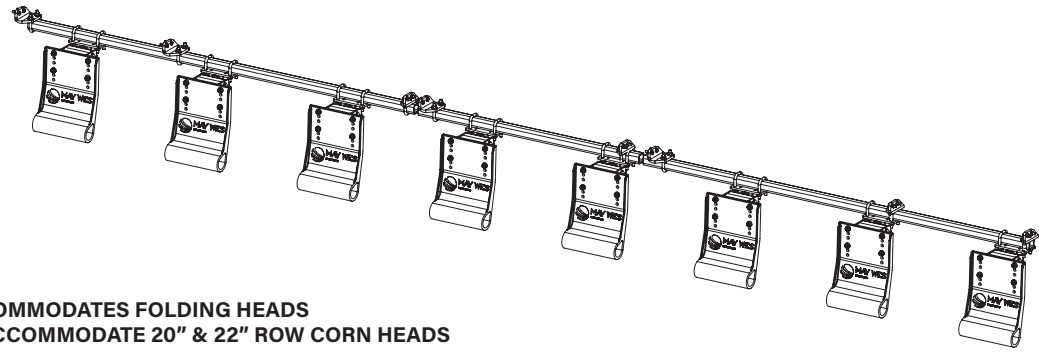

NOTE: ACCOMMODATES FOLDING HEADS
MAY NOT ACCOMMODATE 20" & 22" ROW CORN HEADS

TOOLBAR ASSEMBLY KITS

Number of Rows	Kit Part No	Retail Price	2x2 Toolbar	Head Mounting Brackets	Toolbar Splice
----------------	-------------	--------------	-------------	------------------------	----------------

WITH TOOLBAR

NOTE: Toolbar configuration based on 30" rows; kit will accommodate narrower rows.

2-Row	84685	\$ 1314	72" (Qty 2)	Qty 2 ea	N/A
4-Row	84686	\$ 1932	72" (Qty 2)	Qty 2 ea	N/A
6-Row *	84687	\$ 2884	102" (Qty 2)	Qty 4 ea	N/A
8-Row *	84688	\$ 3863	102" (Qty 2) + 72" (Qty 1)	Qty 4 ea	Optional
12-Row *	84689	\$ 5047	102" (Qty 4)	Qty 6 ea	Optional
16-Row *	84690	\$ 5974	102" (Qty 5)	Qty 6 ea	Optional
18-Row *	84691	\$ 6824	102" (Qty 5)	Qty 8 ea	Optional

WITHOUT TOOLBAR

The 2x2 toolbar is required but can be purchased locally to reduce shipping cost.
This is standard 2x2 square 3/16" - sidewall tubing available from most fabrication shops or metal supply companies.

2-Row	84692	\$ 1133	N/A	Qty 2 ea	N/A
4-Row	84693	\$ 1726	N/A	Qty 2 ea	N/A
6-Row *	84694	\$ 2678	N/A	Qty 4 ea	N/A
8-Row *	84695	\$ 3554	N/A	Qty 4 ea	Optional
12-Row *	84696	\$ 4532	N/A	Qty 6 ea	Optional
16-Row *	84697	\$ 5434	N/A	Qty 6 ea	Optional
18-Row *	84698	\$ 6232	N/A	Qty 8 ea	Optional

*Due to variation of implement configurations, row coverage under the feederhouse may not be applicable.

REPLACEMENT PARTS FOR GERINGHOFF HORIZON SERIES

<p>Single Row Shoe Assembly 43115 \$ 428 ea</p>	<p>12" Shoe 24100 \$ 148 ea</p>	<p>2x2 Toolbar 72" 41672 \$ 124 ea 102" 41673 \$ 181 ea</p>	<p>Torsion Unit 42295 \$ 206 ea</p>
<p>Right Head Mounting Bracket 42134 \$ 78 ea</p>	<p>Left Head Mounting Bracket 42135 \$ 78 ea</p>	<p>Offset Toolbar Mount Bracket 43111 \$ 125 ea</p>	<p>Bent Pin & Clip (2 pack) 42384 \$ 12 pk</p>

INSTALLATION VIDEO
Geringhoff Horizon
12-Row Folding

SCAN ME

Featuring
Larson Farms



G4 STALK STOMPERS

KITS FOR GERINGHOFF PATRIOT / NORTHSTAR / ROTA DISC SERIES

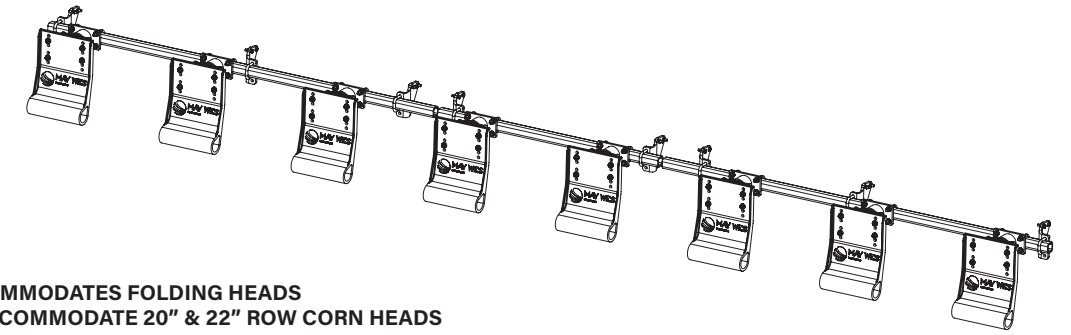

NOTE: ACCOMMODATES FOLDING HEADS
MAY NOT ACCOMMODATE 20" & 22" ROW CORN HEADS

TOOLBAR ASSEMBLY KITS

Number of Rows	Kit Part No	Retail Price	2x2 Toolbar	Head Mounting Brackets	Toolbar Splice	End Support Kit
----------------	-------------	--------------	-------------	------------------------	----------------	-----------------

WITH TOOLBAR

NOTE: Toolbar configuration based on 30" rows; kit will accommodate narrower rows.

2-Row	84671	\$ 1314	72" (Qty 2)	Qty 4 ea	N/A	Optional
4-Row	84672	\$ 1932	72" (Qty 2)	Qty 4 ea	N/A	Optional
6-Row *	84673	\$ 2884	102" (Qty 2)	Qty 8 ea	N/A	Optional
8-Row *	84674	\$ 3863	102" (Qty 2) + 72" (Qty 1)	Qty 8 ea	Optional	Qty 1 ea
12-Row *	84675	\$ 5047	102" (Qty 4)	Qty 12 ea	Optional	Optional
16-Row *	84676	\$ 5974	102" (Qty 5)	Qty 12 ea	Optional	Optional
18-Row *	84677	\$ 6901	102" (Qty 5)	Qty 16 ea	Optional	Optional

WITHOUT TOOLBAR

The 2x2 toolbar is required but can be purchased locally to reduce shipping cost.
This is standard 2x2 square 3/16" - sidewall tubing available from most fabrication shops or metal supply companies.

2-Row	84678	\$ 1133	N/A	Qty 4 ea	N/A	Optional
4-Row	84679	\$ 1726	N/A	Qty 4 ea	N/A	Optional
6-Row *	84680	\$ 2678	N/A	Qty 8 ea	N/A	Optional
8-Row *	84681	\$ 3554	N/A	Qty 8 ea	Optional	Qty 1 ea
12-Row *	84682	\$ 4532	N/A	Qty 12 ea	Optional	Optional
16-Row *	84683	\$ 5434	N/A	Qty 12 ea	Optional	Optional
18-Row *	84684	\$ 6361	N/A	Qty 16 ea	Optional	Optional

*Due to variation of implement configurations, row coverage under the feederhouse may not be applicable.

REPLACEMENT KITS FOR GERINGHOFF PATRIOT / NORTHSTAR / ROTA DISC SERIES

<p>Single Row Shoe Assembly 43102 \$ 428 ea</p>	<p>12" Shoe 24100 \$ 148 ea</p>	<p>2x2 Toolbar 72" 41672 \$ 124 ea 102" 41673 \$ 181 ea</p>	<p>Head Mounting Bracket Assembly 42375 \$ 109 ea</p>
<p>Toolbar Mount Bracket 43101 \$ 125 ea</p>	<p>Bent Pin & Clip (2 pack) 42384 \$ 12 pk</p>	<p>Torsion Unit 42295 \$ 206 ea</p>	<p>End Support Kit 42290 \$ 206 pr</p>

G4 STALK STOMPERS

KITS FOR LEXION

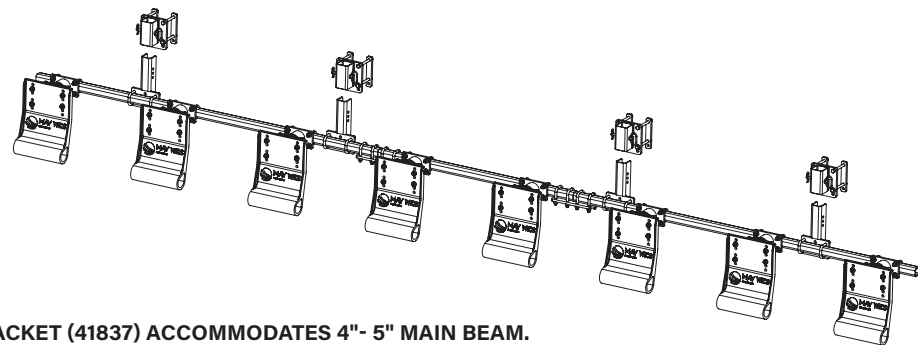

NOTE: HEADER BRACKET (41837) ACCOMMODATES 4"- 5" MAIN BEAM.

TOOLBAR ASSEMBLY KITS

Number of Rows	Kit Part No	Retail Price	2x2 Toolbar	Head Mounting Brackets	Toolbar Splice
----------------	-------------	--------------	-------------	------------------------	----------------

WITH TOOLBAR

NOTE: Toolbar configuration based on 30" rows; kit will accommodate narrower rows.

2-Row	84699	\$ 1803	72" (Qty 2)	Qty 4 ea	N/A
4-Row	84700	\$ 2369	72" (Qty 2)	Qty 4 ea	N/A
6-Row *	84701	\$ 3142	102" (Qty 2)	Qty 4 ea	N/A
8-Row *	84702	\$ 3966	102" (Qty 3)	Qty 4 ea	Qty 2 ea
12-Row *	84703	\$ 5176	102" (Qty 3) + 72" (Qty2)	Qty 4 ea	Qty 4 ea
16-Row *	84704	\$ 6103	102" (Qty 5)	Qty 4 ea	Qty 4 ea

WITHOUT TOOLBAR

The 2x2 toolbar is required but can be purchased locally to reduce shipping cost.

This is standard 2x2 square 3/16" - sidewall tubing available from most fabrication shops or metal supply companies.

2-Row	84705	\$ 1597	N/A	Qty 4 ea	N/A
4-Row	84706	\$ 2112	N/A	Qty 4 ea	N/A
6-Row *	84707	\$ 2962	N/A	Qty 4 ea	N/A
8-Row *	84708	\$ 3657	N/A	Qty 4 ea	Qty 2 ea
12-Row *	84709	\$ 4713	N/A	Qty 4 ea	Qty 2 ea
16-Row *	84710	\$ 5562	N/A	Qty 4 ea	Qty 2 ea

*Due to variation of implement configurations, row coverage under the feederhouse may not be applicable.

Kits are NOT compatible with Claas headers.

REPLACEMENT PARTS FOR LEXION

<p>Single Row Shoe Assembly 43102 \$ 428 ea</p>	<p>12" Shoe 24100 \$ 148 ea</p>	<p>Head Mounting Bracket 41837 \$ 182 ea</p>	<p>Vertical Bracket 41834 \$ 109 ea</p>	<p>2x2 Toolbar 72" 41672 \$ 124 ea 102" 41673 \$ 181 ea</p>
<p>Toolbar Mount Bracket 43101 \$ 125 ea</p>	<p>Torsion Unit 42295 \$ 206 ea</p>	<p>Toolbar Splice 41827 \$ 63 ea</p>	<p>Bent Pin & Clip (2 pack) 42384 \$ 12 pk</p>	

G4 STALK STOMPERS

KITS FOR AGCO: MASSEY / GLEANER / CHALLENGER

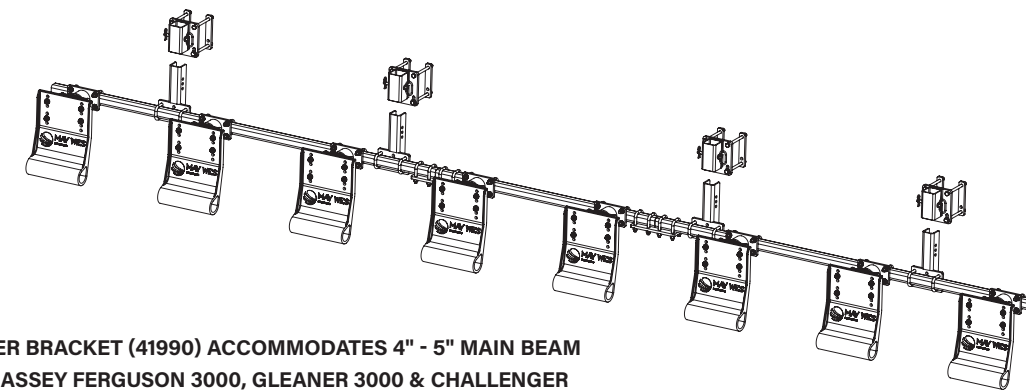

NOTE: HEADER BRACKET (41990) ACCOMMODATES 4" - 5" MAIN BEAM

NOTE: FITS MASSEY FERGUSON 3000, GLEANER 3000 & CHALLENGER

TOOLBAR ASSEMBLY KITS

Number of Rows	Kit Part No	Retail Price	2x2 Toolbar	Head Mounting Brackets	Toolbar Splice
----------------	-------------	--------------	-------------	------------------------	----------------

WITH TOOLBAR

NOTE: Toolbar configuration based on 30" rows; kit will accommodate narrower rows.

2-Row	84711	\$ 1803	72" (Qty 2)	Qty 4 ea	N/A
4-Row	84712	\$ 2395	72" (Qty 2)	Qty 4 ea	N/A
6-Row *	84713	\$ 3142	102" (Qty 2)	Qty 4 ea	N/A
8-Row *	84714	\$ 3966	102" (Qty 3)	Qty 4 ea	Qty 2 ea
12-Row *	84715	\$ 5279	102" (Qty 3) + 72" (Qty2)	Qty 4 ea	Qty 4 ea

WITHOUT TOOLBAR

The 2x2 toolbar is required but can be purchased locally to reduce shipping cost.

This is standard 2x2 square 3/16" - sidewall tubing available from most fabrication shops or metal supply companies.

2-Row	84716	\$ 1597	N/A	Qty 4 ea	N/A
4-Row	84717	\$ 2112	N/A	Qty 4 ea	N/A
6-Row *	84718	\$ 2962	N/A	Qty 4 ea	N/A
8-Row *	84719	\$ 3683	N/A	Qty 4 ea	Qty 2 ea
12-Row *	84720	\$ 4816	N/A	Qty 4 ea	Qty 2 ea

*Due to variation of implement configurations, row coverage under the feederhouse may not be applicable.

REPLACEMENT PARTS FOR AGCO: MASSEY / GLEANER / CHALLENGER

<p>Single Row Shoe Assembly 43102 \$ 428 ea</p>	<p>12" Shoe 24100 \$ 148 ea</p>	<p>Head Mounting Bracket 41990 \$ 182 ea</p>	<p>Vertical Bracket 41834 \$ 109 ea</p>	<p>2x2 Toolbar 72" 41672 \$ 124 ea 102" 41673 \$ 181 ea</p>
<p>Toolbar Mount Bracket 43101 \$ 125 ea</p>	<p>Torsion Unit 42295 \$ 206 ea</p>	<p>Toolbar Splice 41827 \$ 63 ea</p>	<p>Bent Pin & Clip (2 pack) 42384 \$ 12 pk</p>	



G4 STALK STOMPERS

KITS FOR CAPELLO DIAMANT



PART NO	DESCRIPTION	RETAIL PRICE
84819	2 Row Kit	\$ 2241
84824	Kit without Toolbar	\$ 2035
Included Parts		Quantity
2x2 Toolbar - 72"		Qty: 2
Head Mounting Brackets		Qty: 4
Toolbar Splice		N/A



PART NO	DESCRIPTION	RETAIL PRICE
84820	4 Row Kit	\$ 2910
84825	Kit without Toolbar	\$ 2781
Included Parts		Quantity
2x2 Toolbar - 72"		Qty: 2
Head Mounting Brackets		Qty: 4
Toolbar Splice		N/A

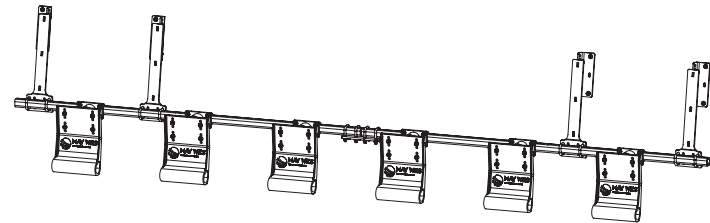

PART NO	DESCRIPTION	RETAIL PRICE
84821	6 Row Kit	\$ 3657
84826	Kit without Toolbar	\$ 3425
Included Parts		Quantity
2x2 Toolbar - 102"		Qty: 2
Head Mounting Brackets		Qty: 4
Toolbar Splice		OPTIONAL



PART NO	DESCRIPTION	RETAIL PRICE
84821	6 Row Kit for 8 Row or Larger Heads	\$ 3657
84826	Kit without Toolbar	\$ 3425
Included Parts		Quantity
2x2 Toolbar - 102"		Qty: 2
Head Mounting Brackets		Qty: 4
Toolbar Splice		N/A

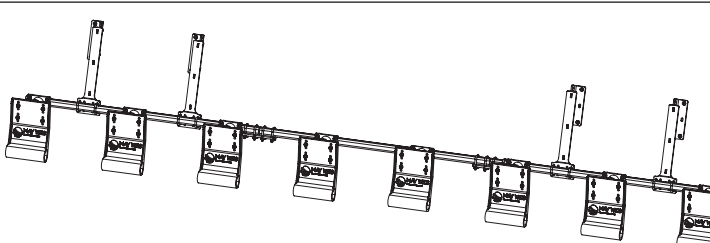

PART NO	DESCRIPTION	RETAIL PRICE
84822	8 Row Kit	\$ 4584
84827	Kit without Toolbar	\$ 4275
Included Parts		Quantity
2x2 Toolbar - 72"		Qty: 1
- 102"		Qty: 2
Head Mounting Brackets		Qty: 4
Toolbar Splice		Qty: 2

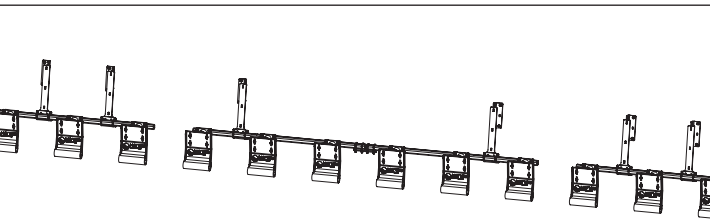

PART NO	DESCRIPTION	RETAIL PRICE
84823	12 Row Kit	\$ 5794
84828	Kit without Toolbar	\$ 5511
Included Parts		Quantity
2x2 Toolbar - 72"		Qty: 2
- 102"		Qty: 2
Head Mounting Brackets		Qty: 6
Toolbar Splice		Qty: 2

Note: 12 Row Kit fits rigid head only.

The 2x2 toolbar is required but can be purchased locally to reduce shipping cost.

This is standard 2x2 square 3/16" - sidewall tubing available from most fabrication shops or metal supply companies.



G4 STALK STOMPERS

REPLACEMENT PARTS FOR CAPELLO DIAMANT

<p>Single Row Shoe Assembly 43102 \$ 428 ea</p>	<p>12" Shoe 24100 \$ 148 ea</p>	<p>2x2 Toolbar - 72" 41672 \$ 124 ea 41673 \$ 181 ea</p>	<p>Header Bracket Assembly 42494 \$ 325 ea</p>
<p>Toolbar Mount Bracket 43101 \$ 125 ea</p>	<p>Bent Pin & Clip (2 pack) 42384 \$ 12 pk</p>	<p>Torsion Unit 42295 \$ 206 ea</p>	<p>Toolbar Splice 41827 \$ 63 ea</p>

GRAIN TANK AUGER TROUGH LINERS

Protect the high-wear areas in your grain tank

FIND THEM ON PAGE 93

MAY WES
Original Poly People
A DIVISION OF PRIDE SOLUTIONS

FOLLOW US ON SOCIAL MEDIA!

WE'D LOVE TO SEE PHOTOS & VIDEOS OF YOUR MAY WES EQUIPMENT IN ACTION!

TAG US IN YOUR POSTS SO WE CAN SHARE THEM!

- Facebook: MayWesManufacturing
- Instagram: maywesmanufacturing
- YouTube: maywesmn
- X: maywesmfg
- TikTok: maywesmanufacturing



G4 STALK STOMPERS

KITS FOR CAPELLO QUASAR

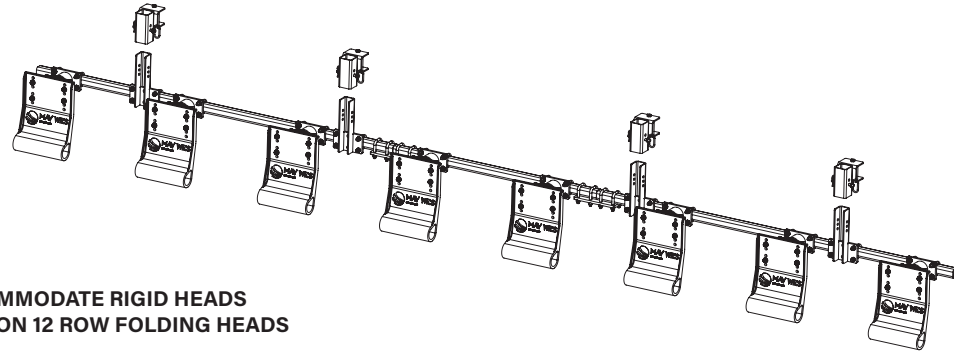

**NOTE: KITS ACCOMMODATE RIGID HEADS
- MAY NOT WORK ON 12 ROW FOLDING HEADS**

TOOLBAR ASSEMBLY KITS

Number of Rows	Kit Part No	Retail Price	2x2 Toolbar	Head Mounting Brackets	Toolbar Splice
----------------	-------------	--------------	-------------	------------------------	----------------

WITH TOOLBAR

NOTE: Toolbar configuration based on 30" rows; kit will accommodate narrower rows.

2-Row	84739	\$ 1751	72" (Qty 2)	Qty 4 ea	N/A
4-Row	84740	\$ 2369	72" (Qty 2)	Qty 4 ea	N/A
6-Row *	84741	\$ 3116	102" (Qty 2)	Qty 4 ea	N/A
8-Row *	84742	\$ 3966	102" (Qty 3)	Qty 4 ea	Qty 2 ea
12-Row *	84743	\$ 5305	102" (Qty 2) + 72" (Qty 2)	Qty 4 ea	Qty 4 ea
16-Row *	84744	\$ 6232	102" (Qty 5)	Qty 4 ea	Qty 4 ea

WITHOUT TOOLBAR

The 2x2 toolbar is required but can be purchased locally to reduce shipping cost.

This is standard 2x2 square 3/16" - sidewall tubing available from most fabrication shops or metal supply companies.

2-Row	84745	\$ 1571	N/A	Qty 4 ea	N/A
4-Row	84746	\$ 2112	N/A	Qty 4 ea	N/A
6-Row *	84747	\$ 2962	N/A	Qty 4 ea	N/A
8-Row *	84748	\$ 3657	N/A	Qty 4 ea	Qty 2 ea
12-Row *	84749	\$ 4816	N/A	Qty 4 ea	Qty 2 ea
16-Row *	84750	\$ 5588	N/A	Qty 4 ea	Qty 2 ea

*Due to variation of implement configurations, row coverage under the feederhouse may not be applicable.

REPLACEMENT PARTS FOR CAPELLO QUASAR

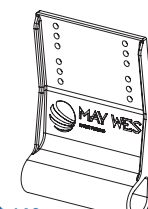
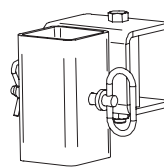
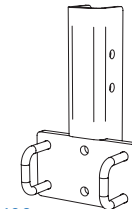
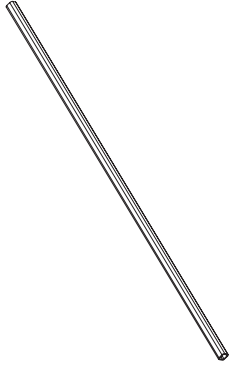
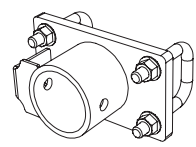
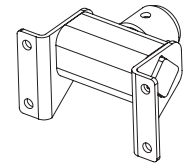
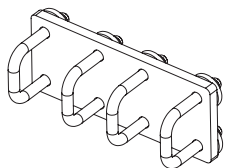
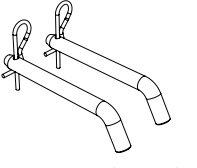
 Single Row Shoe Assembly 43102 \$ 428 ea	 12" Shoe 24100 \$ 148 ea	 Head Mounting Bracket 42006 \$ 182 ea	 Vertical Bracket 41834 \$ 109 ea	 2x2 Toolbar 72" 41672 \$ 124 ea 102" 41673 \$ 181 ea
 Toolbar Mount Bracket 43101 \$ 125 ea	 Torsion Unit 42295 \$ 206 ea	 Toolbar Splice 41827 \$ 63 ea	 Bent Pin & Clip (2 pack) 42384 \$ 12 pk	



G4 STALK STOMPERS

KITS FOR FANTINI

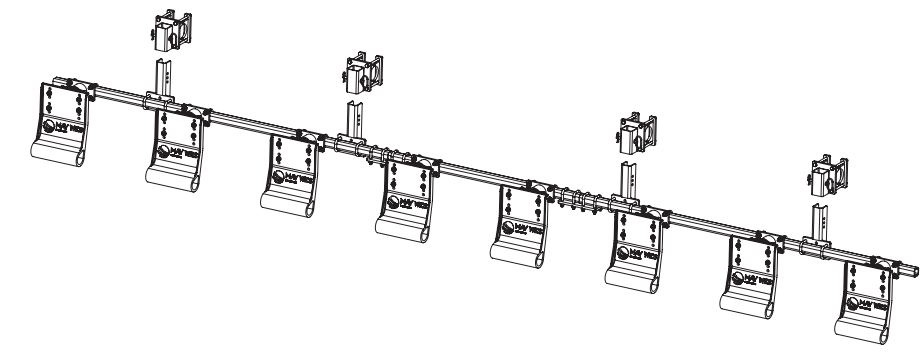

TOOLBAR ASSEMBLY KITS

Number of Rows	Kit Part No	Retail Price	2x2 Toolbar	Head Mounting Brackets	Toolbar Splice
----------------	-------------	--------------	-------------	------------------------	----------------

WITH TOOLBAR

NOTE: Toolbar configuration based on 30" rows; kit will accommodate narrower rows.

2-Row	84729	\$ 1803	72" (Qty 2)	Qty 4 ea	N/A
4-Row	84730	\$ 2369	72" (Qty 2)	Qty 4 ea	N/A
6-Row *	84731	\$ 3142	102" (Qty 2)	Qty 4 ea	N/A
8-Row *	84732	\$ 3966	102" (Qty 3)	Qty 4 ea	Qty 2 ea
12-Row *	84733	\$ 5176	102" (Qty 3) + 72" (Qty 2)	Qty 4 ea	Qty 4 ea

WITHOUT TOOLBAR



The 2x2 toolbar is required but can be purchased locally to reduce shipping cost.

This is standard 2x2 square 3/16" - sidewall tubing available from most fabrication shops or metal supply companies.

2-Row	84734	\$ 1597	N/A	Qty 4 ea	N/A
4-Row	84735	\$ 2112	N/A	Qty 4 ea	N/A
6-Row *	84736	\$ 2962	N/A	Qty 4 ea	N/A
8-Row *	84737	\$ 3683	N/A	Qty 4 ea	Qty 2 ea
12-Row *	84738	\$ 4713	N/A	Qty 4 ea	Qty 2 ea

*Due to variation of implement configurations, row coverage under the feederhouse may not be applicable.



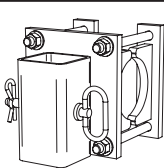
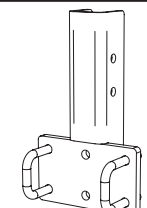
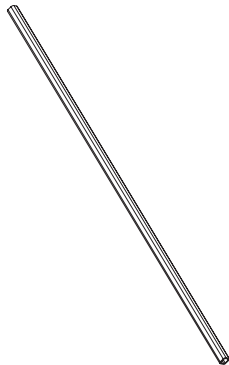
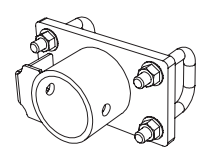
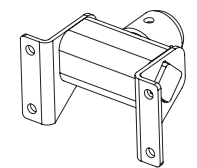
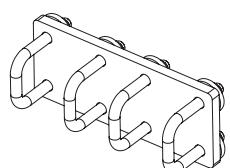
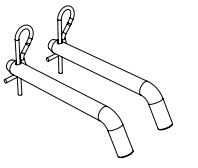

REPLACEMENT PARTS FOR FANTINI

 Single Row Shoe Assembly 43102 \$ 428 ea	 12" Shoe 24100 \$ 148 ea	 Head Mounting Bracket 41787 \$ 268 ea	 Vertical Bracket 41834 \$ 109 ea	 2x2 Toolbar 72" 41672 \$ 124 ea 102" 41673 \$ 181 ea
 Toolbar Mount Bracket 43101 \$ 125 ea	 Torsion Unit 42295 \$ 206 ea	 Toolbar Splice 41827 \$ 63 ea	 Bent Pin & Clip (2 pack) 42384 \$ 12 pk	

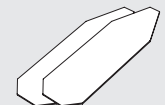
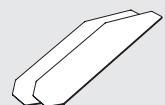
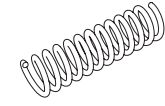
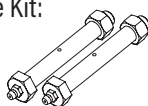
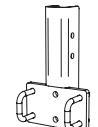
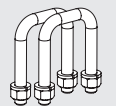
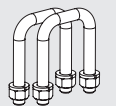
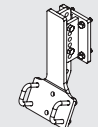
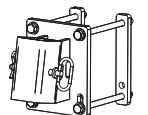

Check out our website - WWW.MAYWES.COM for more information, installation instructions and our full lineup of poly products.

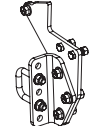
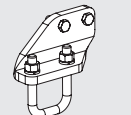
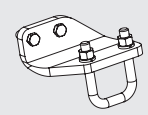
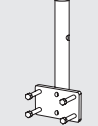
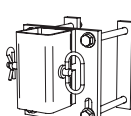
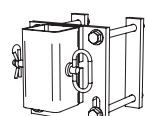
QUICK DISCONNECT 2 STALK STOMPERS

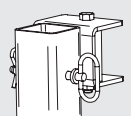
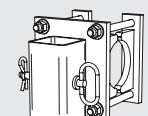
ASSEMBLY / REPLACEMENT COMPONENTS			
QD2 Stalk Stomper Assembly without Mount Bracket - 9" Shoe 43003 \$ 361 ea 	Poly Shoe Cover with Hardware 9" 40012 \$ 74 pr 14" 41713 \$ 100 pr 	Offset Poly Shoe Cover w/ Hardware 41948 \$ 74 pr 	
Stalk Stomper Spring 01040 \$ 23 ea 	QD2 Stalk Stomper Hardware Kit: Includes chains, nuts, bolts & greasable bolts 41965 \$ 21 ea 	Vertical Bracket 41834 \$ 109 ea 	
U Bolt - (4 pack) 4x4 Mount 42293 \$ 31 pk 	U Bolt - (2 pack) 2x2 Mount 41993 \$ 16 pk 	Drago GT Header Bracket 42282 \$ 232 ea 	
John Deere 600/700 Header Bracket 41848 \$ 182 ea 	Drago Series I & II Header Bracket 41788 \$ 160 ea 	Geringhoff Patriot/Northstar/Rota Disc Header Bracket 42375 \$ 109 ea 	
Geringhoff Horizon Left Header Bracket 42135 \$ 78 ea 	Geringhoff Horizon Right Header Bracket 42134 \$ 78 ea 	Harvestec Header Bracket 41957 \$ 129 ea 	
AGCO: Massey/Gleaner/Challenger Header Bracket 41990 \$ 182 ea 	Lexion Header Bracket 41837 \$ 182 ea 	<div style="text-align: center;"> <p>ORDER ONLINE 24/7</p> <p>Scan the QR code with your phone to visit maywes.com.</p>  </div>	
Capello Header Bracket 42006 \$ 182 ea 	Fantini Header Bracket 41787 \$ 268 ea 		

POLY CUTTING EDGE

STOP SCRATCHING YOUR ASPHALT!

Snow Plows, Snow Pushers & Buckets

Slick & Durable UHMW Poly Protects Pavement from Plow Damage

Horizontal Application - Beveled on both sides. Optional counterbored holes.



ORDER ONLINE WITH OUR NEW CONFIGURATOR TOOL AT MAYWES.COM

Vertical Application - Unbeveled. Optional drilled holes.



"We decided to make the switch from metal cutting edges to the May Wes Poly Cutting Edge in an effort to prevent scuffing our new sidewalks. May Wes helped us figure out the proper Poly Cutting Edge size requirements to fit our particular snow blowers and plow blades. We like how the poly material flexes when the blade hits uneven sidewalks, preventing the shock on the equipment and chipping the concrete. We are satisfied with the service from May Wes and the quick product shipment."

Mike Drew, Park Superintendent
City of Glencoe, MN

Featured by Fast Ag Montana, Larson Farms, Stanley the Dirt Monkey and Finstad Skidloader Service



Made in the U.S.A.

More information on pages 143 - 144

4 Tractor Stompers

STUBBLE DAMAGE PROTECTION
STALK STOMPERS FOR TRACTORS



WORKS OFF OF EXISTING TRACTOR HYDRAULICS

- Use an existing open remote to control the Stalk Stompers, allowing independent control and float operation.
- Plumb a Tee into existing implement lines so that the Stompers raise and lower automatically with your implement.

KIT IS BUILT AROUND A STANDARD 4" X 4" TOOLBAR

You have the option to supply your own 4" x 4" toolbar or you can purchase through May Wes. (Oversize shipping charges will apply.)

NO DRILLING OR WELDING REQUIRED!

Designed for quick assembly and doesn't typically require welding or drilling.

ROW-CROP CONFIGURATION

Great for knocking down stalks when planting in no-till applications.

Stalk Stompers Promote Residue Decomposition!



TRACTOR STALK STOMPER KITS WITH MOUNTS

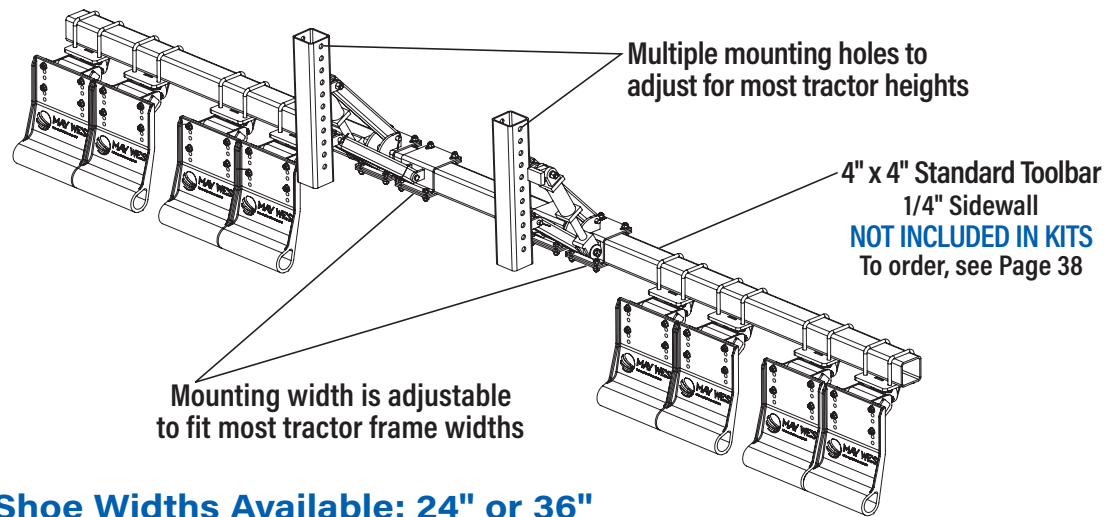

Multiple Shoe Widths Available: 24" or 36"

• Toolbar is available for purchase separately.
(See page 38)

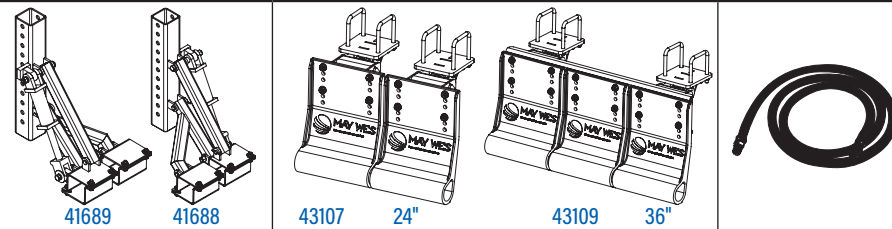

KIT PART NO	RETAIL PRICE	MOUNT KIT	LIFT ARM ASSEMBLIES	SHOE CONFIGURATION	HYDRAULIC KIT
FOR CASE IH MAGNUM 235 / 250 / 260 / 280 / 290 / 310 / 315 / 340 / 370 / 380					
83765	\$ 5974	42013	Qty 1 ea	24" - Qty 2	25 ft
83766	\$ 6932		Qty 1 ea	24" - Qty 4	25 ft
FOR CASE IH QUADTRAC 450 / 500 / 540 / 550 / 580 / 600 / 620 - 2012 & NEWER					
83767	\$ 6464	41730	Qty 1 ea	36" - Qty 2	35 ft
FOR CASE IH STEIGER 500 / 540 / 550 / 580 / 600 / 620 - 2012 & NEWER					
83768	\$ 7880	41731	Qty 1 ea	36" - Qty 4	35 ft
FOR CASE IH STEIGER 350 / 370 / 400 / 420 / 450 / 470 - 2012 & NEWER WITHOUT FRONT BALLAST					
83769	\$ 7880	41969	Qty 1 ea	36" - Qty 4	35 ft
FOR CASE IH STEIGER 350 / 370 / 400 / 420 / 450 / 470 - 2012 & NEWER WITH FRONT BALLAST (NOT COMPATIBLE WITH FRONT WEIGHT CARRIER)					
83770	\$ 6500	42287	Qty 1 ea	36" - Qty 2	35 ft
83771	\$ 7839		Qty 1 ea	36" - Qty 4	35 ft
FOR CASE IH STEIGER / QUADTRAC 485 / 535 - 2011 & OLDER					
83779	\$ 7004	41687	Qty 1 ea	24" - Qty 4	35 ft
83772	\$ 6464		Qty 1 ea	36" - Qty 2	35 ft
83773	\$ 7839		Qty 1 ea	36" - Qty 4	35 ft
FOR NEW HOLLAND T9.615 / T9.670 WITH SMARTTRAX					
83774	\$ 6541	41744	Qty 1 ea	36" - Qty 2	35 ft
FOR NEW HOLLAND T9.600 / T9.615 / T9.645 / T9.670 / T9.700					
83775	\$ 7880	41731	Qty 1 ea	36" - Qty 4	35 ft
FOR NEW HOLLAND T9.390 / T9.435 / T9.450 / T9.480 / T9.505 / T9.530 / T9.560 / T9.565 WITHOUT FRONT BALLAST					
83776	\$ 7880	41969	Qty 1 ea	36" - Qty 4	35 ft
FOR NEW HOLLAND T9.390 / T9.435 / T9.450 / T9.480 / T9.505 / T9.530 / T9.560 / T9.565 WITH FRONT BALLAST (NOT COMPATIBLE WITH FRONT WEIGHT CARRIER)					
83777	\$ 6464	42287	Qty 1 ea	36" - Qty 2	35 ft
83778	\$ 7839		Qty 1 ea	36" - Qty 4	35 ft

TRACTOR STALK STOMPER KITS WITH MOUNTS

KIT PART NO	RETAIL PRICE	MOUNT KIT	LIFT ARM ASSEMBLIES	SHOE CONFIGURATION	HYDRAULIC KIT
FOR JOHN DEERE 9RX SERIES - 2016 & NEWER					
83712	\$ 6335	42383	Qty 1 ea	24" - Qty 2	35 ft
83711	\$ 6670		Qty 1 ea	36" - Qty 2	35 ft
FOR JOHN DEERE 9R SERIES - 2015 & NEWER					
83713	\$ 8292	42322	Qty 1 ea	36" - Qty 4	35 ft
FOR JOHN DEERE 9R SERIES 2012 - 2014					
83714	\$ 7545	41994	Qty 1 ea	24" - Qty 4	35 ft
83736	\$ 8292		Qty 1 ea	36" - Qty 4	35 ft
FOR JOHN DEERE 9RT SERIES 2012 - 2014					
83737	\$ 6644	42320	Qty 1 ea	36" - Qty 2	35 ft
FOR JOHN DEERE 9030 SERIES - ALL MODELS (NOT COMPATIBLE WITH FRONT WEIGHT BRACKET)					
83738	\$ 7545	41697	Qty 1 ea	24" - Qty 4	35 ft
83739	\$ 8240		Qty 1 ea	36" - Qty 4	35 ft
FOR JOHN DEERE 8000 / 8010 / 8020 / 8030 / 8R SERIES - ALL MODELS (INCLUDING TRACK MODELS EXCEPT 8RX)					
83744	\$ 6438	41728	Qty 1 ea	24" - Qty 2	25 ft
83745	\$ 8034		Qty 1 ea	24" - Qty 4	25 ft
83746	\$ 6747		Qty 1 ea	36" - Qty 2	25 ft
FOR CHALLENGER 700 / 700B / 700C / 700D SERIES - ALL MODELS					
83748	\$ 5897	41684	Qty 1 ea	24" - Qty 2	25 ft
83750	\$ 6283		Qty 1 ea	36" - Qty 2	25 ft
FOR CHALLENGER 700E SERIES ALL MODELS					
83751	\$ 6283	42264	Qty 1 ea	24" - Qty 2	25 ft
83879	\$ 6464		Qty 1 ea	36" - Qty 2	25 ft
FOR CHALLENGER 800 SERIES ALL MODELS					
83880	\$ 5949	41707	Qty 1 ea	24" - Qty 2	25 ft
83881	\$ 6464		Qty 1 ea	36" - Qty 2	25 ft
FOR UNIVERSAL KITS (KITS DO NOT INCLUDE TRACTOR SPECIFIC MOUNT BRACKET OR TOOLBAR)					
83889	\$ 5408	N/A	Qty 1 ea	24" - Qty 2	35 ft
83890	\$ 6464		Qty 1 ea	24" - Qty 4	35 ft
83891	\$ 5949		Qty 1 ea	36" - Qty 2	35 ft
83892	\$ 7339		Qty 1 ea	36" - Qty 4	35 ft

4" x 4" Toolbar not included in kits. To order separately, see Page 38.

REPLACEMENT PARTS FOR TRACTOR STALK STOMPERS

<p>12" Shoe 24100 \$ 148 ea</p>	<p>12" Shoe Assembly 43105 \$ 577 ea</p>	<p>24" Shoe Assembly 43107 \$ 1056 ea</p>	<p>36" Shoe Assembly 43109 \$ 1329 ea</p>
<p>Torsion Unit 42295 \$ 206 ea</p>	<p>Toolbar Mount Bracket 43104 \$ 222 ea</p>	<p>36" Shoe Connector 22863 \$ 160 ea</p>	<p>24" - 36" Offset Kit 42767 \$ 521 ea</p>



TRACTOR STALK STOMPER COMPONENTS

TRACTOR MOUNT KITS

FOR Case IH MAGNUM 235/260/280/
290/310/315/340/370/380

42013 \$ 1175 ea

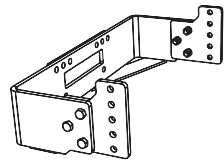

FOR Case IH QUADTRAC 450/500/540/
550/580/ 600/620
(2012 & Newer)

41730 \$ 1314 ea

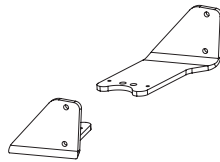

FOR Case IH STEIGER 500/540/550/
580/600/620
(2012 & Newer)

41731 \$ 1051 ea

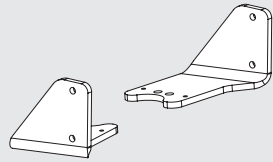

FOR Case IH STEIGER 300/370/400/420/450/470
w/o Front Ballast
(2012 & Newer)

41969 \$ 1010 ea

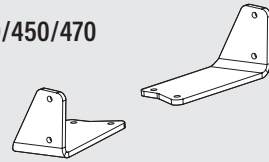

FOR Case IH STEIGER/QUADTRAC 485/535
(2011 & Older)

41687 \$ 603 ea

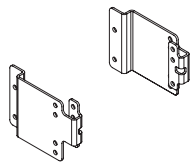

FOR Case IH Steiger 350/370/400/420/450 /470
with Front Ballast (2012 and Newer)
(not compatible with front weight carrier)

42287 \$ 876 ea

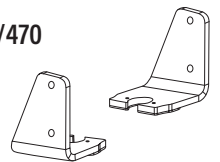

FOR New Holland T9.615/T9.670
with SmartTrax

41744 \$ 1051 ea

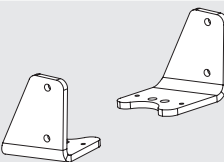

FOR New Holland T9.600/
T9.615/T9.645/T9.670/T9.700

41731 \$ 1051 ea

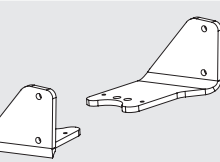

FOR New Holland T9.390/T9.435/
T9.450/T9.480/T9.505/T9.530/
T9.560/T9.565 w/o Front Ballast

41969 \$ 1010 ea

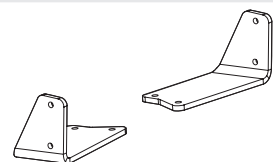

FOR New Holland T9.390/ T9.435/T9.450/
T9.505/T9.530/T9.560/T9.565
with Front Ballast
(not compatible with front weight carrier)

42287 \$ 876 ea

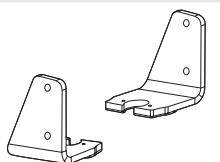

FOR John Deere 9RT Series
(2012-2014)

42320 \$ 1051 ea

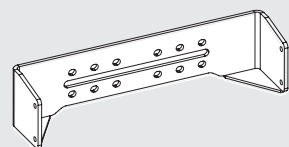

FOR John Deere 9030 Series
(not compatible with front weight carrier)

41697 \$ 665 ea

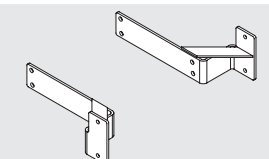

FOR John Deere 8000/8010/
8020/8030/8R/8RT Series

41728 \$ 1072 ea

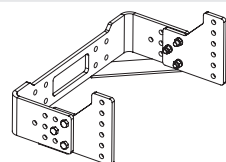

FOR John Deere 9RX Series
(2016 & Newer)

42383 \$ 1051 ea

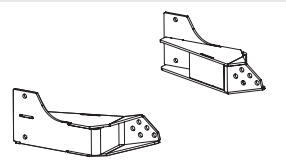

FOR John Deere 9R Series
(2015 & Newer)

42322 \$ 706 ea

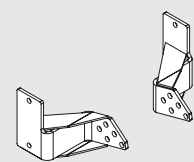

FOR John Deere 9R Series
(2012-2014)

41994 \$ 737 ea

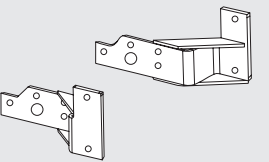

FOR Challenger 700/700B/
700C/700D Series

41684 \$ 698 ea

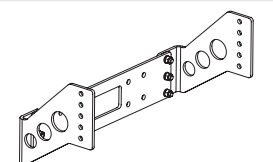

FOR Challenger 700E Series All Models

42264 \$ 1051 ea

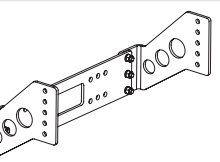

FOR Challenger 800 Series

41707 \$ 799 ea

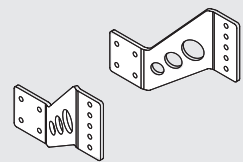

ORDER ONLINE 24/7

Scan the QR code
with your phone to
visit maywes.com.



TRACTOR STALK STOMPER COMPONENTS

ASSEMBLY COMPONENTS

Right Lift Arm Assembly
(Includes cylinder)

41688 \$ 1442 ea

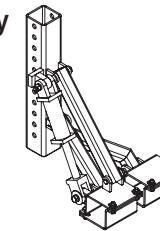

4x4 12-Foot Toolbar
22263 \$ 773 ea

Not included in kits.

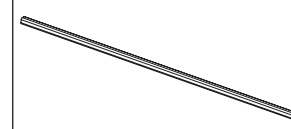

Hydraulic Hose Kit

41797 25 ft. \$ 716 ea

41798 30 ft. \$ 768 ea

41799 35 ft. \$ 840 ea



Left Lift Arm Assembly
(Includes cylinder)

41689 \$ 1442 ea

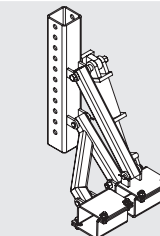

The 4x4 toolbar is required
but can be purchased
locally to reduce shipping
cost. This is standard 4x4
square 1/4" - sidewall
tubing available from most
fabrication shops or metal
supply companies.

ORDER ONLINE 24/7

Scan the QR code
with your phone to
visit maywes.com.

SCAN ME



REPLACEMENT PARTS

Poly Shoe Replacement
Cover w/ Rivets 14"

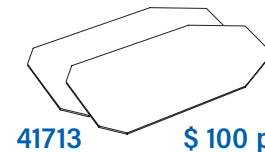

41713 \$ 100 pr

Poly Shoe Replacement
Cover w/Rivets 24"

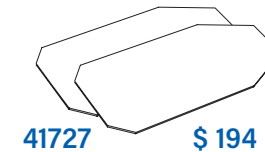

41727 \$ 194 pr

Poly Shoe Replacement
Cover w/Rivets 32"

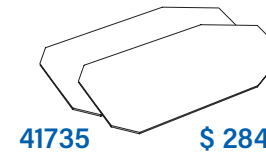

41735 \$ 284 pr

Poly Shoe Replacement
Cover w/Rivets 38"

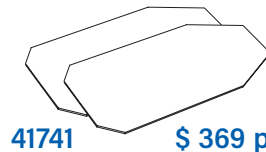

41741 \$ 369 pr

Right
Vertical
Mount

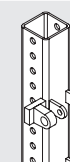

41690 \$ 340 ea

Right Hinge Bracket

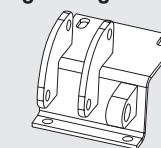

41693 \$ 196 ea

Upper Connecting Arm

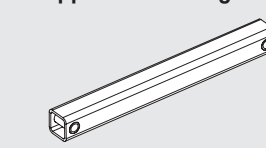

41696 \$ 109 ea

Stomper Spring

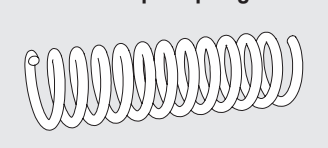

01040 \$ 23 ea

Left
Vertical
Mount

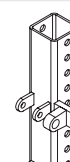

41691 \$ 340 ea

Left Hinge Bracket

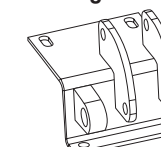

41695 \$ 196 ea

Lower Connecting Arm

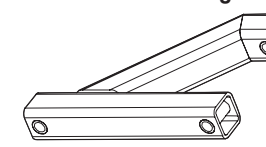

41692 \$ 256 ea

Hydraulic Cylinder

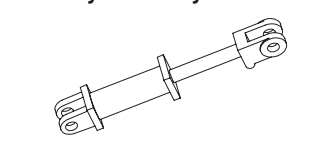

00961 \$ 258 ea

Hinge Support Bracket

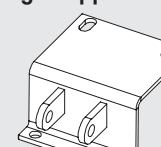

41694 \$ 98 ea

U Bolt - 4x4 Mount
(2 pack)

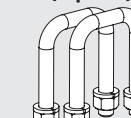

42244 \$ 22.50 pk

Hardware Kit
Includes chains, nuts, bolts & greasable bolts

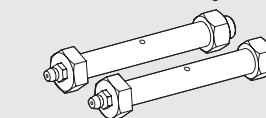

41965 \$ 21 ea

Hinge Clamp

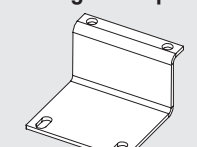

22264 \$ 52 ea

Planter Stompers

For John Deere 1770 NT
and Case IH 1250 Early Riser

page 133



DRAW BAR SAVERS

REDUCE FRICTION AND SAVE COMPONENT WEAR

UHMW Draw Bar Savers for your draw bars and hitches have slick properties for durability and wear resistance. Stacking may be used to achieve the desired thickness for your application.

4" OUTSIDE DIAMETER

DESCRIPTION	1" I.D. PART NO	1 1/4" I.D. PART NO	1 1/2" I.D. PART NO	1 3/4" I.D. PART NO	2" I.D. PART NO	RETAIL PRICE
3/8" Thick	42247	42248	42249	42250	42251	\$ 7.00 ea
1/2" Thick	42015	42018	42021	42024	42027	\$ 8.00 ea
3/4" Thick	42016	42019	42022	42025	42028	\$ 10.00 ea
1" Thick	42017	42020	42023	42026	42029	\$ 13.00 ea

6" OUTSIDE DIAMETER

DESCRIPTION	2" I.D. PART NO	2 1/4" I.D. PART NO	2 1/2" I.D. PART NO	2 3/4" I.D. PART NO	3" I.D. PART NO	RETAIL PRICE
3/8" Thick	42252	42253	42254	42255	42256	\$ 10.00 ea
1/2" Thick	42030	42033	42036	42039	42042	\$ 13.00 ea
3/4" Thick	42031	42034	42037	42040	42043	\$ 17.00 ea
1" Thick	42032	42035	42038	42041	42044	\$ 21.00 ea

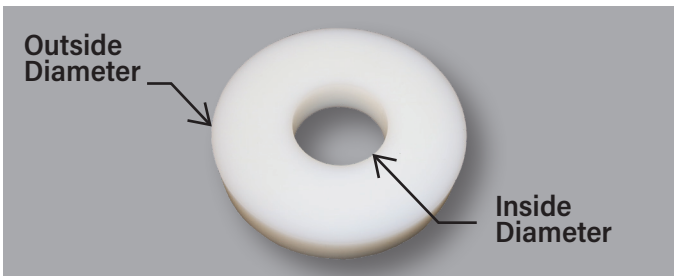

As Featured by the Minnesota Millennial Farmer
[youtube.com/MNMillennialFarmer](https://www.youtube.com/MNMillennialFarmer)



TRACTOR DRAWBAR CATEGORIES & PIN DIAMETER

TRACTOR DRAW BAR CATEGORY	MAX TRACTOR PTO POWER RATING		MINIMUM PIN DIAMETER	
	HP	KW	IN.	MM
0	38	28	1"	18
1	64	48	1 1/4"	30
2	154	115	1 1/4"	30
3	248	185	1 1/2"	38
4	402	300	2"	50
5	671	500	2 3/4"	70

CUSTOMER APPROVED...

"We used a May Wes Draw Bar Saver in a daily high-wear application and after two months we checked and the draw bar saver hardly showed any wear. We are very impressed with this product and promote it with our customers."

- Ron, Franzen Sales & Service

REAR FENDER EXTENSIONS FOR JOHN DEERE TRACTORS

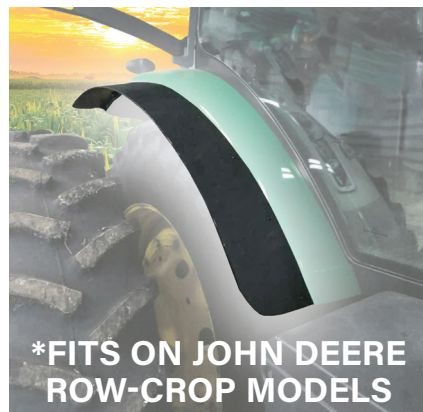

***FITS ON JOHN DEERE ROW-CROP MODELS**

Each set includes one left and one right fender extension plus mounting instructions and hardware.

(Drilling required)

PRACTICAL & EFFICIENT!

- Strong, Heavy Duty Construction
- Contour Fitting Design
- UV Stabilized
- Easy Installation
- Cost Efficient

Don't see your tractor listed? Visit maywes.com for more options.

* Fender Extensions will not wrap around the back of the tractor cab.

PART NO	DESCRIPTION	RETAIL PRICE
83824	Series 3 *- Fits: 8225R, 8235R, 8245R, 8260R, 8270R, 8285R, 8295R, 8310R, 8320R, 8335R, 8345R, 8360R, 8370R and 8400R	\$ 260 kit
83823	Series 2 *- Fits: 7820, 7920, 7830, 7930, 8120, 8130, 8220, 8230, 8320, 8330, 8420, 8430, 8520, 8530	\$ 260 kit
83822	Series 1 - Fits: 7700, 7800, 7710, 7810, 8100, 8200, 8300, 8400, 8110, 8210, 8310, 8410	\$ 200 kit

*Drilling Required. Each Fender is 7 3/4" long (extends to full length of fender).

POLY PICKUP BANDS

A PRACTICAL REPLACEMENT FOR OEM METAL PICKUP BANDS

EXPANDED LINEUP



As Featured by the Minnesota Millennial Farmer

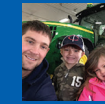

Scan the code with your phone to watch on YouTube.

SCAN ME



Poly Pickup Bands are 1/2" thick and have an additional 1/4" thick reinforced support ring on the inside to strengthen and maintain their shape along with making them impact resistant.



FOR CASE IH SQUARE BALER - Black

MODEL	OEM	HEAD SIZE	QTY REQ	PART NO	RETAIL PRICE
LB324, LB333, LB334, LB424, LB433, LB434, LBX322, LBX331, LBX332, LBX421, LBX422 (with Standard and Packer Cutter Head)	84468627 84607815 84801631 84214800 84274387	-	-	83483	\$ 22.50 ea
LB324, LB333, LB334, LB424, LB433, LB434, LBX322, LBX331, LBX332, LBX421, LBX422 (with Roto Cutter Head)	84607781 84274384	-	-	83484	\$ 22.50 ea
8550, 8570, 8575, 8585	700108607	-	-	83480	\$ 29.95 ea
SB521, SB531, SB541, SB551, SBX520, SBX530, SBX540, SBX550	86635483	-	-	83676	\$ 29.95 ea

FOR CASE IH ROUND BALER - Black

MODEL	OEM	HEAD SIZE	QTY REQ	PART NO	RETAIL PRICE
RBX441	86619049	-	17	83589	\$ 29.95 ea
RBX442	86619049	-	11	83589	\$ 29.95 ea
RBX443	86619049	-	11	83589	\$ 29.95 ea
RBX443	86637150	-	11	83590	\$ 29.95 ea
RBX451	86618417	1.5m	23	83704	\$ 29.95 ea
RBX452	86618417	1.5m	23	83704	\$ 29.95 ea
RBX452	86643381	1.8m	27	83485	\$ 29.95 ea
RBX452	86643381	2.0m	31	83485	\$ 29.95 ea
RBX453	86618417	1.5m	23	83704	\$ 29.95 ea
RBX453	86618417	1.8m	27	83704	\$ 29.95 ea
RBX453	86643381	2.0m	31	83485	\$ 29.95 ea
RBX461	86618417	1.5m	23	83704	\$ 29.95 ea
RBX462	86618417	1.5m	23	83704	\$ 29.95 ea
RBX462	86643381	1.8m	27	83485	\$ 29.95 ea
RBX462	86643381	2.0m	31	83485	\$ 29.95 ea
RBX463	86618417	1.5m	23	83704	\$ 29.95 ea
RBX463	86643381	1.8m	27	83485	\$ 29.95 ea
RBX463	86643381	2.0m	31	83485	\$ 29.95 ea
RBX552	87041202	Standard	23	83591	\$ 29.95 ea
RBX552	86643381	2.0m	Outer 10	83485	\$ 29.95 ea

All Poly Pickup Bands come complete with hardware for easy installation.



POLY PICKUP BANDS

FOR CASE IH ROUND BALER - Black					
MODEL	OEM	HEAD SIZE	QTY REQ	PART NO	RETAIL PRICE
-	87055363	-	Middle 21	83486	\$ 29.95 ea
RBX553	87041202	Standard	23	83591	\$ 29.95 ea
RBX561	87041202	Standard	23	83591	\$ 29.95 ea
RBX562	87041202	Standard	23	83591	\$ 29.95 ea
RBX562	86643381	2.0m	Outer 10	83485	\$ 29.95 ea
-	87055363	-	Middle 21	83486	\$ 29.95 ea
RBX563	87041202	Standard	23	83591	\$ 29.95 ea
RBX563	86643381	2.0m	Outer 10	83485	\$ 29.95 ea
-	87055363	-	Middle 21	83486	\$ 29.95 ea
RB454	86618417	1.5m	23	83704	\$ 29.95 ea
RB454	86643381	1.8m	27	83485	\$ 29.95 ea
RB454	86643381	2.0m	31	83485	\$ 29.95 ea
RB455	84329282	1.8m	27	83817	\$ 29.95 ea
RB455	84329282	2.0m	31	83817	\$ 29.95 ea
RB464	86618417	-	23	83704	\$ 29.95 ea
RB464	86643381	1.8m	27	83485	\$ 29.95 ea
RB464	86643381	2.0m	31	83485	\$ 29.95 ea
RB465	84329282	1.8m	27	83817	\$ 29.95 ea
RB465	84329282	2.0m	31	83817	\$ 29.95 ea
RB554	87041202	Standard	23	83591	\$ 29.95 ea
RB564	86643381	Standard	23	83485	\$ 29.95 ea
RB564	86643381	2.0m	Outer 10	83485	\$ 29.95 ea
-	87055363	-	Middle 21	83486	\$ 29.95 ea
RB565	84370744	1.5m	23	83650	\$ 29.95 ea
RB565	84310057	2.0m	31	83651	\$ 29.95 ea
RB444	86619049	Standard	11	83589	\$ 29.95 ea
8435, RS451, RS551, RS561, RS561A	700132112	-	-	83705	\$ 29.95 ea

FOR NEW HOLLAND SQUARE BALER WITH STANDARD & PACKER CUTTER HEAD - Yellow					
MODEL	OEM	HEAD SIZE	QTY REQ	PART NO	RETAIL PRICE
590, 595, BB940, BB960, BB9050, BB9060, BB9070, BB9080, 230, 330, 340	84801630 89837845 85005357 84214799 84274388	-	-	83481	\$ 22.50 ea

FOR NEW HOLLAND SQUARE BALER WITH ROTO CUTTER HEAD - Yellow					
MODEL	OEM	HEAD SIZE	QTY REQ	PART NO	RETAIL PRICE
590, 595, BB940, BB960, BB9050, BB9060, BB9070, BB9080, 230, 330, 340	84074345 84214794 84274385	-	-	83482	\$ 22.50 ea
276, 311, 315, 316, 320, 326, 565, 568, 570, 575, 580, BC5050, BC5060, BC5070, BC5080	86635482 184550	-	-	83677	\$ 29.95 ea
585	-	-	-	83489	\$ 29.95 ea

FOR NEW HOLLAND ROUND BALER - Yellow					
MODEL	OEM	HEAD SIZE	QTY REQ	PART NO	RETAIL PRICE
630	86619048	Standard	17	83586	\$ 29.95 ea
634	86619048	Standard	11	83586	\$ 29.95 ea
638	86619048	Standard	11	83586	\$ 29.95 ea
640	86618414	Wide	23	83703	\$ 29.95 ea
640	86619048	Standard	23	83586	\$ 29.95 ea
644	86618414	Wide	23	83703	\$ 29.95 ea
644	86637149	Standard	17	83587	\$ 29.95 ea
648	86618414	Wide	23	83703	\$ 29.95 ea
648	86637149	Standard	17	83587	\$ 29.95 ea
650	86618414	Wide	23	83703	\$ 29.95 ea
650	86619048	Standard	23	83586	\$ 29.95 ea
654	86618414	Wide	23	83703	\$ 29.95 ea
654	86637149	Standard	17	83587	\$ 29.95 ea



POLY PICKUP BANDS



FOR NEW HOLLAND ROUND BALER - Yellow					
MODEL	OEM	HEAD SIZE	QTY REQ	PART NO	RETAIL PRICE
658	86618414	Wide	23	83703	\$ 29.95 ea
658	86637149	Standard	17	83587	\$ 29.95 ea
660	86619048	Standard	23	83586	\$ 29.95 ea
664	86637149	Standard	23	83587	\$ 29.95 ea
678	86637149	Standard	23	83587	\$ 29.95 ea
688	86637149	Standard	23	83587	\$ 29.95 ea
BR7050	86619048	Standard	17	83586	\$ 29.95 ea
BR7060	86619048	Standard	17	83586	\$ 29.95 ea
BR7060	86618414	1.5m Wide	23	83703	\$ 29.95 ea
BR7060	86643380	1.8m	Outer 10	83487	\$ 29.95 ea
BR7060	87055364	-	Middle 21	83488	\$ 29.95 ea
BR7060	86643380	2.0m	31	83487	\$ 29.95 ea
BR7070	86618414	1.5m Wide	23	83703	\$ 29.95 ea
BR7070	86643380	1.8m	Outer 10	83487	\$ 29.95 ea
BR7070	87055364	-	Middle 21	83488	\$ 29.95 ea
BR7070	86643380	2.0m	31	83487	\$ 29.95 ea
BR7080	87041203	Standard	23	83588	\$ 29.95 ea
BR7090	87041203	Standard	23	83588	\$ 29.95 ea
BR7090	86643380	2.0m x.s.	Outer 10	83487	\$ 29.95 ea
BR7090	87055364	-	Middle 21	83488	\$ 29.95 ea
BR730	86619048	Standard	17	83586	\$ 29.95 ea
BR730A	86637149	Standard	17	83587	\$ 29.95 ea
BR730A	86619048	Standard	17	83586	\$ 29.95 ea
BR740	86512793	Standard	17	83587	\$ 29.95 ea
BR740	86618414	1.5m Wide	23	83703	\$ 29.95 ea
BR740	86643380	1.8m x.s.	Outer 10	83487	\$ 29.95 ea
BR740	87055364	-	Middle 17	83488	\$ 29.95 ea
BR740	86643380	2.0m	31	83487	\$ 29.95 ea
BR740A	86512793	Standard	17	83587	\$ 29.95 ea
BR740A	86618414	1.5m Wide	23	83703	\$ 29.95 ea
BR740A	86643380	1.8m x.s.	Outer 10	83487	\$ 29.95 ea
BR740A	87055364	-	Middle 17	83488	\$ 29.95 ea
BR740A	86643380	2.0m	31	83487	\$ 29.95 ea
BR750	86618414	1.5m Wide	23	83703	\$ 29.95 ea
BR750	86643380	1.8m x.s.	Outer 10	83487	\$ 29.95 ea
BR750	87055364	-	Middle 17	83488	\$ 29.95 ea
BR750	86643380	2.0m	31	83487	\$ 29.95 ea
BR750A	86618414	1.5m Wide	23	83703	\$ 29.95 ea
BR750A	86643380	1.8m x.s.	Outer 10	83487	\$ 29.95 ea
BR750A	87055364	-	Middle 17	83488	\$ 29.95 ea
BR750A	86643380	2.0m	31	83487	\$ 29.95 ea
BR770	87041203	Standard	23	83588	\$ 29.95 ea
BR770A	87041203	Standard	23	83588	\$ 29.95 ea
BR780	87041203	Standard	23	83588	\$ 29.95 ea
BR780	86643380	2.0m	31	83487	\$ 29.95 ea
BR780A	87041203	Standard	23	83588	\$ 29.95 ea
BR780A	86643380	2.0m x.s.	Outer 10	83487	\$ 29.95 ea
BR780A	87055364	-	Middle 21	83488	\$ 29.95 ea
RB450	86618414	1.5m Wide	23	83703	\$ 29.95 ea



POLY PICKUP BANDS

FOR NEW HOLLAND ROUND BALER - Yellow

MODEL	OEM	HEAD SIZE	QTY REQ	PART NO	RETAIL PRICE
RB450	84329281	1.8m	27	83839	\$ 29.95 ea
RB450	84329281	2.0m	31	83839	\$ 29.95 ea
RB460	86618414	1.5m Wide	23	83703	\$ 29.95 ea
RB460	84329281	1.8m	27	83839	\$ 29.95 ea
RB460	84329281	2.0m	31	83839	\$ 29.95 ea
RB550	84370743	1.5m	23	83648	\$ 29.95 ea
RB550	84310058	2.0m	31	83649	\$ 29.95 ea
RB560	84370743	1.5m	23	83648	\$ 29.95 ea
RB560	84310058	2.0m	31	83649	\$ 29.95 ea

FOR NEW HOLLAND SELF-PROPELLED CHOPPER - Yellow

MODEL	OEM	HEAD SIZE	QTY REQ	PART NO	RETAIL PRICE
280FP, 290FP, 380FPA, 380FPE, 346W, 356W, 366W	87696240 86631272 87584380	-	-	83592	\$ 29.95 ea

FOR NEW HOLLAND SMALL SQUARE BALER - Yellow

MODEL	OEM	HEAD SIZE	QTY REQ	PART NO	RETAIL PRICE
27P, 29P, 707W, 717W, 770W, 790W, 880W, 890W, 900W, 919W3, 919W4, 990W	86625275	-	-	83489	\$ 29.95 ea

FOR VERMEER ROUND BALER - Yellow

MODEL	OEM	HEAD SIZE	QTY REQ	PART NO	RETAIL PRICE
I, Super J, J, K, L, XI, Super M, N, Rancher, Rebel 504 Pro, 604 Pro	89982001 510547156	-	-	83706 83818	\$ 29.95 ea \$ 29.95 ea

FOR CLAAS BALERS AND SELF-PROPELLED - Green

MODEL	OEM	HEAD SIZE	QTY REQ	PART NO	RETAIL PRICE
Jaguar, Quadrant, Quantum, Rollant, Variant	987770	-	-	83819	\$ 29.95 ea

FOR JOHN DEERE ROUND BALERS - Green

MODEL	OEM	HEAD SIZE	QTY REQ	PART NO	RETAIL PRICE
330, 335, 375, 385, 430, 435, 447, 448, 449, 456, 458, 459, 466, 467, 468, 469, 535, 545, 546, 547, 550, 556, 558, 559, 566, 567, 568, 569, 570, 572, 580, 582, 590, 592	CC32669 E85043 FH311772	-	-	83478	\$ 29.95 ea
Larger Outer 440 - 569	FH311995	-	-	83845	\$ 29.95 ea
Mega Wide Head Outer 3	FH311994 E96760	-	-	83701	\$ 29.95 ea

FOR JOHN DEERE SELF-PROPELLED HARVESTER - Yellow

MODEL	OEM	HEAD SIZE	QTY REQ	PART NO	RETAIL PRICE
630A, 640A, 645A, 630B, 640B, 645B, 630C, 640C, 645C	CC32669 E85043 FH311772	-	-	83479	\$ 29.95 ea

FOR MCHALE ROUND BALER - Green

MODEL	OEM	HEAD SIZE	QTY REQ	PART NO	RETAIL PRICE
Fusion, Fusion 1, Fusion 3, Fusion 2, Vario, F5, F540, F550, F560, F5400, F5500, F5600, V6, V640, V660, V6740, V6750	CTP00048	-	-	83846	\$ 29.95 ea

FOR MASSEY FERGUSON BALERS - Gray

MODEL	OEM	HEAD SIZE	QTY REQ	PART NO	RETAIL PRICE
Square: 2150, 2170, 2190, 2250, 2270, 2290	700141909 700189742	-	-	83569	\$ 29.95 ea

FOR AGCO BALERS - Gray

MODEL	OEM	HEAD SIZE	QTY REQ	PART NO	RETAIL PRICE
Square: 2150, 2170, 2190, 2250, 2270, 2290	700141909 700189742	-	-	83569	\$ 29.95 ea

Each band comes complete with hardware for easy installation.



POLY PICKUP BANDS



83706

INSTALLATION VIDEO

Vermeer 605 Super M



INSTALLATION VIDEO

John Deere 567 Round Baler





83478

Scan the codes with your phone to watch our installation videos on YouTube.

FOR CHALLENGER SQUARE BALERS - Gray

MODEL	OEM	HEAD SIZE	QTY REQ	PART NO	RETAIL PRICE
7433, 7434, 7444, 7423, 7424	700141909 700189742	-	-	83569	\$ 29.95 ea

FOR HESSTON, NEW IDEA, CHALLENGER SQUARE BALER - Black

MODEL	OEM	HEAD SIZE	QTY REQ	PART NO	RETAIL PRICE
Heston: 4690, 4750, 4755, 4760, 4790	700129658	-	-	83480	\$ 29.95 ea
New Idea: 7233, 7234, 7333					
Challenger: LB33, LB34, LB44					

FOR AGCO, CASE IH, CHALLENGER, HESSTON, MASSEY FERGUSON ROUND BALERS - Black

BRAND	MODEL	OEM	HEAD SIZE	QTY REQ	PART NO	RETAIL PRICE
AGCO:	5446A, 5456A, 5546, 5556A	700132112	-	-	83705	\$ 29.95 ea
Case IH:	8435, RS451, RS551, RS561, RS561A					
Massey	2646A, 2656A, 2746A, 2756A					
Ferguson:						
Hesston:	845, 846A, 855, 856, 856A, 945, 946A, 955, 956					
Challenger:	RB46, RB46B, RB463A, RB56B, RB563A					

FOR KRONE SQUARE BALERS - Green

MODEL	OEM	HEAD SIZE	QTY REQ	PART NO	RETAIL PRICE
Krone SP Chopper EasyFlow 300/380	270152370	-	-	83847	\$ 29.95 ea
Krone Big Pack High Speed Square Baler BP1270, BP1290, BP870, BP890, BP4x4	270204560				

FOR CASE IH, CHALLENGER, HESSTON, MASSEY FERGUSON, NEW IDEA SQ INLINE BALERS - Black

MODEL	OEM	HEAD SIZE	QTY REQ	PART NO	RETAIL PRICE
Case IH: 8520, 8530, 8545	700112379	-	-	83948	\$ 29.95 ea
Challenger: SB34, SB36, SB44	ACX2979210				
Hesston: 4550, 4570, 4590					
Massey: 1835, 1837, 1838, 1839, 1840					
Ferguson:					
New Idea: 7205, 7210, 7215					

Each band comes complete with hardware for easy installation.

HAY KNIFE NEW

SIMPLE BALE WRAP REMOVAL

- Ergonomically designed handle for better control and ease of use
- Cuts twine, mesh, plastic wrap, feed bags, and more
- Loosens frozen or embedded twine
- Hook blades grab the wanted material and preserve the blade
- Suitable for standard utility blades
- 30" length extends your reach



QUESTIONS?
Watch our FAQ video.

SCAN ME



Scan the QR code with your smartphone to watch on YouTube.

83947 - \$ 31.00 ea

RUBBER MOLDED RAKE & BALER TEETH

BLACK TALON



- Reduce Bent Teeth with Flexible Rubber Rake Teeth
- Decrease Leaf Loss
- Reduce Downtime
- Reduce Replacement Costs

QUESTIONS?

Watch our Vermeer 605 Super M installation video.

Scan the QR code with your smartphone to watch on YouTube.

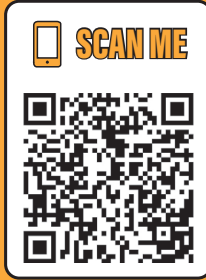

Rubber Tooth FOR Vermeer Baler

	
MODEL	PART NO
Rubber Tooth Vermeer Baler	83945
OEM	RETAIL PRICE
Vermeer 27997051, 27797052	\$ 9.75 ea

Rubber Tooth- Baler

	
MODEL	PART NO
Fits Most Vermeer Baler Models	83942
OEM	RETAIL PRICE
Vermeer 27997-001	\$ 6.30 ea

Rubber Tooth Baler FOR Vermeer

	
MODEL	PART NO
Vermeer 504M, 554XL, 604M, 604 Super M, 604N, 605M, 605N, 605Super M, 6055M	83944
OEM	RETAIL PRICE
Vermeer 27997061, 27997062	\$ 11.10 ea

Rubber Tooth FOR New Holland

	
MODEL	PART NO
New Holland 345, 366, 350, 355, 346, 365, 990, 340, 356, BB940S, BB960S, BB960AR, BR7070, BB940R, BB960R, 585, BB940P, BB900P, BB940AR, BR7090, BR7060	83943
OEM	RETAIL PRICE
New Holland 9847572	\$ 7.35 ea

Rubber Tooth FOR Vermeer Twin Rake

	
MODEL	PART NO
Fits Vermeer R280	83938
OEM	RETAIL PRICE
Vermeer 510501250	\$ 4.85 ea

Rubber Rake Tooth

	
MODEL	PART NO
John Deere 700, 705 Vermeer R-9, R-21, R-23, R-23A, R-24, R-24A	83933
OEM	RETAIL PRICE
John Deere AE56204 Vermeer 2888-001	\$ 3.70 ea

RUBBER MOLDED RAKE & BALER TEETH

Rubber Rake Tooth FOR John Deere

	
MODEL	PART NO
John Deere 70, 71, 640, 650, 652, 660, 662, 670, 671, 672, 673, 896A	83935
OEM	RETAIL PRICE
John Deere AE24953, AE47389	\$ 3.85 ea

Rubber Tooth for Heath Windrowers

	
MODEL	PART NO
Fits Most Heath Models	83937
OEM	RETAIL PRICE
Heath 806-001	\$ 6.00 ea

Rubber Double Rake Tooth

	
MODEL	PART NO
John Deere Circle C Darf Farmhand H&S Morrill New Idea Pequea	83930
OEM	RETAIL PRICE
John Deere 2117 RH Other, 400341 & 491478	\$ 8.05 ea

Rubber Tooth for Bean Windrowers & Ford Balers

	
MODEL	PART NO
Ford 7500630 Henry H60003 Lockwood Innes 504-055 Picket 106000 Four Bar Windrowers- 1997 to Present	83936
OEM	RETAIL PRICE
Ford 7500630 Henry H60003 Lockwood Innes 504-055 Picket 106000	\$ 5.60 ea

GOLD SERIES: Rubber Rake Tooth- RH

	
MODEL	PART NO
New Holland 216, 258 with Right-Hand Hook 260 Rolabar Rake Allen Models Right-Hand Rakes	83934
OEM	RETAIL PRICE
New Holland 139041, 850614	\$ 3.45 ea

SILVER SERIES: Rubber Rake Tooth- LH

	
MODEL	PART NO
New Holland 216, 258 with Left-Hand Hook 259 Rolabar Rake Allen Models Left-Hand Rakes	83941
OEM	RETAIL PRICE
New Holland 65668, 850613	\$ 2.55 ea

GOLD SERIES: Rubber Rake Tooth- LH

	
MODEL	PART NO
New Holland 216, 258 with Left-Hand Hook 259 Rolabar Rake Allen Models Left-Hand Rakes	83932
OEM	RETAIL PRICE
New Holland 65668, 850613	\$ 3.45 ea

SILVER SERIES: Rubber Rake Tooth- RH

	
MODEL	PART NO
New Holland 216, 258 with Right-Hand Hook 260 Rolabar Rake Allen Models Right-Hand Rakes	83940
OEM	RETAIL PRICE
New Holland 139041, 850614	\$ 2.55 ea

GOLD SERIES: Universal Rubber Rake Tooth

	
MODEL	PART NO
Fits most Round Bar and Parallel Bar Rakes with 1 5/8" Bar. John Deere 54, 64, 74, 350, 350A, 640, 650, 652, 660, 662, 670, 671, 673, 851, 858A, 894, 894A, 896, 896A New Holland 55, 56, 57, 256 "Not for use on models with vertical mounting studs"	83931
OEM	RETAIL PRICE
New Holland 65609, 850612 John Deere AE24953, AE47389	\$ 2.95 ea

SILVER SERIES: Universal Rubber Rake Tooth

	
MODEL	PART NO
Fits most Round Bar and Parallel Bar Rakes with 1 5/8" Bar. John Deere 54, 64, 74, 350, 350A, 640, 650, 652, 660, 662, 670, 671, 673, 851, 858A, 894, 894A, 896, 896A New Holland 55, 56, 57, 256 "Not for use on models with vertical mounting studs"	83939
OEM	RETAIL PRICE
New Holland 65609, 850612 John Deere AE24953, AE47389	\$ 2.40 ea

BALER LINERS

Now Available from May Wes! BaleSkiis® Baler Liners!

Small Model Shown Here.
Made for all Square Balers, Large & Small.

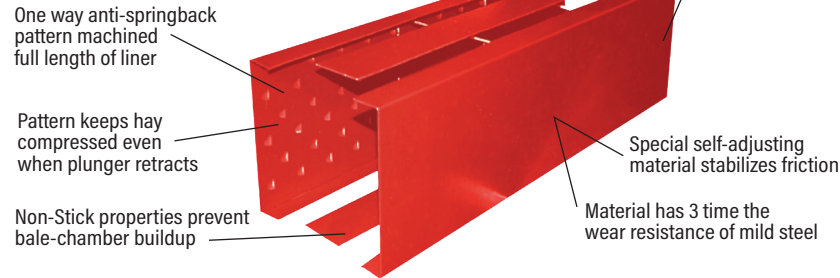

INSTALLATION VIDEO
Case IH LB434

SCAN ME

Featuring **Fast Ag Montana**

HOW DOES IT WORK?

The BaleSkiis® Baler Liner covers the bale-forming chamber with a specially designed, self-adjusting material and an anti-springback pattern machined into the product uniformly compresses the hay and keeps it compressed when the baler plunger retracts. This ensures a constant uniform movement and compression of hay through the bale chamber. This means that the hay is not moving back and forth in the chamber breaking leaves off stems.

- Puts more high protein leaves in the bale - not on the ground.
- Puts more pounds per acre in the bale - not on the ground.
- Reduces the amount of tension in your bale chamber.
- Stops bale chamber plugging & buildup.
- Eliminates wear on your bale chamber.
- Reduces horsepower and fuel consumption.

FOR CASE IH SQUARE BALERS - SMALL

MODEL	PART NO	RETAIL PRICE
Case IH 8545	83950	\$ 1190 ea
Case IH SB521	83968	\$ 1190 ea
Case IH SB531	83969	\$ 1190 ea
Case IH SBX541C	83970	\$ 1255 ea
Case IH SBX541	83971	\$ 1190 ea
Case IH SBX520, SBX530, SBX540	83972	\$ 1190 ea
Case IH SBX541 Extension Chamber	83974	\$ 1190 ea
Case IH SBX520, SBX530, SBX540 Extension Chamber	83975	\$ 1190 ea

FOR MASSEY FERGUSON SQUARE BALERS - SMALL

MODEL	PART NO	RETAIL PRICE
Massey Ferguson 1843s, 1844s	83953	\$ 1405 ea
Massey Ferguson 1835, 1837	83957	\$ 1190 ea
Massey Ferguson 1838	83958	\$ 1190 ea
Massey Ferguson 1839	83959	\$ 1190 ea
Massey Ferguson 1840	83960	\$ 1255 ea
Massey Ferguson 1841	83961	\$ 1405 ea
Massey Ferguson 1842	83962	\$ 1405 ea
Massey Ferguson 9, 10, 12, 120, 124, 128, 130, 224, 228	83963	\$ 1190 ea

FOR HESSTON SQUARE BALERS - SMALL

MODEL	PART NO	RETAIL PRICE
Hesston 4590	83951	\$ 1190 ea
Hesston 4600	83952	\$ 1190 ea
Hesston 4690s	83953	\$ 1405 ea

FOR NEW HOLLAND SQUARE BALERS - SMALL

MODEL	PART NO	RETAIL PRICE
New Holland 315	83964	\$ 1190 ea
New Holland 316	83965	\$ 1190 ea
New Holland 320	83966	\$ 1190 ea
New Holland 326	83967	\$ 1190 ea
New Holland 5050	83968	\$ 1190 ea
New Holland 5060	83969	\$ 1190 ea
New Holland 5070 Hayliner	83970	\$ 1255 ea
New Holland 5070	83971	\$ 1190 ea
New Holland 560, 565, 570, 575	83972	\$ 1190 ea
New Holland 68, 230, 268, 269, 270, 271, 272, 273, 275, 276, 277, 310, 311, 312	83973	\$ 1190 ea
New Holland 5070 Extension Chamber	83974	\$ 1190 ea
New Holland 560, 565, 570, 575 Extension Chamber	83975	\$ 1190 ea

FOR JOHN DEERE SQUARE BALERS - SMALL

MODEL	PART NO	RETAIL PRICE
John Deere 24T, 224, 327, 328, 336, 337, 338	83954	\$ 1190 ea
John Deere 346, 347, 348	83955	\$ 1190 ea
John Deere 468	83956	\$ 1405 ea

FOR AGCO SQUARE BALERS - SMALL

MODEL	PART NO	RETAIL PRICE
AGCO 1843s, 1844s	83953	\$ 1405 ea

BALESKIIS ARE AVAILABLE FOR ANY MAKE/MODEL OF SQUARE BALER.

BALER LINERS

FOR CASE IH SQUARE BALERS - LARGE

MODEL	PART NO	RETAIL PRICE	HEAVY ADD-ON KIT *	PART NO	RETAIL PRICE
Case IH 8575, 8570	83976	\$ 2299 ea	42770	\$ 475 ea	
Case IH LBX432	83977	\$ 2435 ea	42771	\$ 520 ea	
Case IH LBX433, LBX434S, LBX434R	83978	\$ 2435 ea	42772	\$ 520 ea	
Case IH 8585	83982	\$ 2435 ea	42776	\$ 520 ea	

FOR NEW HOLLAND SQUARE BALERS - LARGE

MODEL	PART NO	RETAIL PRICE	HEAVY ADD-ON KIT *	PART NO	RETAIL PRICE
New Holland 340 Plus "Heavy Material Only"	83995	\$ 3368 ea	NA	NA	
New Holland BB940, BB9060, BB330	83996	\$ 2299 ea	42784	\$ 475 ea	
New Holland BB960, BB9040	83997	\$ 2435 ea	42785	\$ 520 ea	
New Holland BB960A, BB9080, BB340	83998	\$ 2435 ea	42786	\$ 520 ea	

FOR JOHN DEERE SQUARE BALERS - LARGE

MODEL	PART NO	RETAIL PRICE	HEAVY ADD-ON KIT *	PART NO	RETAIL PRICE
John Deere L330	83983	\$ 2299 ea	42777	\$ 475 ea	
John Deere L340/341	83984	\$ 2435 ea	42778	\$ 520 ea	

FOR MASSEY FERGUSON SQUARE BALERS - LARGE

MODEL	PART NO	RETAIL PRICE	HEAVY ADD-ON KIT *	PART NO	RETAIL PRICE
Massey 2170	83988	\$ 2435 ea	42780	\$ 520 ea	
Massey 2170XD. "Heavy Material Only"	83989	\$ 2955 ea	NA	NA	
Massey 2190	83990	\$ 2715 ea	42781	\$ 520 ea	
Massey 2250	83991	\$ 2299 ea	42782	\$ 475 ea	
Massey 2270	83992	\$ 2435 ea	42783	\$ 520 ea	
Massey 2270XD "Heavy Material Only"	83993	\$ 3145 ea	NA	NA	
Massey 2290 "Heavy Material Only"	83994	\$ 3463 ea	NA	NA	

FOR HESSTON SQUARE BALERS - LARGE

MODEL	PART NO	RETAIL PRICE	HEAVY ADD-ON KIT *	PART NO	RETAIL PRICE
Hesston 4790	83982	\$ 2435 ea	42776	\$ 520 ea	
Hesston 4755	83980	\$ 2299 ea	42774	\$ 475 ea	
Hesston 4760	83981	\$ 2299 ea	42775	\$ 475 ea	

FOR KRONE SQUARE BALERS - LARGE

MODEL	PART NO	RETAIL PRICE	HEAVY ADD-ON KIT *	PART NO	RETAIL PRICE
Krone 1290	83985	\$ 2435 ea	42779	\$ 520 ea	
Krone 1290HDP "Heavy Material only"	83986	\$ 3368 ea	NA	NA	
Krone Big Pack 1290 HDPII & XC. "Heavy Material Only"	83987	\$ 2435 ea	NA	NA	

FOR CAT SQUARE BALERS - LARGE

MODEL	PART NO	RETAIL PRICE	HEAVY ADD-ON KIT *	PART NO	RETAIL PRICE
Cat LB34	83982	\$ 2410 ea	42776	\$ 520 ea	

FOR CLAAS SQUARE BALERS - LARGE

MODEL	PART NO	RETAIL PRICE	HEAVY ADD-ON KIT *	PART NO	RETAIL PRICE
Class 5300	83979	\$ 2435 ea	42773	\$ 520 ea	

*Heavy material kits are recommended for those baling in rough forage, and/or very abrasive soils and/or extreme temperatures.

Please contact us if your baler has other modifications or if you do not see your baler model listed here. BaleSkiis are available for any make/model of square baler. Unless noted, all kits are available in heavy or regular material.

If you will be baling corn stalks, ask for the "Corn Kit" add-on, at no extra cost at the time of ordering. Extra costs are incurred if ordered as a separate item later.

PREMIUM POLY SKID SHOES - HARDWARE INCLUDED



EXTEND THE LIFE OF YOUR HEAD AND PUT MORE CROP IN THE COMBINE.

FORMED TO FIT. PREDRILLED COUNTERBORED HOLES. HARDWARE INCLUDED.

Poly Skid Shoes prevent soil and debris build-up on the underside of your combine head. The smooth, slick surface allows you to run your head and cutterbar down as low as possible, leaving little to no crop in the field. Durable UHMW skid shoes protect your OEM metal skid plates, extending the life of your head.

MACHINE CUT FROM SOLID SHEETS OF UHMW POLY OR COMPRESSION MOLDED TO FIT YOUR HEAD.



Predrilled & Counterbored Holes Protect Hardware. All Hardware is Included with Skid Shoes.

NEW

CUTTERBAR SKID SHOES

Sold individually or in packs of 10. Reuse your OEM hardware.

Compatible Drapers

Case IH
2162/2152/2142

MacDon
FD1/FD/D

New Holland
86C/83C/84C

Featured by Fast Ag Montana. Scan the QR code to watch now.

QUESTIONS?

Watch our Skid Shoe FAQ video.

Scan the QR code with your smartphone to watch our FAQ video on YouTube.

PREMIUM POLY SKID SHOES - HARDWARE INCLUDED

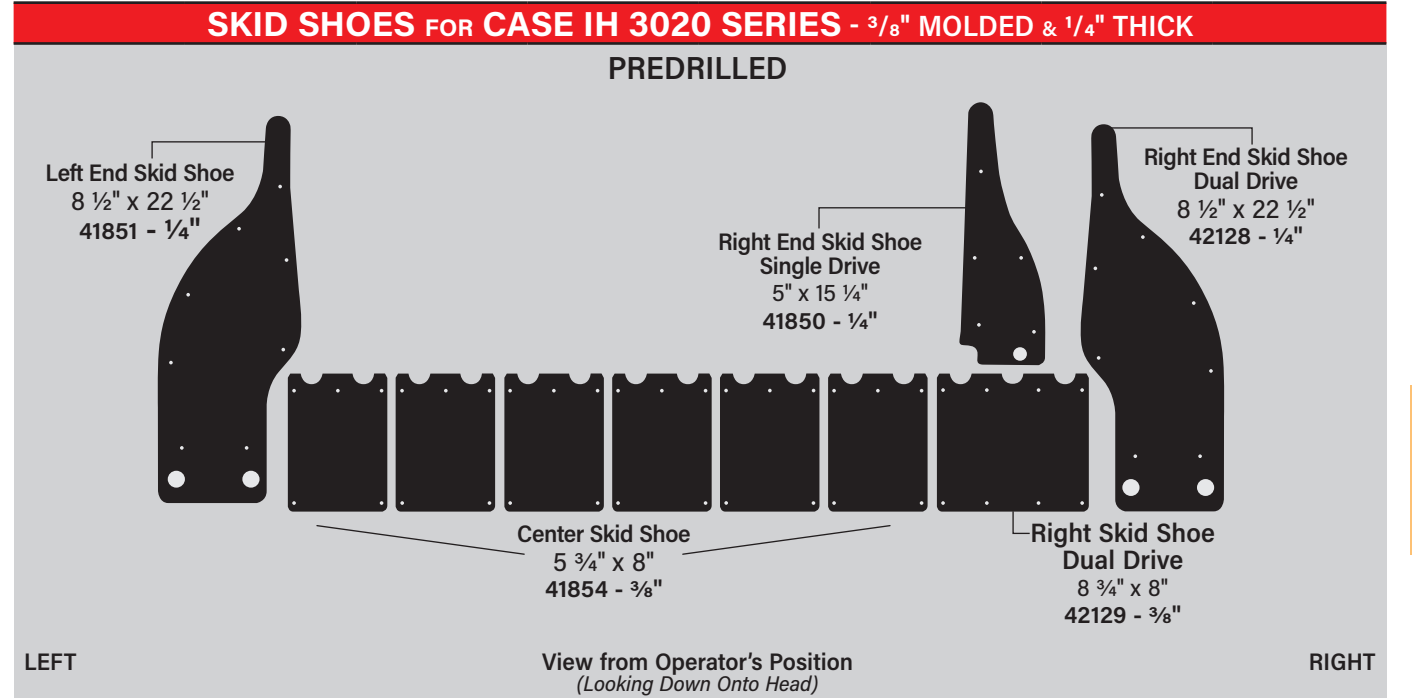

KITS FOR CASE IH 3020 SERIES - 3/8" MOLDED & 1/4" THICK

SET SIZE	SHOE THICKNESS	PD*	PART NO BLACK DUAL DRIVE	PART NO BLACK SINGLE DRIVE	RETAIL PRICE
35 ft	3/8" Molded Centers & 1/4" Ends	PD	83558	83314	\$ 880 set
30 ft	3/8" Molded Centers & 1/4" Ends	PD	83559	83315	\$ 769 set
25 ft	3/8" Molded Centers & 1/4" Ends	PD	83560	83316	\$ 659 set
20 ft	3/8" Molded Centers & 1/4" Ends	PD	83561	83317	\$ 549 set

NOTE: Center Skid Shoes are 3/8" thick molded. End Skid Shoes are 1/4" thick and are not molded.

REPLACEMENT PARTS FOR CASE IH 3020 SERIES - 3/8" MOLDED & 1/4" THICK

DESCRIPTION	SHOE THICKNESS	SIZE	PD*	PART NO BLACK DUAL DRIVE	PART NO BLACK SINGLE DRIVE	RETAIL PRICE
Right End Skid Shoe	1/4"	5" x 15 1/4"	PD	-	41850	\$ 45 ea
Right End Skid Shoe	1/4"	8 1/2" x 22 1/2"	PD	42128	-	\$ 61 ea
Right Skid Shoe	3/8" Molded	8 3/4" x 8"	PD	42129	-	\$ 32 ea
Left Skid Shoe	1/4"	8 1/2" x 22 1/2"	PD	41851	41851	\$ 61 ea
Center Skid Shoe	3/8" Molded	5 3/4" x 8"	PD	41854	41854	\$ 21 ea

*PD = Predrilled
Hardware included = Size 86 Small Head Pop Rivets. Extra rivets can be purchased on page 149.

COMPRESSION MOLDED FOR IMPROVED DURABILITY.

THICKNESS WHERE IT IS NEEDED THE MOST

CASE IH

THICKER IN CRITICAL WEAR AREA

THIN FOR DIRT FLOW AND MOUNTING EASE

PREMIUM POLY SKID SHOES - HARDWARE INCLUDED

SKID SHOES FOR CASE IH 2020 SERIES
 PIN: CBJ021301 & LATER, Y9ZL & YAZL - 1/4" THICK

PREDRILLED

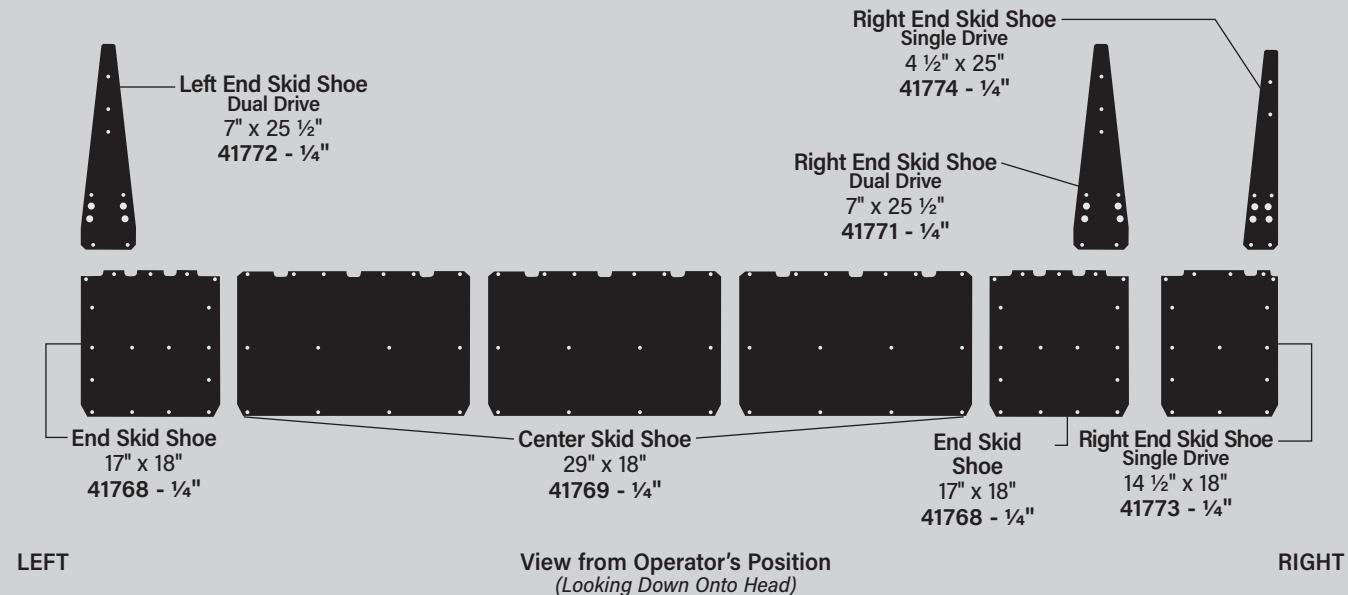

KITS FOR CASE IH 2020 SERIES - PIN: CBJ021301 & LATER - 1/4" THICK

SET SIZE	SHOE THICKNESS	PD*	PART NO BLACK DUAL DRIVE	PART NO BLACK SINGLE DRIVE	RETAIL PRICE
35 ft	1/4"	PD	82918	-	\$ 1417 set
30 ft	1/4"	PD	82919	-	\$ 1216 set
25 ft	1/4"	PD	82920	82922	\$ 1028 set
20 ft	1/4"	PD	82921	82923	\$ 834 set

REPLACEMENT PARTS FOR CASE IH 2020 SERIES - PIN: CBJ021301 & LATER - 1/4" THICK

DESCRIPTION	SHOE THICKNESS	SIZE	PD*	PART NO BLACK DUAL DRIVE	PART NO BLACK SINGLE DRIVE	RETAIL PRICE
End Skid Shoe	1/4"	17" x 18"	PD	41768	41768	\$ 99 ea
Center Skid Shoe	1/4"	29" x 18"	PD	41769	41769	\$ 113 ea
Right End Skid Shoe	1/4"	14 1/2" x 18"	PD	-	41773	\$ 93 ea
Right End Skid Shoe	1/4"	4 1/2" x 25"	PD	-	41774	\$ 52 ea
Right End Skid Shoe	1/4"	7" x 25 1/2"	PD	41771	-	\$ 65 ea
Left End Skid Shoe	1/4"	7" x 25 1/2"	PD	41772	-	\$ 65 ea

*PD = Predrilled
 Hardware included = Size 86 Small Head Pop Rivets. Extra rivets can be purchased on page 149.



PREMIUM POLY SKID SHOES - HARDWARE INCLUDED

SKID SHOES FOR CASE IH 2020 SERIES
 PIN: CBJ020701 - CBJ021300 - 1/4" THICK

PREDRILLED

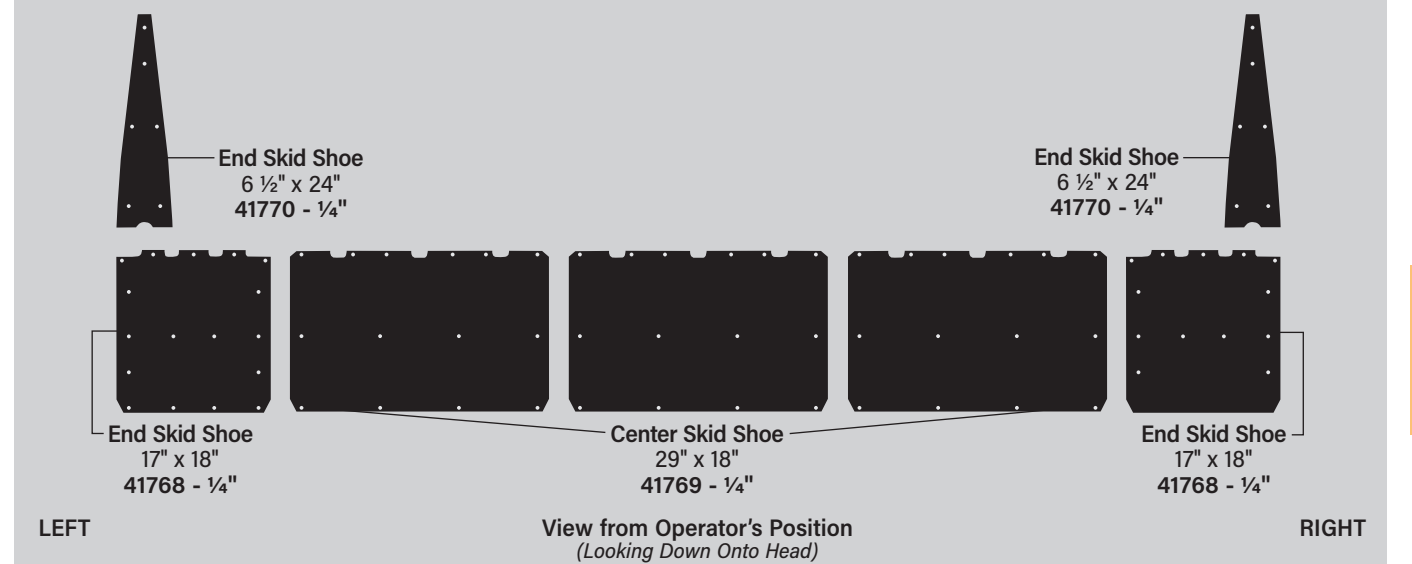

KITS FOR CASE IH 2020 SERIES - PIN: CBJ020701 - CBJ021300 - 1/4" THICK

SET SIZE	SHOE THICKNESS	PD*	PART NO BLACK	RETAIL PRICE
30 ft	1/4"	PD	82915	\$ 1216 set
25 ft	1/4"	PD	82916	\$ 1028 set
20 ft	1/4"	PD	82917	\$ 834 set

REPLACEMENT PARTS FOR CASE IH 2020 SERIES - PIN: CBJ020701 - CBJ021300 - 1/4" THICK

DESCRIPTION	SHOE THICKNESS	PD*	SIZE	PART NO BLACK	RETAIL PRICE
End Skid Shoe	1/4"	PD	17" x 18"	41768	\$ 99 ea
Center Skid Shoe	1/4"	PD	29" x 18"	41769	\$ 113 ea
End Shoe	1/4"	PD	6 1/2" x 24"	41770	\$ 57 ea

*PD = Predrilled
 Hardware included = Size 86 Small Head Pop Rivets. Extra rivets can be purchased on page 149.

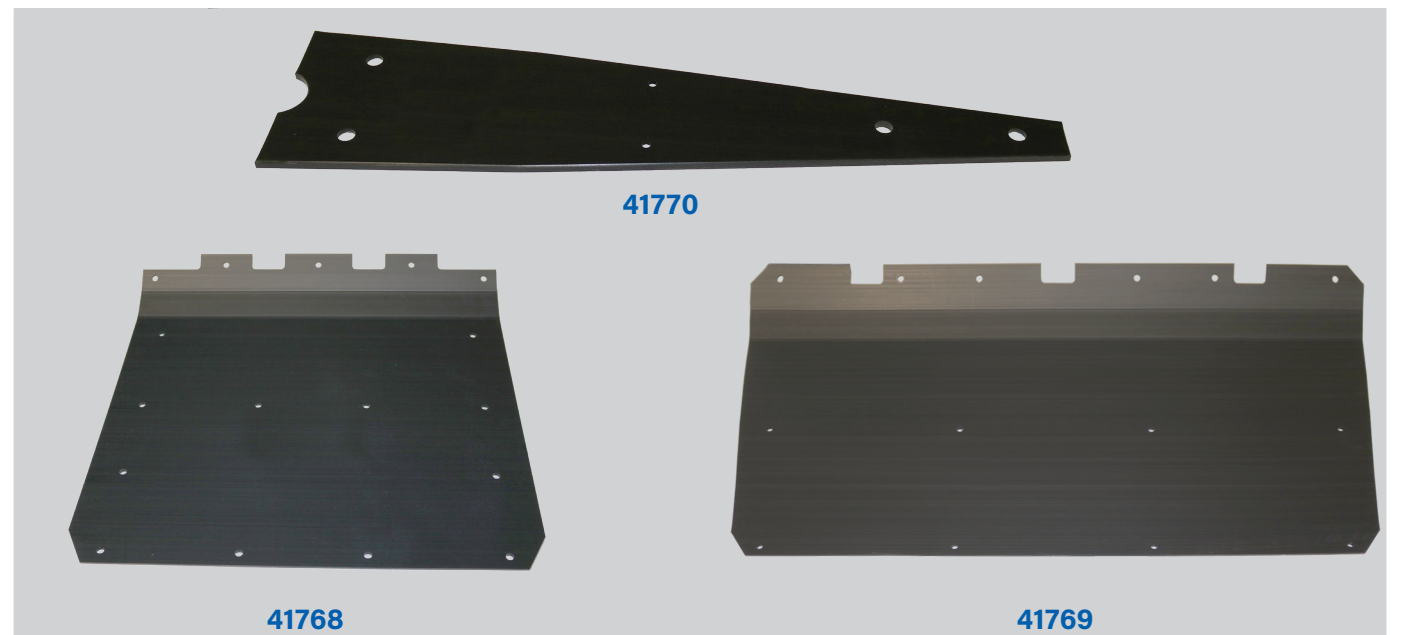

SKID SHOES

PREMIUM POLY SKID SHOES - HARDWARE INCLUDED

SKID SHOES FOR CASE IH 2020 SERIES
PIN: CBJ020001 - CBJ020700 - 1/4" THICK

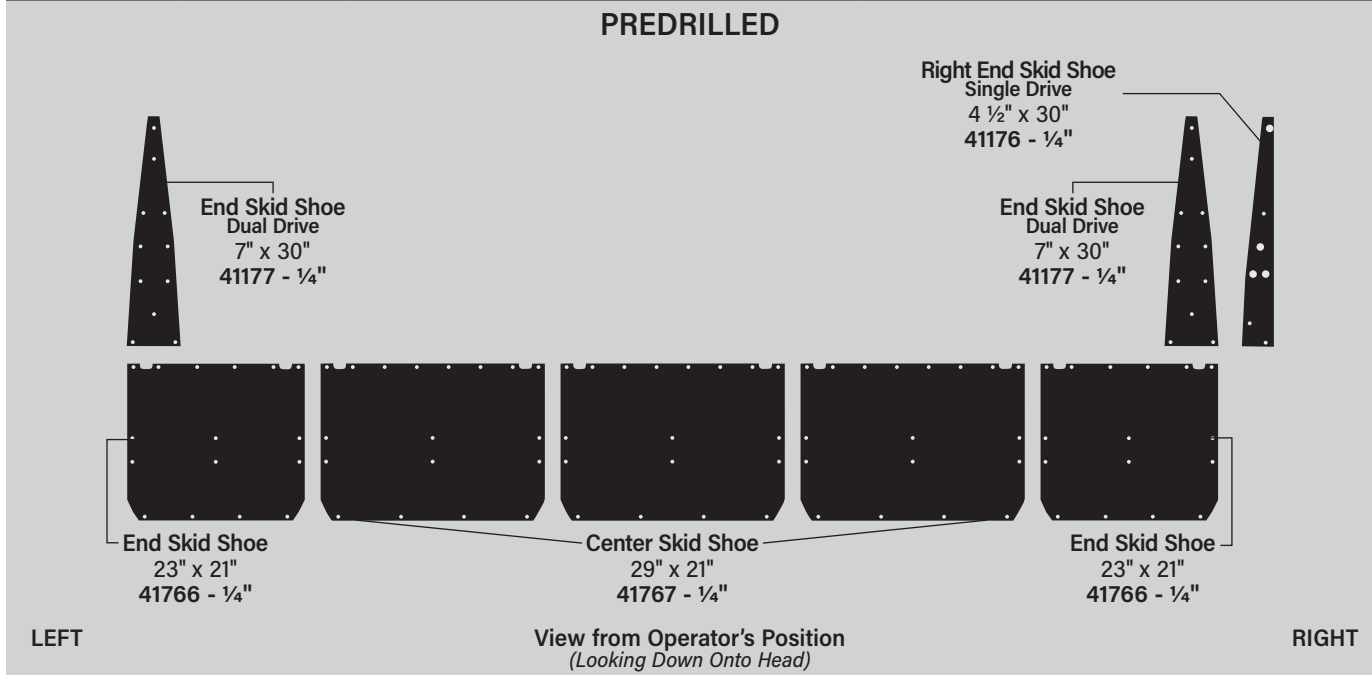

KITS FOR CASE IH 2020 SERIES - PIN: CBJ020001 - CBJ020700 - 1/4" THICK

SET SIZE	SHOE THICKNESS	PD*	PART NO BLACK	RETAIL PRICE
30 ft	1/4"	PD	82911	\$ 1211 set
25 ft	1/4"	PD	82912	\$ 1028 set
20 ft	1/4"	PD	82913	\$ 834 set

REPLACEMENT PARTS FOR CASE IH 2020 SERIES - PIN: CBJ020001 - CBJ020700 - 1/4" THICK

DESCRIPTION	SHOE THICKNESS	PD*	SIZE	PART NO BLACK	RETAIL PRICE
End Skid Shoe	1/4"	PD	23" x 21"	41766	\$ 97 ea
Center Skid Shoe	1/4"	PD	29" x 21"	41767	\$ 113 ea
End Skid Shoe Dual Drive	1/4"	PD	7" x 30"	41177	\$ 66 ea
Right End Skid Shoe Single Drive	1/4"	PD	4 1/2" x 30"	41176	\$ 51 ea

*PD = Predrilled
 Hardware included = Size 86 Small Head Pop Rivets. Extra rivets can be purchased on page 149.

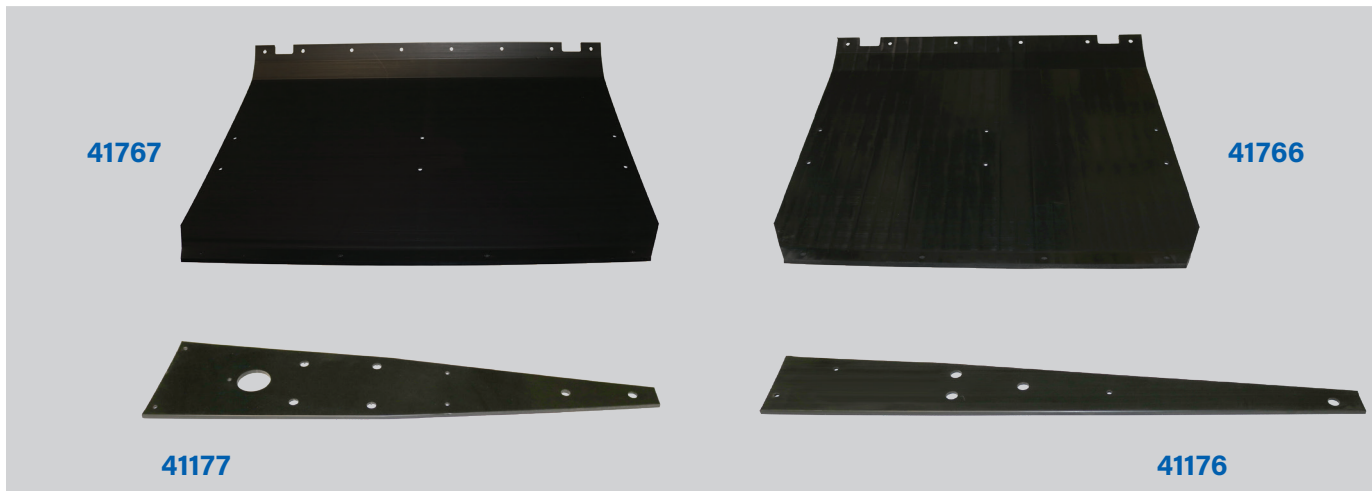

PREMIUM POLY SKID SHOES - HARDWARE INCLUDED

SKID SHOES FOR CASE IH 2020 SERIES
PIN: BEFORE CBJ020001 INCLUDING ALL HAJ PIN'S - 1/4" THICK

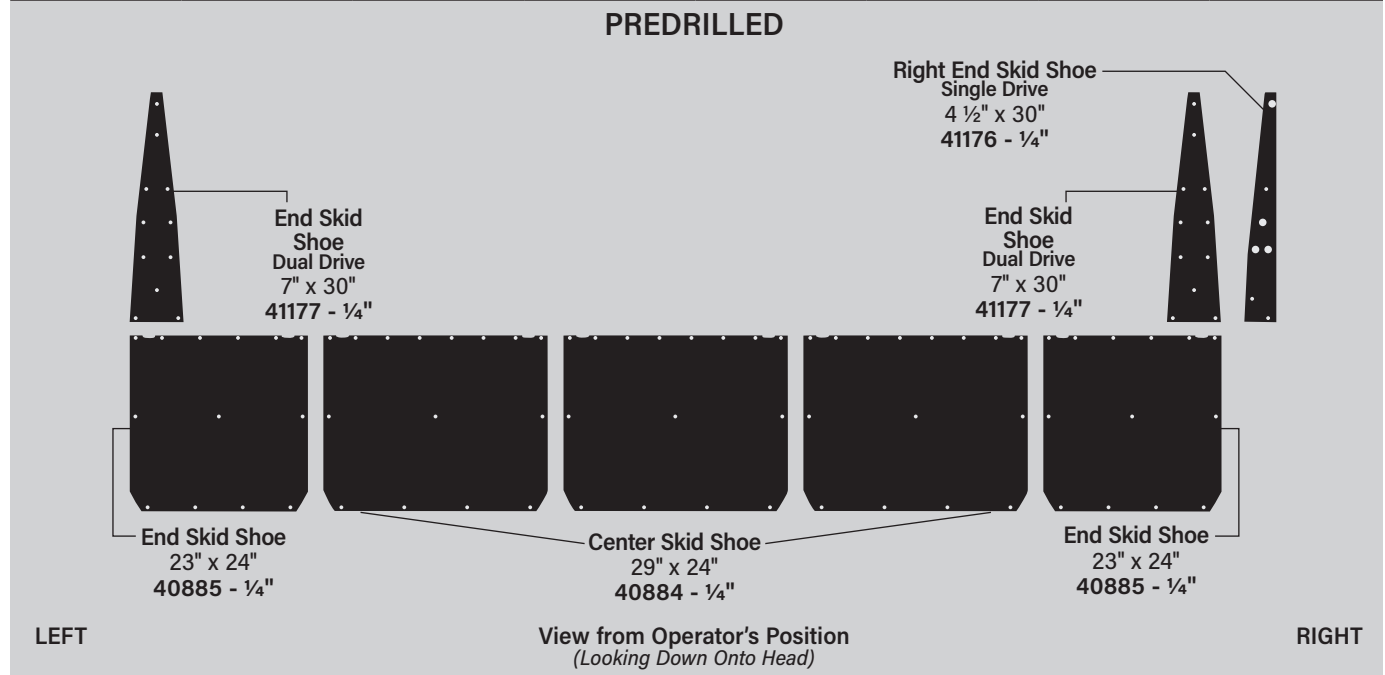

KITS FOR CASE IH 2020 SERIES - PIN: BEFORE CBJ020001 INCLUDING ALL HAJ PIN'S - 1/4" THICK

SET SIZE	SHOE THICKNESS	PD*	PART NO BLACK	RETAIL PRICE
30 ft	1/4"	PD	82179	\$ 1211 set
25 ft	1/4"	PD	82180	\$ 1028 set
20 ft	1/4"	PD	82183	\$ 835 set

REPLACEMENT PARTS FOR CASE IH 2020 SERIES - PIN: BEFORE CBJ020001 INCLUDING ALL HAJ PIN'S - 1/4" THICK

DESCRIPTION	SHOE THICKNESS	PD*	SIZE	PART NO BLACK	RETAIL PRICE
End Skid Shoe	1/4"	PD	23" x 24"	40885	\$ 99 ea
Center Skid Shoe	1/4"	PD	29" x 24"	40884	\$ 113 ea
End Skid Shoe Dual Drive	1/4"	PD	7" x 30"	41177	\$ 66 ea
Right End Skid Shoe Single Drive	1/4"	PD	4 1/2" x 30"	41176	\$ 51 ea

*PD = Predrilled
 Hardware included = Size 86 Small Head Pop Rivets. Extra rivets can be purchased on page 149.



PREMIUM POLY SKID SHOES - HARDWARE INCLUDED

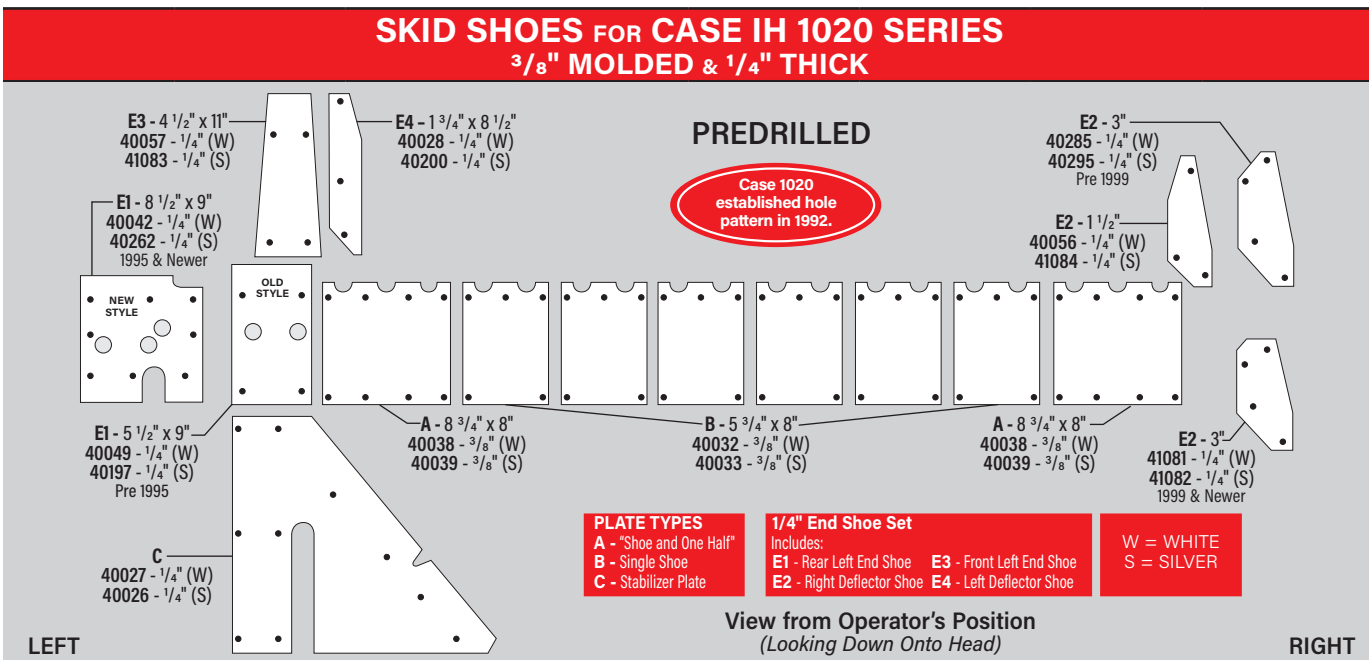

KITS FOR CASE IH 1020 SERIES - $\frac{3}{8}$ " MOLDED & $\frac{1}{4}$ " THICK

SET SIZE	SHOE THICKNESS	PD*	PART NO - SILVER	PART NO - WHITE	RETAIL PRICE
30 ft	$\frac{3}{8}$ " Molded Centers & $\frac{1}{4}$ " Ends	PD	81741	81731	\$ 812 set
25 ft	$\frac{3}{8}$ " Molded Centers & $\frac{1}{4}$ " Ends	PD	81740	81730	\$ 731 set
22 1/2 ft	$\frac{3}{8}$ " Molded Centers & $\frac{1}{4}$ " Ends	PD	81739	81729	\$ 677 set
20 ft	$\frac{3}{8}$ " Molded Centers & $\frac{1}{4}$ " Ends	PD	81738	81728	\$ 623 set
17 1/2 ft	$\frac{3}{8}$ " Molded Centers & $\frac{1}{4}$ " Ends	PD	81737	81727	\$ 569 set
16 1/2 ft	$\frac{3}{8}$ " Molded Centers & $\frac{1}{4}$ " Ends	PD	81736	81726	\$ 514 set
15 ft	$\frac{3}{8}$ " Molded Centers & $\frac{1}{4}$ " Ends	PD	81735	81725	\$ 461 set

NOTE: Center Shoes (A & B) are $\frac{3}{8}$ " thick molded. ALL End Shoes are $\frac{1}{4}$ " and are not molded. Kits include End Shoe (E1) and both 1.5" and 3" Deflector Shoe (E2) for Pre-1995, 1995 & Newer models. *PD = Predrilled

REPLACEMENT PARTS FOR CASE IH 1020 SERIES - $\frac{3}{8}$ " MOLDED & $\frac{1}{4}$ " THICK

DESCRIPTION	SHOE THICKNESS	PD*/UD**	SIZE	PART NO - SILVER	PART NO - WHITE	RETAIL PRICE
Set of 7 End Shoes	$\frac{1}{4}$ "	PD	E1, E2, E3, & E4	82105	80160	\$ 88 ea
Shoe and One Half	$\frac{3}{8}$ " Molded	PD	(A) $8\frac{3}{4}$ " x 8"	40039	40038	\$ 29 ea
Single Shoe	$\frac{3}{8}$ " Molded	PD	(B) $5\frac{3}{4}$ " x 8"	40033	40032	\$ 19 ea
Rear Left Shoe - 1995 & Newer (Serial #JJC0215001 and up)	$\frac{1}{4}$ "	PD	(E1) $8\frac{1}{2}$ " x 9"	40262	40042	\$ 38 ea
Rear Left End Shoe - Before 1995	$\frac{1}{4}$ "	PD	(E1) $5\frac{1}{2}$ " x 9"	40197	40049	\$ 27 ea
Right Deflector Shoe	$\frac{1}{4}$ "	PD	(E2) for 1 1/2" Knife	41084	40056	\$ 29 ea
Right Deflector Shoe	$\frac{1}{4}$ "	PD	(E2) for 3" Knife - Before 1999	40295	40285	\$ 29 ea
Right Deflector Shoe	$\frac{1}{4}$ "	PD	(E2) for 3" Knife - 1999 & Newer	41082	41081	\$ 29 ea
Front Left End Shoe	$\frac{1}{4}$ "	PD	(E3) 11 " x $4\frac{1}{2}$ "	41083	40057	\$ 26 ea
Left Deflector Shoe	$\frac{1}{4}$ "	PD	(E4) $1\frac{3}{4}$ " x $8\frac{1}{2}$ "	40200	40028	\$ 23 ea
Stabilizer Plate	$\frac{1}{4}$ "	PD	(C) $20\frac{1}{2}$ " x 18 "	40026	40027	\$ 93 ea
Stabilizer Plate - Oversized	$\frac{1}{4}$ "	PD	(C) 30 " x 30 "	N/A	41028	\$ 92 ea
A-Frame Stabilizer Plate (Serial #3250000 & Up) (2 pieces)	$\frac{1}{4}$ "	PD	(C)	82631	82630	\$ 93 ea
Extended Skid Shoe	$\frac{1}{4}$ "	PD	6 " x $17\frac{1}{2}$ "	N/A	80133	\$ 21 ea

*PD = Predrilled **UD = Undrilled
 Hardware included = Size 10-16 & 16-16 Pound Rivets. Extra rivets can be purchased on page 149.

PREMIUM POLY SKID SHOES - HARDWARE INCLUDED

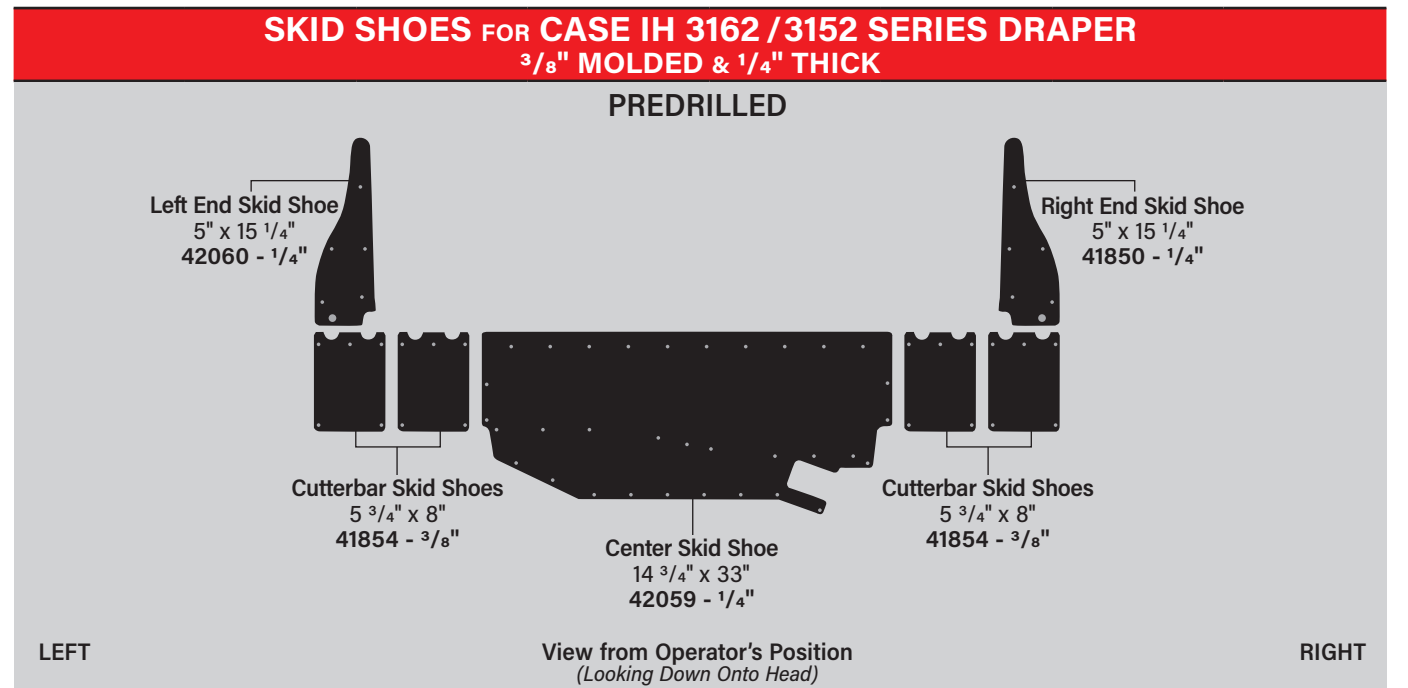

KITS FOR CASE IH 3162 / 3152 SERIES DRAPER - $\frac{3}{8}$ " & $\frac{1}{4}$ " THICK

SET SIZE	SHOE THICKNESS	PD*	PART NO BLACK	RETAIL PRICE
45 ft	$\frac{3}{8}$ " Molded Cutterbars & $\frac{1}{4}$ " Center/Ends	PD	83476	\$ 1273 set
40 ft	$\frac{3}{8}$ " Molded Cutterbars & $\frac{1}{4}$ " Center/Ends	PD	83475	\$ 1108 set
35 ft	$\frac{3}{8}$ " Molded Cutterbars & $\frac{1}{4}$ " Center/Ends	PD	83474	\$ 964 set
30 ft	$\frac{3}{8}$ " Molded Cutterbars & $\frac{1}{4}$ " Center/Ends	PD	83473	\$ 812 set
25 ft	$\frac{3}{8}$ " Molded Cutterbars & $\frac{1}{4}$ " Center/Ends	PD	83470	\$ 690 set

NOTE: Cutterbar Skid Shoes are $\frac{3}{8}$ " thick molded. Both Center and End Skid Shoes are $\frac{1}{4}$ " thick and are not molded.

REPLACEMENT PARTS FOR CASE IH 3162 / 3152 SERIES DRAPER - $\frac{3}{8}$ " & $\frac{1}{4}$ " THICK

DESCRIPTION	SHOE THICKNESS	PD*	SIZE	PART NO BLACK	RETAIL PRICE
Left End Skid Shoe	$\frac{1}{4}$ "	PD	5 " x $15\frac{1}{4}$ "	42060	\$ 45 ea
Right End Skid Shoe	$\frac{1}{4}$ "	PD	5 " x $15\frac{1}{4}$ "	41850	\$ 45 ea
Center Skid Shoe	$\frac{1}{4}$ "	PD	$14\frac{3}{4}$ " x 33 "	42059	\$ 139 ea
Cutterbar Skid Shoe	$\frac{3}{8}$ " Molded	PD	$5\frac{3}{4}$ " x 8 "	41854	\$ 21 ea

*PD = Predrilled
 Hardware included = 86 Small Head Pop Rivets. Extra rivets can be purchased on page 149.
 Part 42059 (Center Skid Shoe) uses M6 Bolts.



PREMIUM POLY SKID SHOES - HARDWARE INCLUDED

SKID SHOES FOR CASE IH 2162 / 2152 / 2142 SERIES DRAPER - 3/8" THICK

THICKER
than OEM

PREDRILLED

Cutterbar Skid Shoe - 6" x 6.5"
22723/83840 - 3/8"
(Order separately - NOT INCLUDED in kits)

Transition Pan Skid Shoe - 7" x 19"
42061 - 3/8"
(Order separately - NOT INCLUDED in kits)

Left End Skid Shoe
11" x 15"
42054 - 3/8"

Center Skid Shoe
14" x 16"
42053 - 3/8"

Right End Skid Shoe
11" x 15"
42055 - 3/8"

ORDER SEPARATELY - NOT INCLUDED IN KITS
DUE TO LARGE SIZE, ADDITIONAL SHIPPING FEE MAY APPLY

Draper Skid Plate
35 3/16" x 76 5/8"
42299 - 1/4"
Order separately - NOT INCLUDED in kits

Center Skid Shoe Assembly
14" x 16"
42319 - 3/8"
(Order separately - NOT INCLUDED in kits)

View from Operator's Position
(Looking Down Onto Head)

Cutterbar Skid Shoe Qty Required	
HEAD WIDTH	QUANTITY
30'	60
35'	70
40'	80
45'	90

KITS FOR CASE IH 2162 / 2152 / 2142 SERIES DRAPER - 3/8" THICK

SET SIZE	SHOE THICKNESS	PD*	PART NO - BLACK	RETAIL PRICE
45 ft	3/8" Centers & Ends	PD	83490	\$ 360 set
40 ft	3/8" Centers & Ends	PD	83490	\$ 360 set
35 ft	3/8" Centers & Ends	PD	83490	\$ 360 set
30 ft	3/8" Centers & Ends	PD	83490	\$ 360 set

REPLACEMENT PARTS FOR CASE IH 2162 / 2152 / 2142 SERIES DRAPER - 3/8" THICK

DESCRIPTION	SHOE THICKNESS	PD*	SIZE	PART NO - BLACK	RETAIL PRICE
Left End Skid Shoe	3/8"	PD	11" x 15"	42054	\$ 63 ea
Right End Skid Shoe	3/8"	PD	11" x 15"	42055	\$ 63 ea
Center Skid Shoe	3/8"	PD	14" x 16"	42053	\$ 65 ea
Transition Pan Skid Shoe <i>Sold Separately</i>	3/8"	PD	7" x 19"	42061	\$ 47 ea
Center Skid Shoe Assembly <i>Sold Separately. Includes Metal Skid Plate, Poly Skid Shoe & Hardware.</i>	3/8"	PD	14" x 16"	42319	\$ 196 ea
Draper Skid Plate <i>Sold Separately</i>	1/4"	PD	35 3/16" x 76 5/8"	42299	\$ 347 ea
Cutterbar Skid Shoe <i>Sold Separately. Hardware not included. Reuse OEM hardware.</i>	3/8" Molded	PD	6" x 6 1/2"	22723	\$ 12 ea
Cutterbar Skid Shoe - 10pk <i>Sold Separately. Hardware not included. Reuse OEM hardware.</i>	3/8" Molded	PD	6" x 6 1/2"	83840	\$ 109 pk

*PD = Predrilled Hardware included = Nuts & Bolts

Center Skid Shoe Assembly
14" x 16"
3/8" Thickness
42319 \$ 196

Includes Metal Skid Plate, Poly Skid Shoe & Mounting Hardware

Reuse your Factory OEM Mount Brackets for Installation

Questions? Scan the code to learn more.

PREMIUM POLY SKID SHOES - HARDWARE INCLUDED

SKID SHOES FOR CASE IH 2062 / 2052 SERIES DRAPER 2062 AFTER SERIAL #CCC0015328 / 2052 AFTER SERIAL #CCC0014710 - 3/8" THICK

THICKER
than OEM

PREDRILLED

Cutterbar Skid Shoe - 6" x 6.5"
22723/83840 - 3/8"
(Order separately - NOT INCLUDED in kits)

Left End Skid Shoe
3" x 8 1/2"
42056 - 3/8"

Center Skid Shoe
17 1/4" x 23"
41567 - 3/8"

Right End Skid Shoe
3" x 8 1/2"
42057 - 3/8"

Outer Skid Shoe
11 3/4" x 15"
41566 - 3/8"

Outer Skid Shoe
11 3/4" x 15"
41566 - 3/8"

Cutterbar Skid Shoe Qty Required	
HEAD WIDTH	QUANTITY
30'	60
35'	70
40'	80
45'	90

KITS FOR CASE IH 2062 SERIES DRAPER - AFTER SERIAL #CCC0015328 - 3/8" THICK

SET SIZE	SHOE THICKNESS	PD*	PART NO - WHITE	RETAIL PRICE
36 ft	3/8"	PD	83502	\$ 551 set
30 ft	3/8"	PD	83502	\$ 551 set

KITS FOR CASE IH 2052 SERIES DRAPER - AFTER SERIAL #CCC0014710 - 3/8" THICK

SET SIZE	SHOE THICKNESS	PD*	PART NO - WHITE	RETAIL PRICE
39 ft	3/8"	PD	83500	\$ 392 set
36 ft	3/8"	PD	83500	\$ 392 set
30 ft	3/8"	PD	83500	\$ 392 set
25 ft	3/8"	PD	83501	\$ 220 set
21 ft	3/8"	PD	83501	\$ 220 set

REPLACEMENT PARTS FOR CASE IH 2062 / 2052 SERIES DRAPER - AFTER SERIAL # BREAKS - 3/8" THICK

DESCRIPTION	SHOE THICKNESS	PD*	SIZE	PART NO - WHITE	RETAIL PRICE
Left End Skid Shoe	3/8"	PD	3" x 8 1/2"	42056	\$ 29 ea
Right End Skid Shoe	3/8"	PD	3" x 8 1/2"	42057	\$ 29 ea
Center Skid Shoe	3/8"	PD	17 1/4" x 23"	41567	\$ 83 ea
Outer Skid Shoe	3/8"	PD	11 1/4" x 15"	41566	\$ 40 ea
Cutterbar Skid Shoe <i>Sold Separately. Hardware not included. Reuse OEM hardware.</i>	3/8" Molded	PD	6" x 6 1/2"	22723	\$ 12 ea
Cutterbar Skid Shoe - 10pk <i>Sold Separately. Hardware not included. Reuse OEM hardware.</i>	3/8" Molded	PD	6" x 6 1/2"	83840	\$ 109 pk

*PD = Predrilled Hardware included = Nuts & Bolts
Part 41567 (Center Skid Shoe) uses 68 Small Head Pop Rivets. Extra rivets can be purchased on page 149.

42056

41567

41566

22723/83840

42057

PREMIUM POLY SKID SHOES - HARDWARE INCLUDED

SKID SHOES FOR CASE IH 2062 / 2052 SERIES DRAPER
2062 BEFORE SERIAL #CCC0015328 / 2052 BEFORE SERIAL #CCC0014710 - 3/8" THICK

PREDRILLED

THICKER than OEM

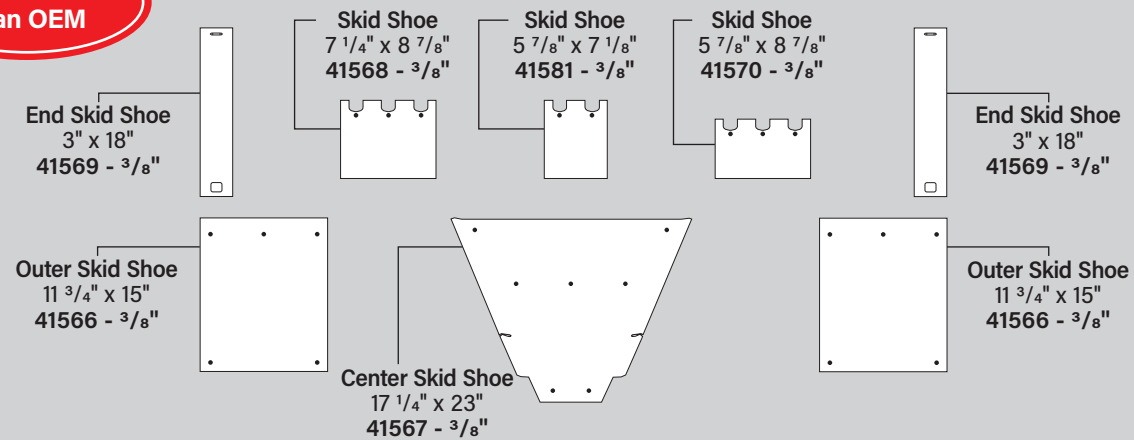

LEFT

View from Operator's Position
(Looking Down Onto Head)

RIGHT

KITS FOR CASE IH 2062 SERIES DRAPER - BEFORE SERIAL #CCC0015328 - 3/8" THICK

SET SIZE	SHOE THICKNESS	PD*	PART NO - WHITE	RETAIL PRICE
36 ft	3/8"	PD	82576	\$ 1360 set
30 ft	3/8"	PD	82577	\$ 1185 set

KITS FOR CASE IH 2052 SERIES DRAPER - BEFORE SERIAL #CCC0014710 - 3/8" THICK

SET SIZE	SHOE THICKNESS	PD*	PART NO - WHITE	RETAIL PRICE
39 ft	3/8"	PD	83499	\$ 1650 set
36 ft	3/8"	PD	83498	\$ 1329 set
30 ft	3/8"	PD	83497	\$ 1144 set
25 ft	3/8"	PD	83496	\$ 958 set
21 ft	3/8"	PD	83495	\$ 820 set

REPLACEMENT PARTS FOR CASE IH 2062 / 2052 SERIES DRAPER - BEFORE SERIAL # BREAKS - 3/8" THICK

DESCRIPTION	SHOE THICKNESS	PD*	SIZE	PART NO - WHITE	RETAIL PRICE
End Skid Shoe	3/8"	PD	3" x 18"	41569	\$ 43 ea
Outer Skid Shoe	3/8"	PD	11 3/4" x 15"	41566	\$ 40 ea
Center Skid Shoe	3/8"	PD	17 1/4" x 23"	41567	\$ 83 ea
Skid Shoe	3/8"	PD	7 1/4" x 8 7/8"	41568	\$ 31 ea
Skid Shoe	3/8"	PD	5 7/8" x 7 1/8"	41581	\$ 29 ea
Skid Shoe	3/8"	PD	5 7/8" x 8 7/8"	41570	\$ 29 ea

*PD = Predrilled
Hardware included = Nuts & Bolts
Parts 41567, 41568, 41581 and 41570 use 68 Small Head Pop Rivets. Extra rivets can be purchased on page 149.

5-FINGER QUICK TINES

**Keep More Bushels
In Your Machine**

Learn more on page 123

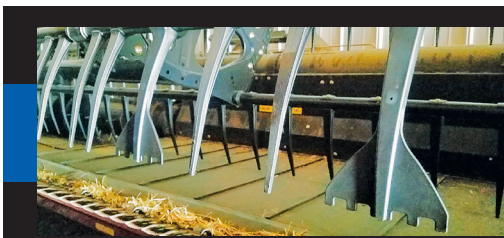

PREMIUM POLY SKID SHOES - HARDWARE INCLUDED

SKID SHOES FOR NEW HOLLAND 740CF SERIES
3/8" MOLDED & 1/4" THICK

PREDRILLED

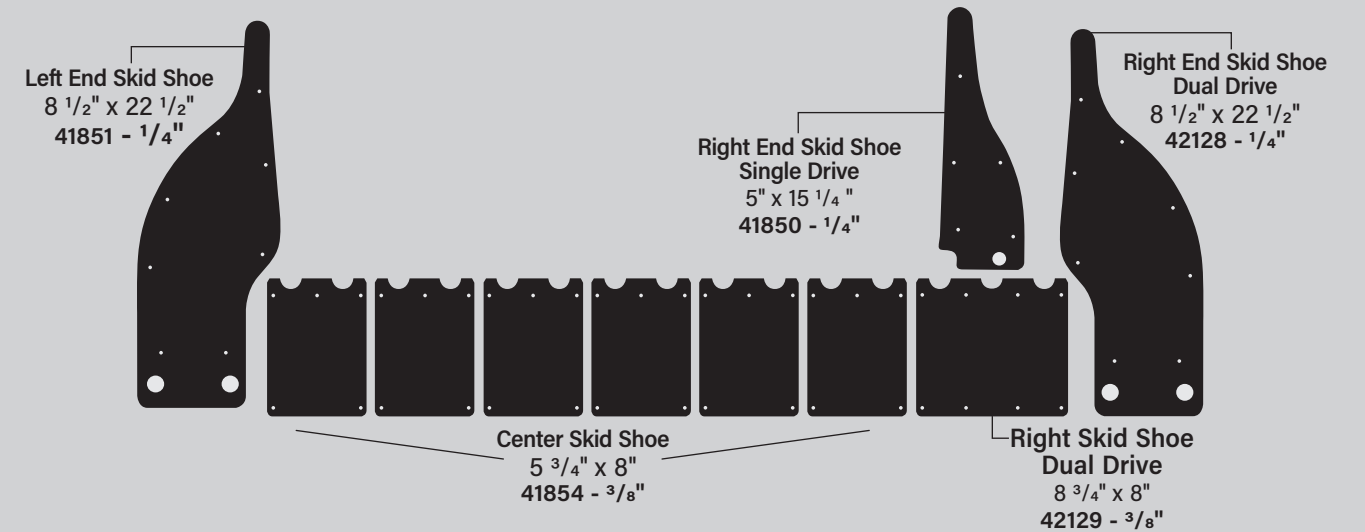

LEFT

View from Operator's Position
(Looking Down Onto Head)

RIGHT

KITS FOR NEW HOLLAND 740CF SERIES - 3/8" MOLDED & 1/4" THICK

SET SIZE	SHOE THICKNESS	PD*	PART NO BLACK DUAL DRIVE	PART NO BLACK SINGLE DRIVE	RETAIL PRICE
35 ft	3/8" Molded Centers & 1/4" Ends	PD	83558	83314	\$ 880 set
30 ft	3/8" Molded Centers & 1/4" Ends	PD	83559	83315	\$ 769 set
25 ft	3/8" Molded Centers & 1/4" Ends	PD	83560	83316	\$ 659 set
20 ft	3/8" Molded Centers & 1/4" Ends	PD	83561	83317	\$ 549 set

NOTE: Center Skid Shoes are 3/8" thick molded. End Skid Shoes are 1/4" thick and are not molded.

REPLACEMENT PARTS FOR NEW HOLLAND 740CF SERIES - 3/8" MOLDED & 1/4" THICK

DESCRIPTION	SHOE THICKNESS	SIZE	PD*	PART NO BLACK DUAL DRIVE	PART NO BLACK SINGLE DRIVE	RETAIL PRICE
Right End Skid Shoe	1/4"	5" x 15 1/4"	PD	-	41850	\$ 45 ea
Right End Skid Shoe	1/4"	8 1/2" x 22 1/2"	PD	42128	-	\$ 61 ea
Right Skid Shoe	3/8" Molded	8 3/4" x 8"	PD	42129	-	\$ 32 ea
Left Skid Shoe	1/4"	8 1/2" x 22 1/2"	PD	41851	41851	\$ 61 ea
Center Skid Shoe	3/8" Molded	5 3/4" x 8"	PD	41854	41854	\$ 21 ea

*PD = Predrilled
Hardware included = Size 86 Small Head Pop Rivets. Extra rivets can be purchased on page 149.



PREMIUM POLY SKID SHOES - HARDWARE INCLUDED

SKID SHOES FOR NEW HOLLAND 74C SERIES
 PIN: PNL018301 & LATER, Y9ZL & YAZL - 1/4" THICK

PREDRILLED

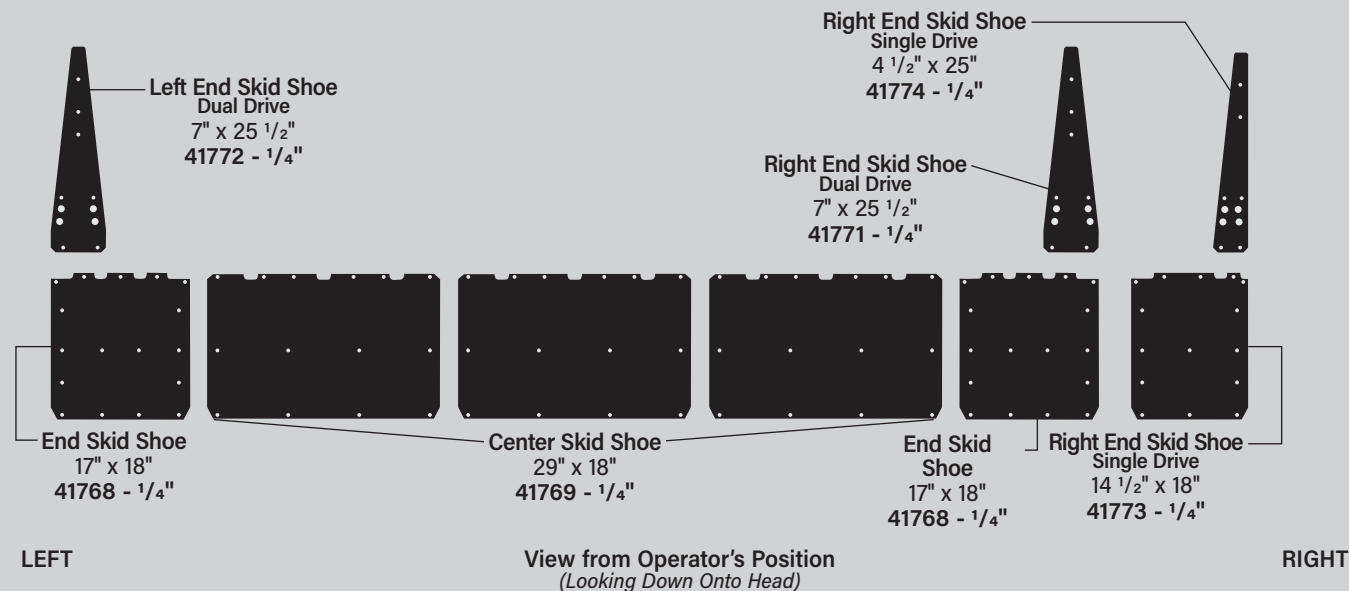

KITS FOR NEW HOLLAND 74C SERIES - PIN: PNL018301 & LATER - 1/4" THICK

SET SIZE	SHOE THICKNESS	PD*	PART NO BLACK DUAL DRIVE	PART NO BLACK SINGLE DRIVE	RETAIL PRICE
35 ft	1/4"	PD	82918	-	\$ 1417 set
30 ft	1/4"	PD	82919	-	\$ 1216 set
25 ft	1/4"	PD	82920	82922	\$ 1028 set
20 ft	1/4"	PD	82921	82923	\$ 834 set

REPLACEMENT PARTS FOR NEW HOLLAND 74C SERIES - PIN: PNL018301 & LATER - 1/4" THICK

DESCRIPTION	SHOE THICKNESS	SIZE	PD*	PART NO BLACK DUAL DRIVE	PART NO BLACK SINGLE DRIVE	RETAIL PRICE
End Skid Shoe	1/4"	17" x 18"	PD	41768	41768	\$ 99 ea
Center Skid Shoe	1/4"	29" x 18"	PD	41769	41769	\$ 113 ea
Right End Skid Shoe	1/4"	14 1/2" x 18"	PD	-	41773	\$ 93 ea
Right End Skid Shoe	1/4"	4 1/2" x 25"	PD	-	41774	\$ 52 ea
Right End Skid Shoe	1/4"	7" x 25 1/2"	PD	41771	-	\$ 65 ea
Left End Skid Shoe	1/4"	7" x 25 1/2"	PD	41772	-	\$ 65 ea

*PD = Predrilled
 Hardware included = Size 86 Small Head Pop Rivets. Extra rivets can be purchased on page 149.



PREMIUM POLY SKID SHOES - HARDWARE INCLUDED

SKID SHOES FOR NEW HOLLAND 74C SERIES
 PIN: PNL017801 - PNL018300 - 1/4" THICK

PREDRILLED

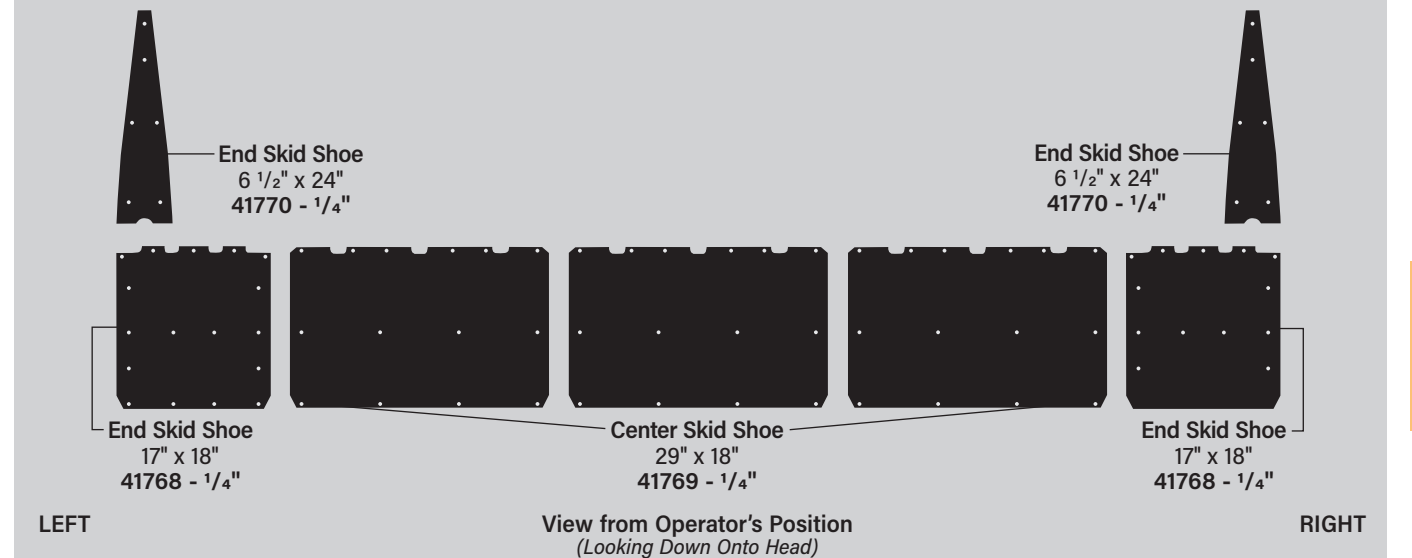

KITS FOR NEW HOLLAND 74C SERIES - PIN: PNL017801 - PNL018300 - 1/4" THICK

SET SIZE	SHOE THICKNESS	PD*	PART NO BLACK	RETAIL PRICE
30 ft	1/4"	PD	82915	\$ 1216 set
25 ft	1/4"	PD	82916	\$ 1028 set
20 ft	1/4"	PD	82917	\$ 834 set

REPLACEMENT PARTS FOR NEW HOLLAND 74C SERIES - PIN: PNL017801 - PNL018300 - 1/4" THICK

DESCRIPTION	SHOE THICKNESS	PD*	SIZE	PART NO BLACK	RETAIL PRICE
End Skid Shoe	1/4"	PD	17" x 18"	41768	\$ 99 ea
Center Skid Shoe	1/4"	PD	29" x 18"	41769	\$ 113 ea
End Shoe	1/4"	PD	6 1/2" x 24"	41770	\$ 57 ea

*PD = Predrilled
 Hardware included = Size 86 Small Head Pop Rivets. Extra rivets can be purchased on page 149.

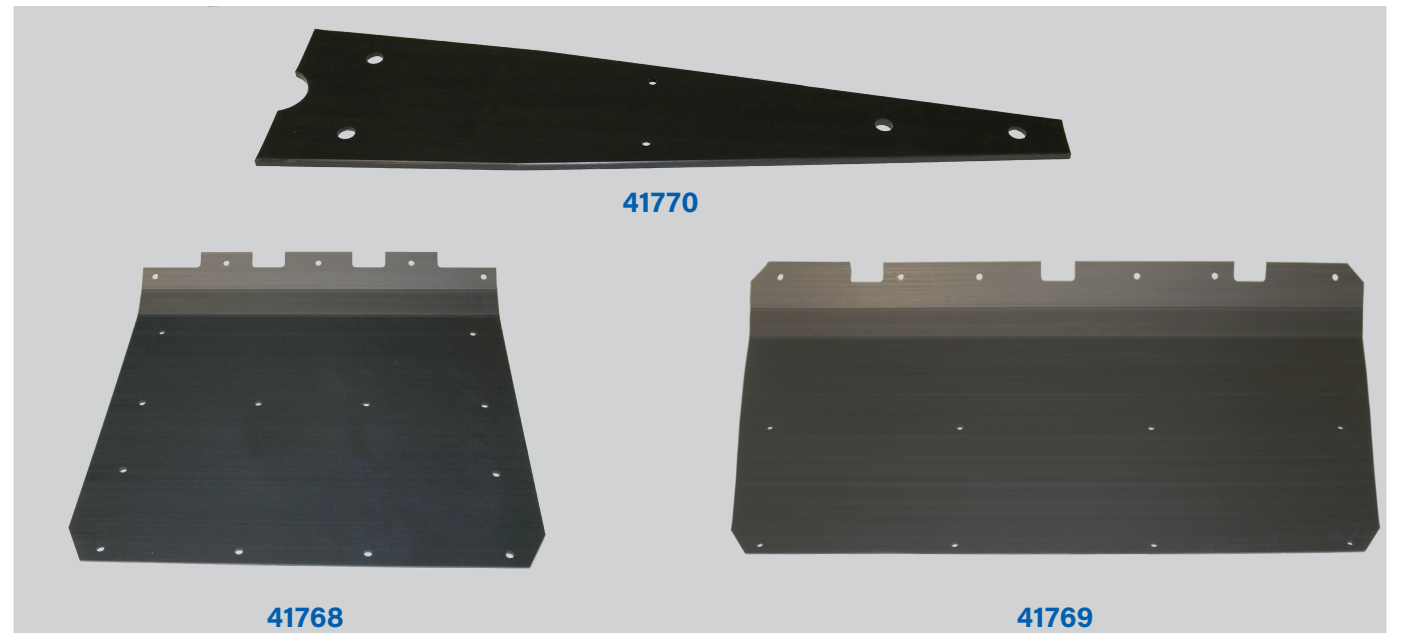

PREMIUM POLY SKID SHOES - HARDWARE INCLUDED

SKID SHOES FOR NEW HOLLAND 74C SERIES
PIN: PNL017183 - PNL017800 - 1/4" THICK

PREDRILLED

Right End Skid Shoe
Single Drive
4 1/2" x 30"
41176 - 1/4"

End Skid Shoe
Dual Drive
7" x 30"
41177 - 1/4"

End Skid Shoe
Dual Drive
7" x 30"
41177 - 1/4"

End Skid Shoe
23" x 21"
41766 - 1/4"

Center Skid Shoe
29" x 21"
41767 - 1/4"

End Skid Shoe
23" x 21"
41766 - 1/4"

LEFT

View from Operator's Position
(Looking Down Onto Head)

RIGHT

KITS FOR NEW HOLLAND 74C SERIES - PIN: PNL017183 - PNL017800 - 1/4" THICK

SET SIZE	SHOE THICKNESS	PD*	PART NO BLACK	RETAIL PRICE
30 ft	1/4"	PD	82911	\$ 1211 set
25 ft	1/4"	PD	82912	\$ 1028 set
20 ft	1/4"	PD	82913	\$ 834 set

REPLACEMENT PARTS FOR NEW HOLLAND 74C SERIES - PIN: PNL017183 - PNL017800 - 1/4" THICK

DESCRIPTION	SHOE THICKNESS	PD*	SIZE	PART NO BLACK	RETAIL PRICE
End Skid Shoe	1/4"	PD	23" x 21"	41766	\$ 97 ea
Center Skid Shoe	1/4"	PD	29" x 21"	41767	\$ 113 ea
End Skid Shoe Dual Drive	1/4"	PD	7" x 30"	41177	\$ 66 ea
Right End Skid Shoe Single Drive	1/4"	PD	4 1/2" x 30"	41176	\$ 51 ea

*PD = Predrilled
Hardware included = Size 86 Small Head Pop Rivets. Extra rivets can be purchased on page 149.

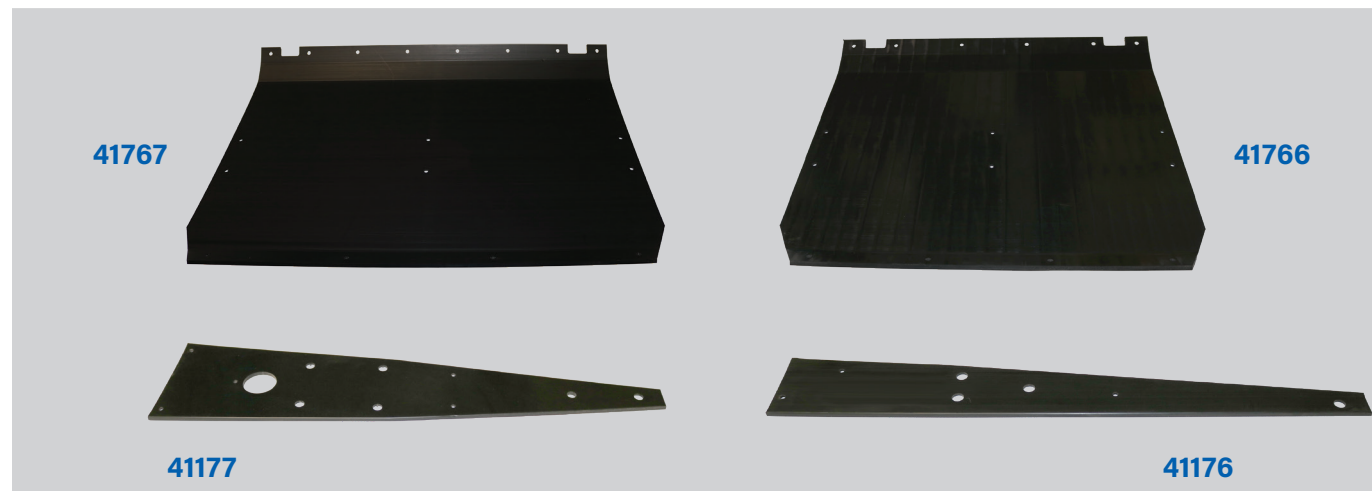

PREMIUM POLY SKID SHOES - HARDWARE INCLUDED

SKID SHOES FOR NEW HOLLAND 74C SERIES
PIN: BEFORE PNL017183 INCLUDING ALL HAJ PIN'S - 1/4" THICK

PREDRILLED

Right End Skid Shoe
Single Drive
4 1/2" x 30"
41176 - 1/4"

End Skid Shoe
Dual Drive
7" x 30"
41177 - 1/4"

End Skid Shoe
23" x 24"
40885 - 1/4"

Center Skid Shoe
29" x 24"
40884 - 1/4"

End Skid Shoe
23" x 24"
40885 - 1/4"

LEFT

View from Operator's Position
(Looking Down Onto Head)

RIGHT

KITS FOR NEW HOLLAND 74C SERIES - PIN: BEFORE PNL017183 INCLUDING ALL HAJ PIN'S - 1/4" THICK

SET SIZE	SHOE THICKNESS	PD*	PART NO BLACK	RETAIL PRICE
30 ft	1/4"	PD	82179	\$ 1211 set
25 ft	1/4"	PD	82180	\$ 1028 set
20 ft	1/4"	PD	82183	\$ 835 set

REPLACEMENT PARTS FOR NEW HOLLAND 74C SERIES - PIN: BEFORE PNL017183 INCLUDING ALL HAJ PIN'S - 1/4" THICK

DESCRIPTION	SHOE THICKNESS	PD*	SIZE	PART NO BLACK	RETAIL PRICE
End Skid Shoe	1/4"	PD	23" x 24"	40885	\$ 99 ea
Center Skid Shoe	1/4"	PD	29" x 24"	40884	\$ 113 ea
End Skid Shoe Dual Drive	1/4"	PD	7" x 30"	41177	\$ 66 ea
Right End Skid Shoe Single Drive	1/4"	PD	4 1/2" x 30"	41176	\$ 51 ea

*PD = Predrilled
Hardware included = Size 86 Small Head Pop Rivets. Extra rivets can be purchased on page 149.



PREMIUM POLY SKID SHOES - HARDWARE INCLUDED

SKID SHOES FOR NEW HOLLAND 973 /73C SERIES - 1/4" THICK

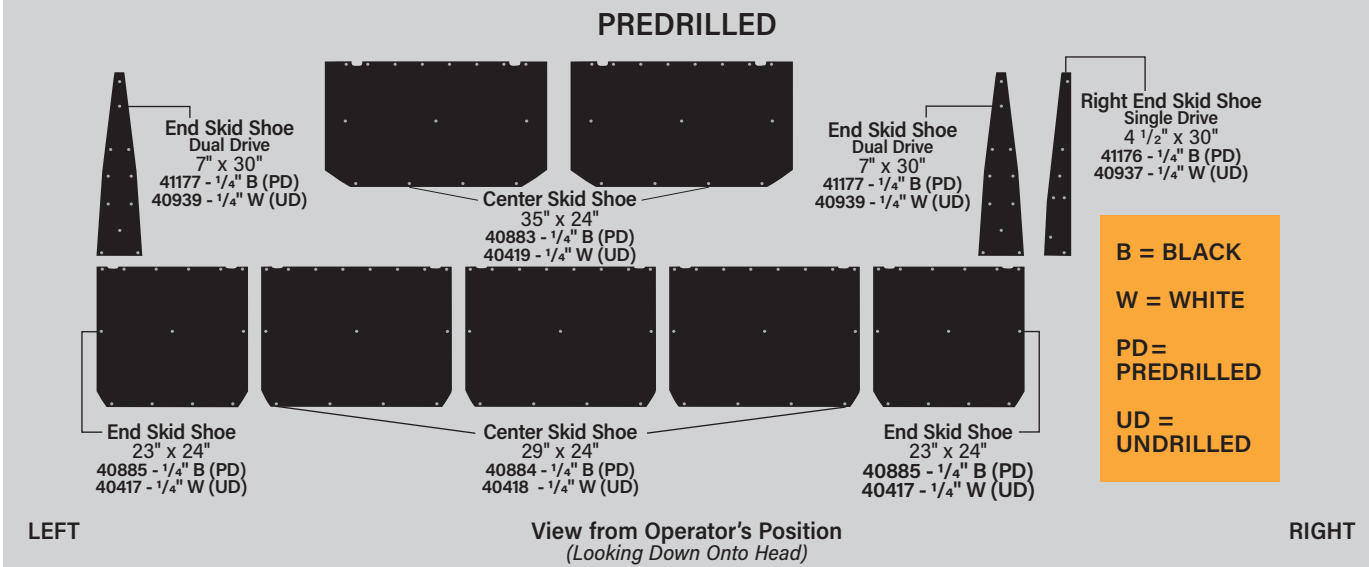

KITS FOR NEW HOLLAND 973 /73C SERIES - 1/4" THICK

SET SIZE	SHOE THICKNESS	PD*/UD**	PART NO - BLACK	PART NO - WHITE	RETAIL PRICE
30 ft	1/4"	PD	82179	80257	\$ 1211 set
	1/4"	UD	—	80258	\$ 1036 set
25 ft	1/4"	PD	82180	80255	\$ 1028 set
	1/4"	UD	—	80256	\$ 887 set
24 ft	1/4"	PD	82181	80253	\$ 995 set
	1/4"	UD	—	80254	\$ 854 set
22 ft	1/4"	PD	82182	80251	\$ 915 set
	1/4"	UD	—	80252	\$ 789 set
20 ft	1/4"	PD	82183	80249	\$ 835 set
	1/4"	UD	—	80250	\$ 716 set
18 ft	1/4"	PD	82184	80247	\$ 762 set
	1/4"	UD	—	80248	\$ 655 set
16 ft	1/4"	PD	82185	80984	\$ 668 set
	1/4"	UD	—	80246	\$ 582 set
15 ft	1/4"	PD	82186	80244	\$ 638 set
	1/4"	UD	—	80245	\$ 542 set
13 ft	1/4"	PD	82187	80242	\$ 555 set
	1/4"	UD	—	80243	\$ 479 set

REPLACEMENT PARTS FOR NEW HOLLAND 973 /73C SERIES - 1/4" THICK

DESCRIPTION	SHOE THICKNESS	PD*/UD**	PART NO - BLACK	PART NO - WHITE	RETAIL PRICE
35" x 24"	1/4"	PD	40883	40419	\$ 136 ea
Center Skid Shoe	1/4"	UD	—	40428	\$ 123 ea
29" x 24"	1/4"	PD	40884	40418	\$ 113 ea
Center Skid Shoe	1/4"	UD	—	40427	\$ 103 ea
23" x 24"	1/4"	PD	40885	40417	\$ 99 ea
End Skid Shoe	1/4"	UD	—	40426	\$ 89 ea
4 1/2" x 30"	1/4"	PD	41176	40937	\$ 51 ea
Single Drive	1/4"	UD	—	—	—
7" x 30"	1/4"	PD	41177	40939	\$ 66 ea
Dual Drive	1/4"	UD	—	—	—

*PD = Predrilled, **UD = Undrilled Hardware included = 86 Small Head Pop Rivets. Extra rivets can be purchased on page 149.

PREMIUM POLY SKID SHOES - HARDWARE INCLUDED

SKID SHOES FOR NEW HOLLAND 880CF /840CD SERIES DRAPER 3/8" MOLDED & 1/4" THICK

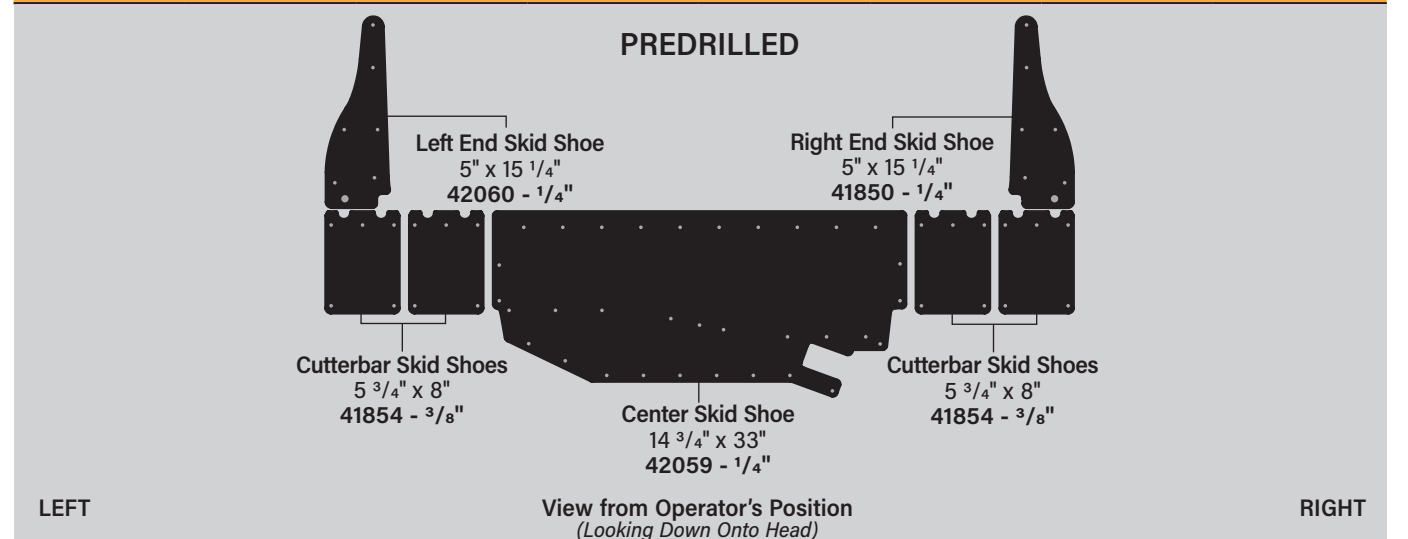

KITS FOR NEW HOLLAND 880CF /840CD SERIES DRAPER - 3/8" MOLDED & 1/4" THICK

SET SIZE	SHOE THICKNESS	PD*	PART NO - BLACK	RETAIL PRICE
45 ft	3/8" Molded Cutterbars & 1/4" Center/Ends	PD	83476	\$ 1273 set
40 ft	3/8" Molded Cutterbars & 1/4" Center/Ends	PD	83475	\$ 1108 set
35 ft	3/8" Molded Cutterbars & 1/4" Center/Ends	PD	83474	\$ 964 set
30 ft	3/8" Molded Cutterbars & 1/4" Center/Ends	PD	83473	\$ 812 set
25 ft	3/8" Molded Cutterbars & 1/4" Center/Ends	PD	83470	\$ 690 set

NOTE: Cutterbar Skid Shoes are 3/8" thick molded. Both Center and End Shoes are 1/4" thick and not molded.

REPLACEMENT PARTS FOR NEW HOLLAND 880CF /840CD SERIES DRAPER - 3/8" MOLDED & 1/4" THICK

DESCRIPTION	SHOE THICKNESS	PD*	SIZE	PART NO - BLACK	RETAIL PRICE
Left End Skid Shoe	1/4"	PD	5" x 15 1/4"	42060	\$ 45 ea
Right End Skid Shoe	1/4"	PD	5" x 15 1/4"	41850	\$ 45 ea
Center Skid Shoe	1/4"	PD	14 3/4" x 33"	42059	\$ 139 ea
Cutterbar Skid Shoe	3/8" Molded	PD	5 3/4" x 8"	41854	\$ 21 ea

*PD = Predrilled Hardware included = 86 Small Head Pop Rivets. Extra rivets can be purchased on page 149. Part 42059 (Center Skid Shoe) uses M6 Bolts.

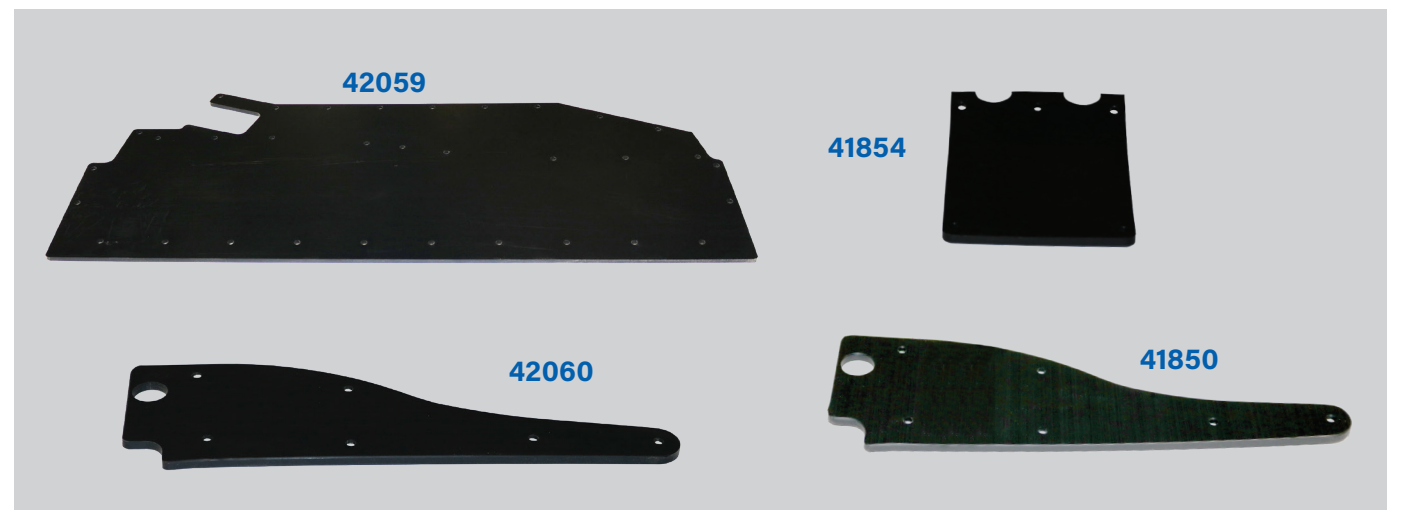

PREMIUM POLY SKID SHOES - HARDWARE INCLUDED

SKID SHOES FOR NEW HOLLAND 86C /83C /82C SERIES DRAPER - 3/8" THICK

THICKER than OEM

PREDRILLED

HEAD WIDTH	QUANTITY
30'	60
35'	70
40'	80
45'	90



Cutterbar Skid Shoe - 6" x 6.5"
22723/83840 - 3/8"
(Order separately - NOT INCLUDED in kits)

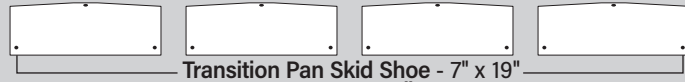

Transition Pan Skid Shoe - 7" x 19"
42061 - 3/8"
(Order separately - NOT INCLUDED in kits)

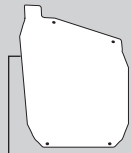

Left End Skid Shoe
11" x 15"
42054 - 3/8"



Center Skid Shoe
14" x 16"
42053 - 3/8"

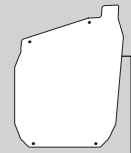

Right End Skid Shoe
11" x 15"
42055 - 3/8"



Center Skid Shoe Assembly
14" x 16"
42319 - 3/8"
(Order Separately - NOT INCLUDED in Kits)

ORDER SEPARATELY - NOT INCLUDED IN KITS
DUE TO LARGE SIZE, ADDITIONAL SHIPPING FEE MAY APPLY



View from Operator's Position
(Looking Down Onto Head)

Draper Skid Plate
35 3/16" x 76 5/8"
42299 - 1/4"
(Order Separately - NOT INCLUDED in Kits)

LEFT

RIGHT

KITS FOR NEW HOLLAND 86C /83C /82C SERIES DRAPER - 3/8" THICK

SET SIZE	SHOE THICKNESS	PD*	PART NO - BLACK	RETAIL PRICE
45 ft	3/8" Centers & Ends	PD	83490	\$ 360 set
40 ft	3/8" Centers & Ends	PD	83490	\$ 360 set
35 ft	3/8" Centers & Ends	PD	83490	\$ 360 set
30 ft	3/8" Centers & Ends	PD	83490	\$ 360 set

REPLACEMENT PARTS FOR NEW HOLLAND 86C /83C /82C SERIES DRAPER - 3/8" THICK

DESCRIPTION	SHOE THICKNESS	PD*	SIZE	PART NO - BLACK	RETAIL PRICE
Left End Skid Shoe	3/8"	PD	11" x 15"	42054	\$ 63 ea
Right End Skid Shoe	3/8"	PD	11" x 15"	42055	\$ 63 ea
Center Skid Shoe	3/8"	PD	14" x 16"	42053	\$ 65 ea
Transition Pan Skid Shoe	3/8"	PD	7" x 19"	42061	\$ 47 ea
Center Skid Assembly <small>Sold Separately. Includes Metal Skid Plate, Poly Skid Shoe & Hardware.</small>	3/8"	PD	14" x 16"	42319	\$ 196 ea
Draper Skid Plate <small>Sold Separately</small>	1/4"	PD	35 3/16" x 76 5/8"	42299	\$ 347 ea
Cutterbar Skid Shoe	3/8" Molded	PD	6" x 6 1/2"	22723	\$ 12 ea
<small>Sold Separately. Hardware not included. Reuse OEM hardware.</small>					
Cutterbar Skid Shoe - 10pk <small>Sold Separately. Hardware not included. Reuse OEM hardware.</small>	3/8" Molded	PD	6" x 6 1/2"	83840	\$ 109 pk

*PD = Predrilled Hardware included = Nuts & Bolts

Center Skid Shoe Assembly

14" x 16"
3/8" Thickness
42319 \$ 196

Includes Metal Skid Plate, Poly Skid Shoe & Mounting Hardware

Reuse your Factory OEM Mount Brackets for Installation

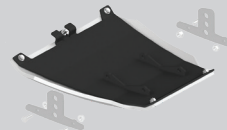

Questions? Scan the code to learn more.



PREMIUM POLY SKID SHOES - HARDWARE INCLUDED

SKID SHOES FOR NEW HOLLAND 84C SERIES DRAPER AFTER SERIAL #PPP001119 - 3/8" THICK

THICKER than OEM

PREDRILLED

HEAD WIDTH	QUANTITY
30'	60
35'	70
40'	80
45'	90

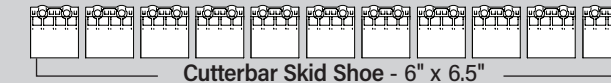

Cutterbar Skid Shoe - 6" x 6.5"
22723/83840 - 3/8"
(Order separately - NOT INCLUDED in kits)

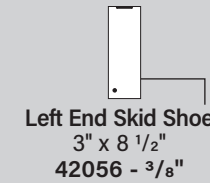

Left End Skid Shoe
3" x 8 1/2"
42056 - 3/8"

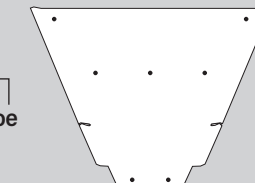

Center Skid Shoe
17 1/4" x 23"
41567 - 3/8"

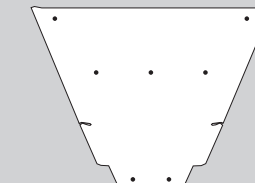

Right End Skid Shoe
3" x 8 1/2"
42057 - 3/8"

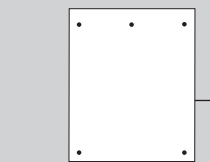

Outer Skid Shoe
11 3/4" x 15"
41566 - 3/8"

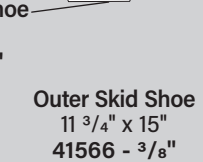

Outer Skid Shoe
11 3/4" x 15"
41566 - 3/8"

LEFT

View from Operator's Position
(Looking Down Onto Head)

RIGHT

KITS FOR NEW HOLLAND 84C SERIES DRAPER - AFTER SERIAL #PPP001119 - 3/8" THICK

SET SIZE	SHOE THICKNESS	PD*	PART NO - WHITE	RETAIL PRICE
36 ft	3/8"	PD	83502	\$ 551 set
30 ft	3/8"	PD	83502	\$ 551 set

REPLACEMENT PARTS FOR NEW HOLLAND 84C SERIES DRAPER - AFTER SERIAL #PPP001119 - 3/8" THICK

DESCRIPTION	SHOE THICKNESS	PD*	SIZE	PART NO - WHITE	RETAIL PRICE
Left End Skid Shoe	3/8"	PD	3" x 8 1/2"	42056	\$ 29 ea
Right End Skid Shoe	3/8"	PD	3" x 8 1/2"	42057	\$ 29 ea
Center Skid Shoe	3/8"	PD	17 1/4" x 23"	41567	\$ 83 ea
Outer Skid Shoe	3/8"	PD	11 1/4" x 15"	41566	\$ 40 ea
Cutterbar Skid Shoe	3/8" Molded	PD	6" x 6 1/2"	22723	\$ 12 ea
<small>Sold Separately. Hardware not included. Reuse OEM hardware.</small>					
Cutterbar Skid Shoe - 10pk <small>Sold Separately. Hardware not included. Reuse OEM hardware.</small>	3/8" Molded	PD	6" x 6 1/2"	83840	\$ 109 pk

*PD = Predrilled Hardware included = Nuts & Bolts
Part 41567 (Center Skid Shoe) uses 68 Small Head Pop Rivets. Extra rivets can be purchased on page 149.



SKID SHOES



PREMIUM POLY SKID SHOES - HARDWARE INCLUDED

SKID SHOES FOR NEW HOLLAND 84C SERIES DRAPER - BEFORE SERIAL #PPP001119 - 3/8" THICK

PREDRILLED

THICKER than OEM

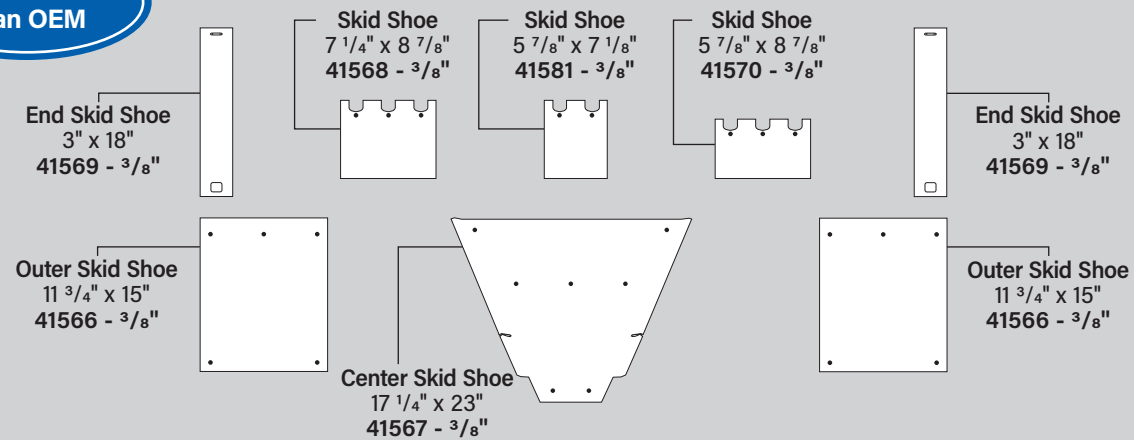

LEFT

View from Operator's Position
(Looking Down Onto Head)

RIGHT

KITS FOR NEW HOLLAND 84C SERIES DRAPER - BEFORE SERIAL #PPP001119 - 3/8" THICK

SET SIZE	SHOE THICKNESS	PD*	PART NO - WHITE	RETAIL PRICE
36 ft	3/8"	PD	82576	\$ 1360 set
30 ft	3/8"	PD	82577	\$ 1185 set

REPLACEMENT PARTS FOR NEW HOLLAND 84C SERIES DRAPER - BEFORE SERIAL #PPP001119 - 3/8" THICK

DESCRIPTION	SHOE THICKNESS	PD*	SIZE	PART NO - WHITE	RETAIL PRICE
End Skid Shoe	3/8"	PD	3" x 18"	41569	\$ 43 ea
Outer Skid Shoe	3/8"	PD	11 3/4" x 15"	41566	\$ 40 ea
Center Skid Shoe	3/8"	PD	17 1/4" x 23"	41567	\$ 83 ea
Skid Shoe	3/8"	PD	7 1/4" x 8 7/8"	41568	\$ 31 ea
Skid Shoe	3/8"	PD	5 7/8" x 7 1/8"	41581	\$ 29 ea
Skid Shoe	3/8"	PD	5 7/8" x 8 7/8"	41570	\$ 29 ea

*PD = Predrilled
Hardware included = Nuts & Bolts
Parts 41567, 41568, 41581 and 41570 use 68 Small Head Pop Rivets. Extra rivets can be purchased on page 149.

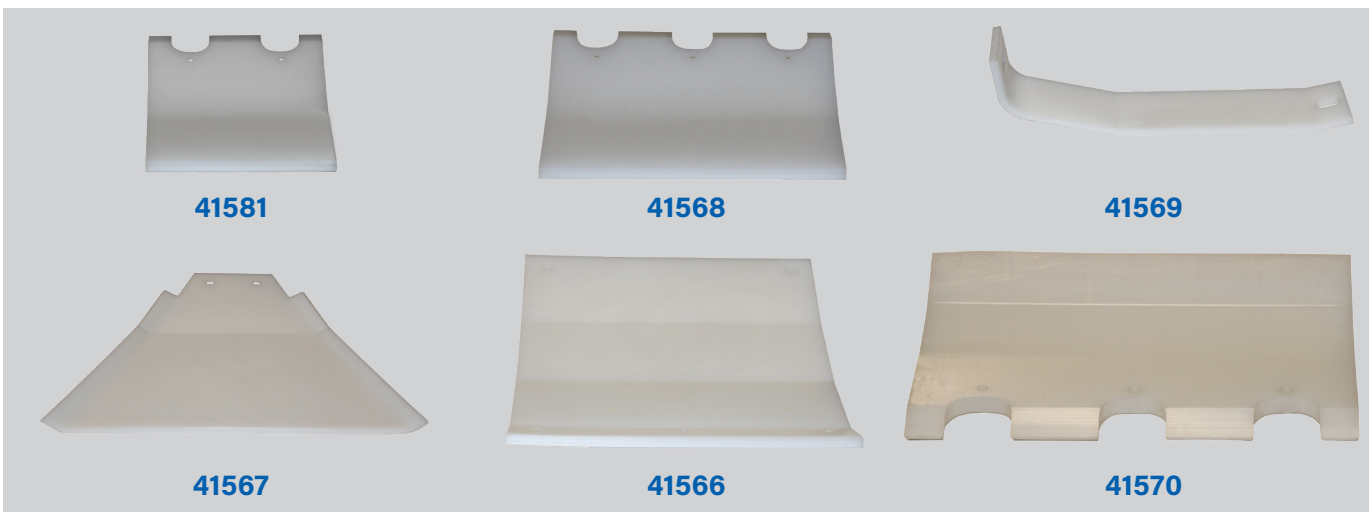

PREMIUM POLY SKID SHOES - HARDWARE INCLUDED

SKID SHOES FOR JOHN DEERE 600F SERIES - 3/8" & 1/4" THICK

PREDRILLED

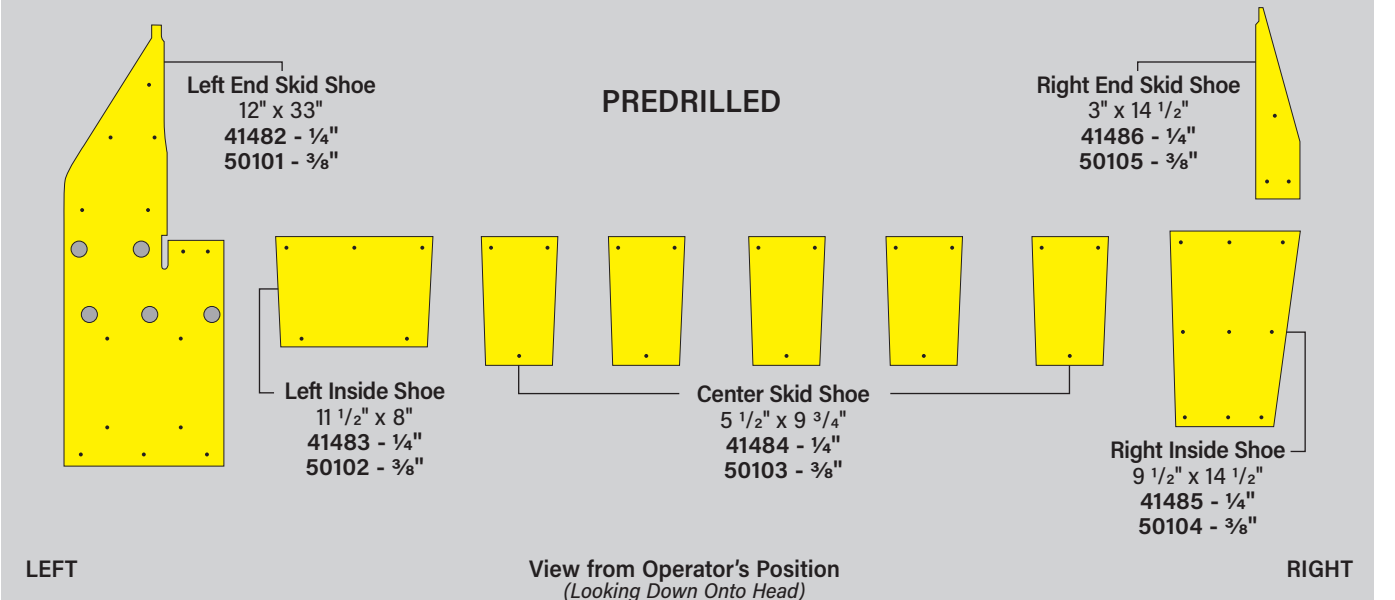

LEFT

View from Operator's Position
(Looking Down Onto Head)

RIGHT

KITS FOR JOHN DEERE 600F SERIES - 3/8" & 1/4" THICK

SET SIZE	SHOE THICKNESS	PD*	PART NO - YELLOW	RETAIL PRICE	SET SIZE	SHOE THICKNESS	PD*	PART NO - YELLOW	RETAIL PRICE
35 ft	3/8"	PD	90069	\$ 931 set	22 ft	3/8"	PD	90074	\$ 625 set
	1/4"	PD	82465	\$ 733 set		1/4"	PD	83310	\$ 482 set
30 ft	3/8"	PD	90070	\$ 812 set	20 ft	3/8"	PD	90072	\$ 566 set
	1/4"	PD	82466	\$ 623 set		1/4"	PD	82468	\$ 442 set
25 ft	3/8"	PD	90071	\$ 692 set	18 ft	3/8"	PD	90073	\$ 515 set
	1/4"	PD	82467	\$ 531 set		1/4"	PD	82641	\$ 416 set

REPLACEMENT PARTS FOR JOHN DEERE 600F SERIES - 3/8" & 1/4" THICK

DESCRIPTION	SIZE	SHOE THICKNESS	PD*	PART NO - YELLOW	RETAIL PRICE
Left End Skid Shoe	12" x 33"	3/8"	PD	50101	\$ 84 ea
	12" x 33"	1/4"	PD	41482	\$ 61 ea
Left Inside Shoe	11 1/2" x 8"	3/8"	PD	50102	\$ 27 ea
	11 1/2" x 8"	1/4"	PD	41483	\$ 20 ea
Center Skid Shoe	5 1/2" x 9 3/4"	3/8"	PD	50103	\$ 18 ea
	5 1/2" x 9 3/4"	1/4"	PD	41484	\$ 15 ea
Right Inside Shoe	9 1/2" x 14 1/2"	3/8"	PD	50104	\$ 30 ea
	9 1/2" x 14 1/2"	1/4"	PD	41485	\$ 25 ea
Right End Skid Shoe	3" x 14 1/2"	3/8"	PD	50105	\$ 18 ea
	3" x 14 1/2"	1/4"	PD	41486	\$ 15 ea

*PD = Predrilled
Hardware included = Size 88 Small Head Pop Rivets. Extra rivets can be purchased on page 149.

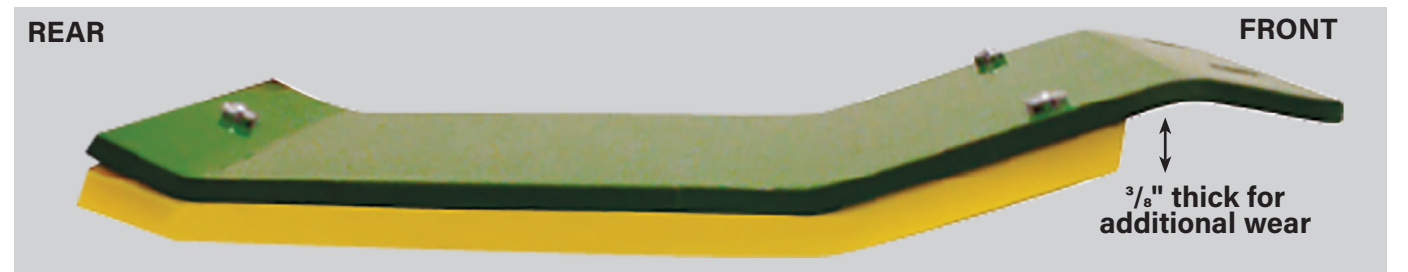



PREMIUM POLY SKID SHOES - HARDWARE INCLUDED

SKID SHOES FOR JOHN DEERE 600F RAISED CUT SERIES - 3/8" & 1/4" THICK

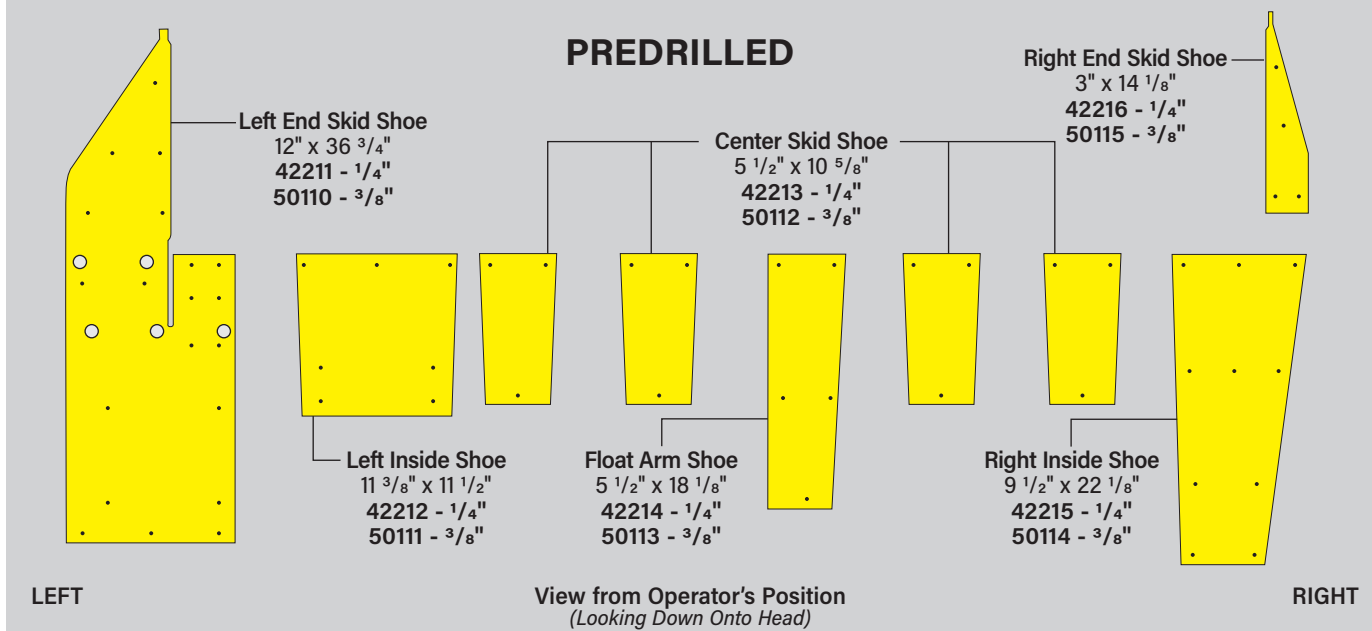

KITS FOR JOHN DEERE 600F RAISED CUT - 3/8" & 1/4" THICK

SET SIZE	SHOE THICKNESS	PD*	PART NO - YELLOW	RETAIL PRICE	SET SIZE	SHOE THICKNESS	PD*	PART NO - YELLOW	RETAIL PRICE
35 ft	3/8"	PD	90081	\$ 1131 set	22 ft	3/8"	PD	90078	\$ 780 set
	1/4"	PD	83584	\$ 931 set		1/4"	PD	83581	\$ 631 set
30 ft	3/8"	PD	90080	\$ 1005 set	20 ft	3/8"	PD	90077	\$ 721 set
	1/4"	PD	83583	\$ 815 set		1/4"	PD	83580	\$ 587 set
25 ft	3/8"	PD	90079	\$ 865 set					
	1/4"	PD	83582	\$ 698 set					

REPLACEMENT PARTS FOR JOHN DEERE 600F RAISED CUT - 3/8" & 1/4" THICK

DESCRIPTION	SIZE	SHOE THICKNESS	PD*	PART NO - YELLOW	RETAIL PRICE
Left End Skid Shoe	12" x 36 3/4"	3/8"	PD	50110	\$ 109 ea
	12" x 36 3/4"	1/4"	PD	42211	\$ 85 ea
Left Inside Shoe	11 3/8" x 11 1/2"	3/8"	PD	50111	\$ 39 ea
	11 3/8" x 11 1/2"	1/4"	PD	42212	\$ 30 ea
Center Skid Shoe	5 1/2" x 10 5/8"	3/8"	PD	50112	\$ 21 ea
	5 1/2" x 10 5/8"	1/4"	PD	42213	\$ 17 ea
Float Arm Shoe	5 1/2" x 18 1/8"	3/8"	PD	50113	\$ 29 ea
	5 1/2" x 18 1/8"	1/4"	PD	42214	\$ 22 ea
Right Inside Shoe	9 1/2" x 22 1/8"	3/8"	PD	50114	\$ 49 ea
	9 1/2" x 22 1/8"	1/4"	PD	42215	\$ 32 ea
Right End Skid Shoe	3" x 14 1/8"	3/8"	PD	50115	\$ 34 ea
	3" x 14 1/8"	1/4"	PD	42216	\$ 37 ea

*PD = Predrilled
Hardware included = Size 88 Small Head Pop Rivets. Extra rivets can be purchased on page 149.

DRAW BAR SAVERS

REDUCE FRICTION AND SAVE COMPONENT WEAR

UHMW Draw Bar Savers for your drawbars and hitches have slick properties for durability and wear resistance. Stacking may be used to achieve the desired thickness for your application.

FIND THEM ON PAGE 39



PREMIUM POLY SKID SHOES - HARDWARE INCLUDED

SKID SHOES FOR JOHN DEERE 900F SERIES - 3/8" & 1/4" THICK

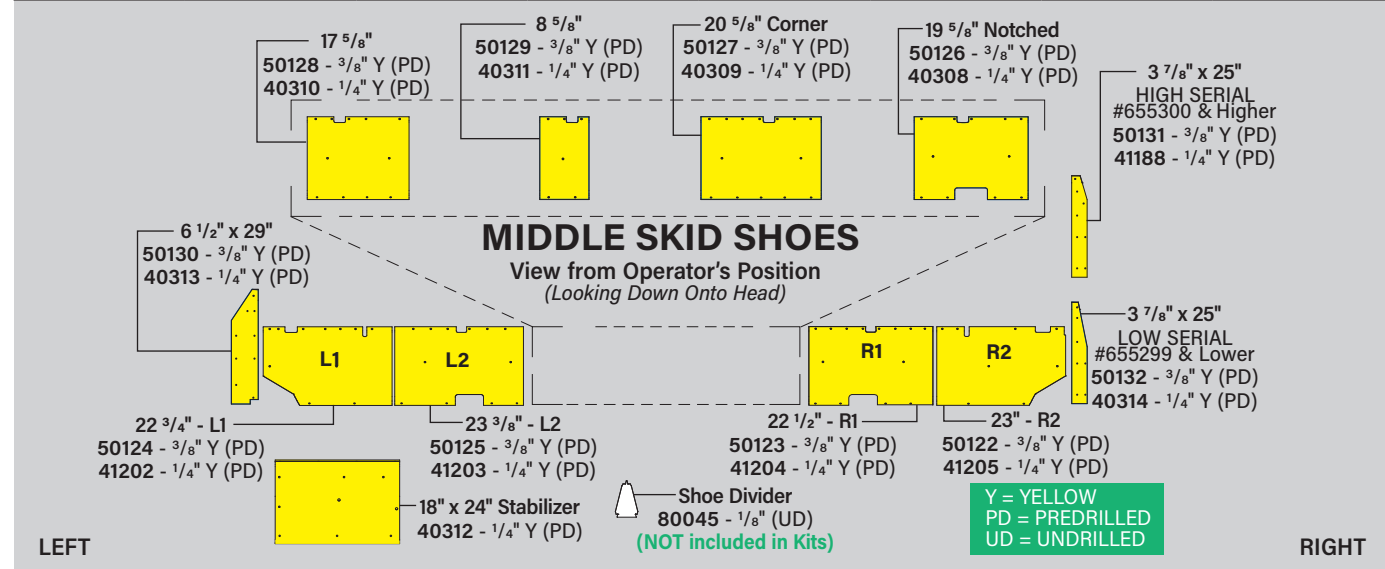

KITS FOR JOHN DEERE 900F SERIES - 3/8" & 1/4" THICK

SET SIZE	SHOE THICKNESS	PD*	PART NO - YELLOW	RETAIL PRICE	SET SIZE	SHOE THICKNESS	PD*	PART NO - YELLOW	RETAIL PRICE
30 ft	3/8"	PD	90100	\$ 1442 set	20 ft	3/8"	PD	90105	\$ 1113 set
	1/4"	PD	80040	\$ 1028 set		1/4"	PD	80024	\$ 866 set
25 ft	3/8"	PD	90101	\$ 1319 set	18 ft	3/8"	PD	90106	\$ 1007 set
	1/4"	PD	80036	\$ 924 set		1/4"	PD	80020	\$ 839 set
24 ft	3/8"	PD	90102	\$ 1234 set	15 ft	3/8"	PD	90108	\$ 947 set
	1/4"	PD	80552	\$ 920 set		1/4"	PD	80016	\$ 587 set
22 ft	3/8"	PD	90103	\$ 1139 set	13 ft	3/8"	PD	90110	\$ 855 set
	1/4"	PD	80171	\$ 781 set		1/4"	PD	81066	\$ 758 set

REPLACEMENT PARTS FOR JOHN DEERE 900F SERIES - 3/8" & 1/4" THICK

DESCRIPTION	SHOE THICKNESS	PD*	PART NO YELLOW	RETAIL PRICE	DESCRIPTION	SHOE THICKNESS	PD*	PART NO YELLOW	RETAIL PRICE
*Left End Kit (L1) & (L2)	3/8"	PD	50120	\$ 204 ea	Corner Cut 20 5/8" x 16 1/2"	3/8"	PD	50127	\$ 102 ea
	1/4"	PD	41254	\$ 146 ea	Middle 17 5/8" x 16 1/2"	1/4"	PD	40309	\$ 72 ea
*Right End Kit (R1) & (R2)	3/8"	PD	50121	\$ 204 ea	Middle 8 5/8" x 16 1/2"	3/8"	PD	50128	\$ 102 ea
	1/4"	PD	41259	\$ 146 ea	Middle 23" x 16 1/2"	1/4"	PD	40310	\$ 63 ea
Right Outside (R2) 23" x 16 1/2"	3/8"	PD	50122	\$ 108 ea	Middle 6 1/2" x 29"	3/8"	PD	50129	\$ 58 ea
	1/4"	PD	41205	\$ 77 ea	End Shoe - Left 22 1/2" x 16 1/2"	1/4"	PD	40311	\$ 38 ea
Right Inside (R1) 22 1/2" x 16 1/2"	3/8"	PD	50123	\$ 108 ea	End Shoe - Left 6 1/2" x 29"	3/8"	PD	50130	\$ 57 ea
	1/4"	PD	41204	\$ 77 ea	End Shoe - Right 22 3/4" x 16 1/2"	1/4"	PD	40313	\$ 50 ea
Left Outside (L1) 22 3/4" x 16 1/2"	3/8"	PD	50124	\$ 108 ea	End Shoe - Right LOW SERIAL #655299 & Lower	3/8"	PD	50132	\$ 56 ea
	1/4"	PD	41202	\$ 77 ea	End Shoe - Right HIGH SERIAL #655300 & Higher	1/4"	PD	40314	\$ 37 ea
Left Inside (L2) 23 5/8" x 16 1/2"	3/8"	PD	50125	\$ 108 ea	Stabilizer Pad 18" x 24"	3/8"	PD	50131	\$ 52 ea
	1/4"	PD	41203	\$ 77 ea		1/4"	PD	41188	\$ 46 ea
Notched Cut 19 5/8" x 16 1/2"	3/8"	PD	50126	\$ 101 ea					
	1/4"	PD	40308	\$ 71 ea					

*PD = Predrilled
Hardware included = 12-16 Pound Rivets for 3/8" kits & parts; 10-16 Pound Rivets for 1/4" kits & parts.
Part 80045 (1/8" Shoe Divider) uses 68 Small Head Pop Rivets.
Extra rivets can be purchased on page 149.

Also available for easy installation:
May Wes Pound Rivet Tool
81320 \$ 40 ea

PREMIUM POLY SKID SHOES - HARDWARE INCLUDED

SKID SHOES FOR JOHN DEERE 200F SERIES - 3/8" & 1/4" THICK

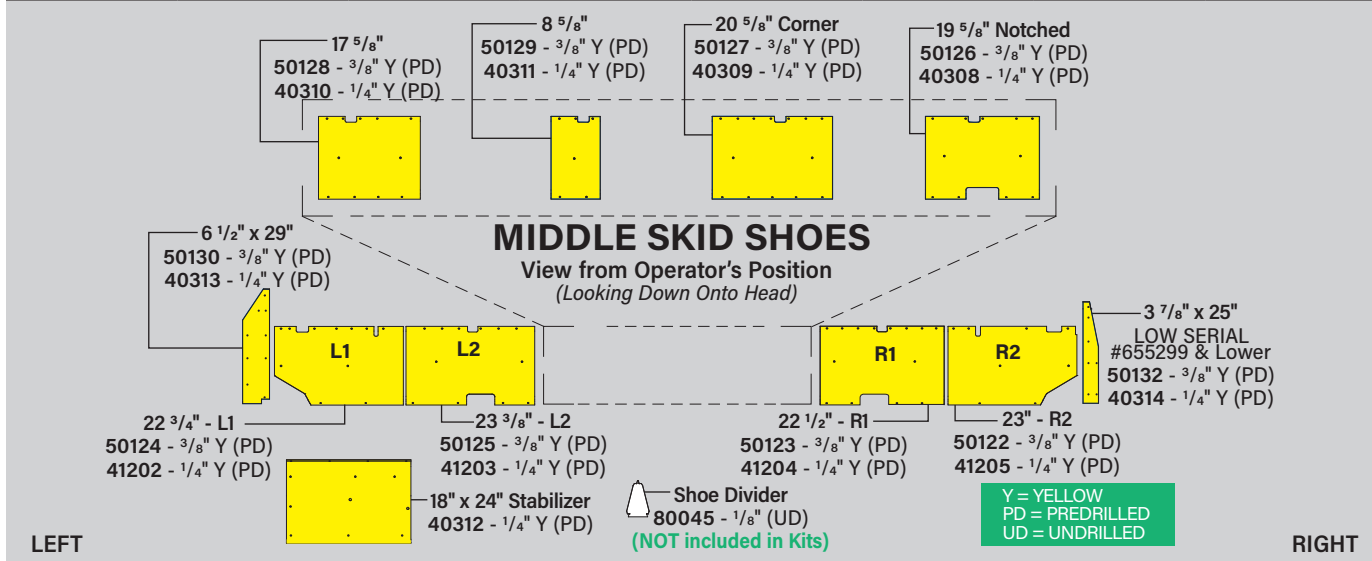

KITS FOR JOHN DEERE 200F SERIES - 3/8" & 1/4" THICK

SET SIZE	SHOE THICKNESS	PD*	PART NO. - YELLOW	RETAIL PRICE	SET SIZE	SHOE THICKNESS	PD*	PART NO. - YELLOW	RETAIL PRICE
24 ft	3/8"	PD	90102	\$ 1234 set	16 ft	3/8"	PD	90107	\$ 942 set
	1/4"	PD	80552	\$ 920 set		15 ft	1/4"	PD	80858
22 ft	3/8"	PD	90104	\$ 1139 set	13 ft		3/8"	PD	90109
	1/4"	PD	80792	\$ 886 set		13 ft	1/4"	PD	81065
20 ft	3/8"	PD	90105	\$ 1113 set	13 ft		3/8"	PD	90110
	1/4"	PD	80024	\$ 866 set		13 ft	1/4"	PD	81066
18 ft	3/8"	PD	90106	\$ 1007 set					
	1/4"	PD	80020	\$ 839 set					

REPLACEMENT PARTS FOR JOHN DEERE 200F SERIES - 3/8" & 1/4" THICK

DESCRIPTION	SHOE THICKNESS	PD*	PART NO. YELLOW	RETAIL PRICE	DESCRIPTION	SHOE THICKNESS	PD*	PART NO. YELLOW	RETAIL PRICE
Left End Kit (L1) & (L2)	3/8"	PD	50120	\$ 204 ea	Corner Cut	3/8"	PD	50127	\$ 102 ea
	1/4"	PD	41254	\$ 146 ea	20 5/8" x 16 1/2"	1/4"	PD	40309	\$ 72 ea
Right End Kit (R1) & (R2)	3/8"	PD	50121	\$ 204 ea	Middle	3/8"	PD	50128	\$ 102 ea
	1/4"	PD	41259	\$ 146 ea	17 5/8" x 16 1/2"	1/4"	PD	40310	\$ 63 ea
Right Outside (R2) 23" x 16 1/2"	3/8"	PD	50122	\$ 108 ea	Middle	3/8"	PD	50129	\$ 58 ea
	1/4"	PD	41205	\$ 77 ea	8 5/8" x 16 1/2"	1/4"	PD	40311	\$ 38 ea
Right Inside (R1) 22 1/2" x 16 1/2"	3/8"	PD	50123	\$ 108 ea	End Shoe - Left	3/8"	PD	50130	\$ 57 ea
	1/4"	PD	41204	\$ 77 ea	6 1/2" x 29"	1/4"	PD	40313	\$ 50 ea
Left Outside (L1) 22 3/4" x 16 1/2"	3/8"	PD	50124	\$ 108 ea	End Shoe - Right	3/8"	PD	50132	\$ 56 ea
	1/4"	PD	41202	\$ 77 ea	3 7/8" x 25"	1/4"	PD	40314	\$ 37 ea
Left Inside (L2) 23 5/8" x 16 1/2"	3/8"	PD	50125	\$ 108 ea	Stabilizer Pad	1/4"	PD	40312	\$ 79 ea
	1/4"	PD	41203	\$ 77 ea	18" x 24"				
Notched Cut	3/8"	PD	50126	\$ 101 ea					
19 5/8" x 16 1/2"	1/4"	PD	40308	\$ 71 ea					

*PD = Predrilled
Hardware included = 12-16 Pound Rivets for 3/8" kits & parts;
10-16 Pound Rivets for 1/4" kits & parts.
Part 80045 (1/8" Shoe Divider) uses 68 Small Head Pop Rivets.
Extra rivets can be purchased on page 149.

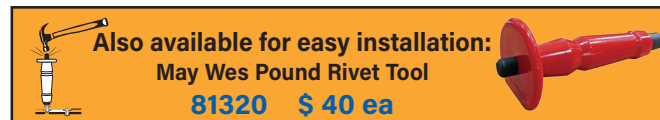

PREMIUM POLY SKID SHOES - HARDWARE INCLUDED

SKID SHOES FOR JOHN DEERE RDF / 700FD & 600FD SERIES 2016 & NEWER AFTER SERIAL #785000 - 3/8" & 1/4" THICK

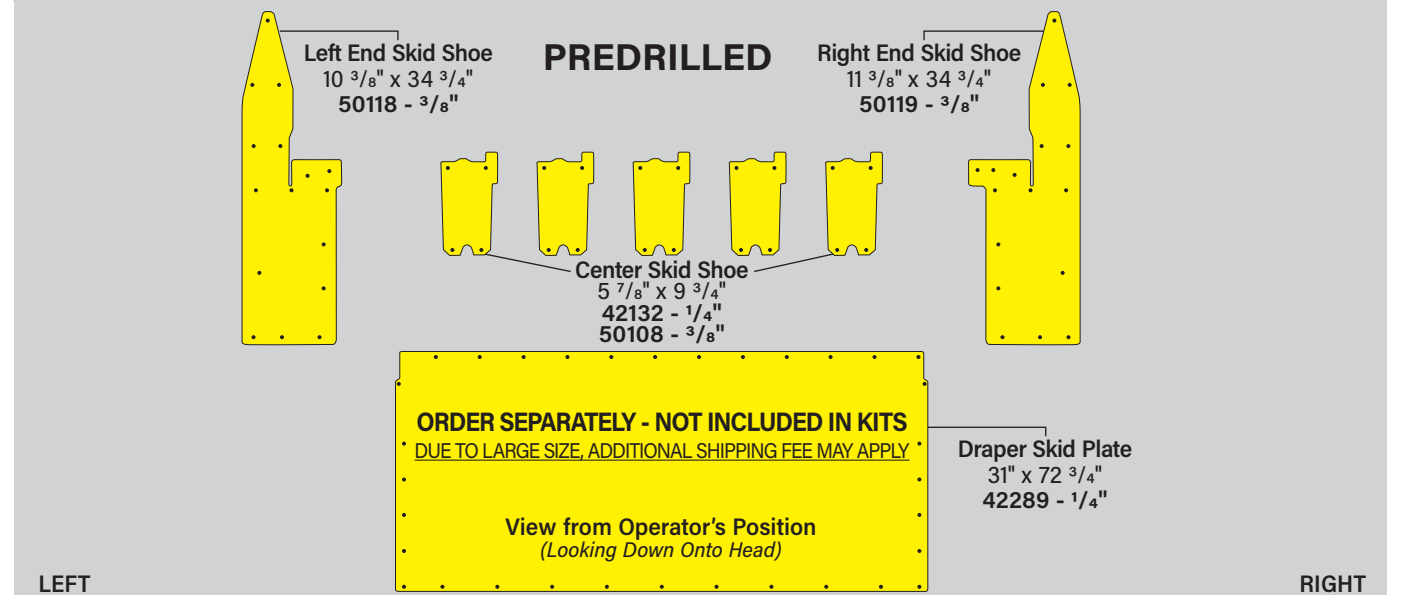

KITS FOR JOHN DEERE RDF / 700FD & 600FD SERIES 2016 & Newer After Serial #785000 - 3/8" & 1/4" THICK

SET SIZE	SHOE THICKNESS	PD*	PART NO. YELLOW	RETAIL PRICE
45 ft	3/8"	PD	90093	\$ 1131 set
	1/4"	PD	83675	\$ 995 set
40 ft	3/8"	PD	90092	\$ 1002 set
	1/4"	PD	83674	\$ 883 set
35 ft	3/8"	PD	90091	\$ 929 set
	1/4"	PD	83673	\$ 775 set
30 ft	3/8"	PD	90090	\$ 853 set
	1/4"	PD	83672	\$ 663 set

REPLACEMENT PARTS FOR JOHN DEERE RDF / 700FD & 600FD SERIES 2016 & Newer After Serial #785000 - 3/8" & 1/4" THICK

DESCRIPTION	SIZE	SHOE THICKNESS	PD*	PART NO. YELLOW	RETAIL PRICE
Left End Skid Shoe	10 3/8" x 34 3/4"	3/8"	PD	50118	\$ 122 ea
Center Skid Shoe	5 7/8" x 9 3/4"	3/8"	PD	50108	\$ 21 ea
Center Skid Shoe	5 7/8" x 9 3/4"	1/4"	PD	42132	\$ 16 ea
Right End Skid Shoe	11 3/8" x 34 3/4"	3/8"	PD	50119	\$ 122 ea
Draper Skid Plate	31" x 72 3/4"	1/4"	PD	42289	\$ 347 ea

*PD = Predrilled Hardware included = Size 88 Small Head Pop Rivets.
Extra rivets can be purchased on page 149.



Learn more about May Wes Poly Skid Shoes

Scan the QR code with your smartphone to watch our FAQ video on YouTube.

PREMIUM POLY SKID SHOES - HARDWARE INCLUDED

**SKID SHOES FOR JOHN DEERE 600FD SERIES
2012 to 2015 - 3/8" & 1/4" THICK**

PREDRILLED

ORDER SEPARATELY (NOT INCLUDED IN KITS)
DUE TO LARGE SIZE, ADDITIONAL SHIPPING FEE MAY APPLY
View from Operator's Position (Looking Down Onto Head)

Center Skid Shoe
5 7/8" x 9 3/4" 42132 - 1/4" 50108 - 3/8"
5 1/2" x 9 3/4" 41484 - 1/4" 50103 - 3/8"
5 3/4" x 10" 42231 - 1/4" 50117 - 3/8"
5 1/2" x 4 1/2" 42230 - 1/4" 50116 - 3/8"

Left End Skid Shoe
11 5/8" x 34 3/4" 50106 - 3/8"

Right End Skid Shoe
11 3/8" x 34 3/4" 50107 - 3/8"

Draper Skid Plate
31" x 63 1/2" 42196 - 1/4"
Order separately - NOT INCLUDED in kits

KITS FOR JOHN DEERE 600FD SERIES - 2015 - 3/8" & 1/4" THICK

SET SIZE	SHOE THICKNESS	PD*	PART NO. - YELLOW	RETAIL PRICE	SET SIZE	SHOE THICKNESS	PD*	PART NO. - YELLOW	RETAIL PRICE
45 ft	3/8"	PD	90089	\$ 1247 set	35 ft	3/8"	PD	90087	\$ 931 set
	1/4"	PD	83637	\$ 995 set		1/4"	PD	83635	\$ 775 set
40 ft	3/8"	PD	90088	\$ 1131 set	30 ft	3/8"	PD	90086	\$ 855 set
	1/4"	PD	83636	\$ 883 set		1/4"	PD	83634	\$ 663 set

KITS FOR JOHN DEERE 600FD SERIES - 2013 & 2014 - 3/8" & 1/4" THICK

SET SIZE	SHOE THICKNESS	PD*	PART NO. - YELLOW	RETAIL PRICE	SET SIZE	SHOE THICKNESS	PD*	PART NO. - YELLOW	RETAIL PRICE
40 ft	3/8"	PD	90076	\$ 1072 set	30 ft	3/8"	PD	90082	\$ 855 set
	1/4"	PD	83568	\$ 886 set		1/4"	PD	83585	\$ 665 set
35 ft	3/8"	PD	90075	\$ 964 set					
	1/4"	PD	83567	\$ 775 set					

KITS FOR JOHN DEERE 600FD SERIES - 2012 - 3/8" & 1/4" THICK

SET SIZE	SHOE THICKNESS	PD*	PART NO. - YELLOW	RETAIL PRICE	SET SIZE	SHOE THICKNESS	PD*	PART NO. - YELLOW	RETAIL PRICE
40 ft	3/8"	PD	90085	\$ 1005 set	30 ft	3/8"	PD	90083	\$ 855 set
	1/4"	PD	83633	\$ 882 set		1/4"	PD	83631	\$ 663 set
35 ft	3/8"	PD	90084	\$ 931 set					
	1/4"	PD	83632	\$ 692 set					

REPLACEMENT PARTS FOR JOHN DEERE 600FD SERIES - 3/8" & 1/4" THICK

DESCRIPTION	SIZE	SHOE THICKNESS	PD*	PART NO. - YELLOW	RETAIL PRICE
Left End Skid Shoe	11 5/8" x 34 3/4"	3/8"	PD	50106	\$ 122 ea
Center Skid Shoe	5 7/8" x 9 3/4"	3/8"	PD	50108	\$ 21 ea
	5 7/8" x 9 3/4"	1/4"	PD	42132	\$ 16 ea
Center Skid Shoe	5 1/2" x 9 3/4"	3/8"	PD	50103	\$ 18 ea
	5 1/2" x 9 3/4"	1/4"	PD	41484	\$ 15 ea
Center Skid Shoe	5 3/4" x 10"	3/8"	PD	50117	\$ 20 ea
	5 3/4" x 10"	1/4"	PD	42231	\$ 16 ea
Center Skid Shoe	5 1/2" x 4 1/4"	3/8"	PD	50116	\$ 16 ea
	5 1/2" x 4 1/4"	1/4"	PD	42230	\$ 14 ea
Right End Skid Shoe	11 3/8" x 34 3/4"	3/8"	PD	50107	\$ 122 ea
Draper Skid Plate	31" x 63 1/2"	1/4"	PD	42196	\$ 336 ea

*PD = Predrilled
Hardware included = Size 88 Small Head Pop Rivets. Extra rivets can be purchased on page 149.

PREMIUM POLY SKID SHOES - HARDWARE INCLUDED

SKID SHOES FOR MACDON FD1 / D1 & FD75 / D65 DRAPER - 3/8" & 1/4" THICK

THICKER than OEM

No Kits - All Items Sold Separately

PREDRILLED

Cutterbar Skid Shoe Qty Required

HEAD WIDTH	QUANTITY
30'	60
35'	70
40'	80
45'	90

Cutterbar Skid Shoe - 6" x 6.5"
22723/83840 - 3/8"

Left End Skid Shoe
11" x 15" 42054 - 3/8"

Transition Pan Skid Shoe
7" x 19" 42061 - 1/4"

Right End Skid Shoe
11" x 15" 42055 - 3/8"

Center Skid Shoe Assembly
14" x 16"
Replaces OEM molded center skid shoe.
42319 - 3/8"

Draper Skid Plate
CA25 Adapter
CA20 Adapter (2012 & Newer)
35 7/16" x 79"
42300 - 1/4"

DUE TO LARGE SIZE, ADDITIONAL SHIPPING FEE MAY APPLY
DOES NOT FIT FD1 SERIES HEADS

View from Operator's Position (Looking Down Onto Head)

REPLACEMENT PARTS FOR MACDON FD1 / D1 DRAPER - 3/8" & 1/4" THICK

DESCRIPTION	SHOE THICKNESS	PD*	SIZE	PART NO. - WHITE	RETAIL PRICE
Left End Skid Shoe	3/8"	PD	11" x 15"	42054	\$ 63 ea
Right End Skid Shoe	3/8"	PD	11" x 15"	42055	\$ 63 ea
Transition Pan Skid Shoe	1/4"	PD	7" x 19"	42061	\$ 47 ea
Center Skid Shoe Assembly	3/8"	PD	14" x 16"	42319	\$ 196 ea

Includes Metal Skid Plate, Poly Skid Shoe & Hardware

REPLACEMENT PARTS FOR MACDON FD75 / D65 DRAPER - 3/8" & 1/4" THICK

DESCRIPTION	SHOE THICKNESS	PD*	SIZE	PART NO. - WHITE	RETAIL PRICE
Left End Skid Shoe	3/8"	PD	11" x 15"	42054	\$ 63 ea
Right End Skid Shoe	3/8"	PD	11" x 15"	42055	\$ 63 ea
Transition Pan Skid Shoe	1/4"	PD	7" x 19"	42061	\$ 47 ea
Center Skid Shoe Assembly	3/8"	PD	14" x 16"	42319	\$ 196 ea
Draper Skid Plate CA25 Adapter & CA20 Adapter - 2012 & Newer	1/4"	PD	35 7/16" x 79"	42300	\$ 347 ea
Cutterbar Skid Shoe	3/8"	PD	6" x 6 1/2"	22723	\$ 12 ea
Cutterbar Skid Shoe - 10pk	3/8"	PD	6" x 6 1/2"	83840	\$ 109 pk

DUE TO LARGE SIZE, ADDITIONAL SHIPPING FEE MAY APPLY. DOES NOT FIT FD1 SERIES HEADS.
Hardware not included. Reuse OEM hardware.

*PD = Predrilled Hardware included = Size 86 Small Head Pop Rivets. Extra rivets can be purchased on page 149.

Center Skid Shoe Assembly
14" x 16"
3/8" Thickness
42319 \$ 196

Includes Metal Skid Plate, Poly Skid Shoe & Mounting Hardware

Reuse your Factory OEM Mount Brackets for Installation

Questions? Scan the code to learn more.

SKID SHOES

PREMIUM POLY SKID SHOES - HARDWARE INCLUDED

SKID SHOES FOR MACDON FD70 / D60 / D50 DRAPER - 3/8" THICK

PREDRILLED

THICKER than OEM

Cutterbar Skid Shoe Qty Required

HEAD WIDTH	QUANTITY
30'	60
35'	70
40'	80
45'	90

Cutterbar Skid Shoe - 6" x 6.5"
22723/83840 - 3/8"
(Order separately - NOT INCLUDED in kits)

Transition Pan Skid Shoe - 7" x 19"
42061 - 3/8"
(Order separately - NOT INCLUDED in kits)

Left End Skid Shoe - 11" x 15"
42054 - 3/8"

Center Skid Shoe - 14" x 16"
42053 - 3/8"

Right End Skid Shoe - 11" x 15"
42055 - 3/8"

ORDER SEPARATELY - NOT INCLUDED IN KITS
DUE TO LARGE SIZE, ADDITIONAL SHIPPING FEE MAY APPLY

Center Skid Shoe Assembly - 14" x 16"
42319 - 3/8"
(Order separately - NOT INCLUDED in kits)

View from Operator's Position
(Looking Down Onto Head)

Draper Skid Plate CA20 Adapter (2011 & Older)
See page 76 for 2012 & Newer
35 3/16" x 76 5/8"
42299 - 1/4"
(Order separately - NOT INCLUDED in kits)

LEFT RIGHT

KITS FOR MACDON FD70 / D60 / D50 DRAPER - 3/8" THICK

SET SIZE	SHOE THICKNESS	PD*	PART NO - WHITE	RETAIL PRICE
45 ft	3/8" Centers & Ends	PD	83490	\$ 360 set
40 ft	3/8" Centers & Ends	PD	83490	\$ 360 set
35 ft	3/8" Centers & Ends	PD	83490	\$ 360 set
30 ft	3/8" Centers & Ends	PD	83490	\$ 360 set

REPLACEMENT PARTS FOR MACDON FD70 / D60 / D50 DRAPER - 3/8" THICK

DESCRIPTION	SHOE THICKNESS	PD*	SIZE	PART NO - WHITE	RETAIL PRICE
Left End Skid Shoe	3/8"	PD	11" x 15"	42054	\$ 63 ea
Right End Skid Shoe	3/8"	PD	11" x 15"	42055	\$ 63 ea
Center Skid Shoe	3/8"	PD	14" x 16"	42053	\$ 65 ea
Transition Pan Skid Shoe <i>Sold Separately</i>	3/8"	PD	7" x 19"	42061	\$ 47 ea
Center Skid Shoe Assembly <i>Sold Separately. Includes Metal Skid Plate, Poly Skid Shoe & Hardware.</i>	3/8"	PD	14" x 16"	42319	\$ 196 ea
Draper Skid Plate CA20 Adapter <i>- 2011 & Older Sold Separately</i>	1/4"	PD	35 3/16" x 76 5/8"	42299	\$ 347 ea
<i>DUE TO LARGE SIZE, ADDITIONAL SHIPPING FEE MAY APPLY.</i>					
Cutterbar Skid Shoe	3/8"	PD	6" x 6 1/2"	22723	\$ 12 ea
<i>Sold Separately. Hardware not included. Reuse OEM hardware.</i>					
Cutterbar Skid Shoe - 10pk	3/8"	PD	6" x 6 1/2"	83840	\$ 109 pk
<i>Sold Separately. Hardware not included. Reuse OEM hardware.</i>					

*PD = Predrilled Hardware included = Nuts & Bolts.

Center Skid Shoe Assembly
14" x 16"
3/8" Thickness
42319 \$ 196

Includes Metal Skid Plate, Poly Skid Shoe & Mounting Hardware

Reuse your Factory OEM Mount Brackets for Installation

Questions? Scan the code to learn more.

PREMIUM POLY SKID SHOES - HARDWARE INCLUDED

SKID SHOES FOR MACDON 974 / 973 DRAPER 2006 & NEWER - 3/8" THICK

PREDRILLED

THICKER than OEM

Cutterbar Skid Shoe Qty Required

HEAD WIDTH	QUANTITY
30'	60
35'	70
40'	80
45'	90

Cutterbar Skid Shoe - 6" x 6.5"
22723/83840 - 3/8"
(Order separately - NOT INCLUDED in kits)

Left End Skid Shoe - 3" x 8 1/2"
42056 - 3/8"

Right End Skid Shoe - 3" x 8 1/2"
42057 - 3/8"

Center Skid Shoe - 17 1/4" x 23"
41567 - 3/8"

Outer Skid Shoe - 11 3/4" x 15"
41566 - 3/8"

View from Operator's Position
(Looking Down Onto Head)

LEFT RIGHT

KITS FOR MACDON 974 DRAPER - 2006 & NEWER - 3/8" THICK

SET SIZE	SHOE THICKNESS	PD*	PART NO - WHITE	RETAIL PRICE
36 ft	3/8"	PD	83502	\$ 551 set
30 ft	3/8"	PD	83502	\$ 551 set
25 ft	3/8"	PD	83501	\$ 220 set
21 ft	3/8"	PD	83501	\$ 220 set

KITS FOR MACDON 973 DRAPER - 2006 & NEWER - 3/8" THICK

SET SIZE	SHOE THICKNESS	PD*	PART NO - WHITE	RETAIL PRICE
39 ft	3/8"	PD	83500	\$ 392 set
36 ft	3/8"	PD	83500	\$ 392 set
30 ft	3/8"	PD	83500	\$ 392 set

REPLACEMENT PARTS FOR MACDON 974 / 973 DRAPER - 2006 & NEWER - 3/8" THICK

DESCRIPTION	SHOE THICKNESS	PD*	SIZE	PART NO - WHITE	RETAIL PRICE
Left End Skid Shoe	3/8"	PD	3" x 8 1/2"	42056	\$ 29 ea
Right End Skid Shoe	3/8"	PD	3" x 8 1/2"	42057	\$ 29 ea
Center Skid Shoe	3/8"	PD	17 1/4" x 23"	41567	\$ 83 ea
Outer Skid Shoe	3/8"	PD	11 3/4" x 15"	41566	\$ 40 ea
Cutterbar Skid Shoe	3/8"	PD	6" x 6 1/2"	22723	\$ 12 ea
<i>Sold Separately. Hardware not included. Reuse OEM hardware.</i>					
Cutterbar Skid Shoe - 10pk	3/8"	PD	6" x 6 1/2"	83840	\$ 109 pk
<i>Sold Separately. Hardware not included. Reuse OEM hardware.</i>					

*PD = Predrilled Hardware included = Nuts & Bolts
Part 41567 (Center Skid Shoe) uses 68 Small Head Pop Rivets. Extra rivets can be purchased on page 149.

Check out our website - WWW.MAYWES.COM for more information, installation instructions and our full lineup of poly products.

SKID SHOES

PREMIUM POLY SKID SHOES - HARDWARE INCLUDED

**SKID SHOES FOR MACDON 974 /973 DRAPER
2005 & OLDER - 3/8" THICK**

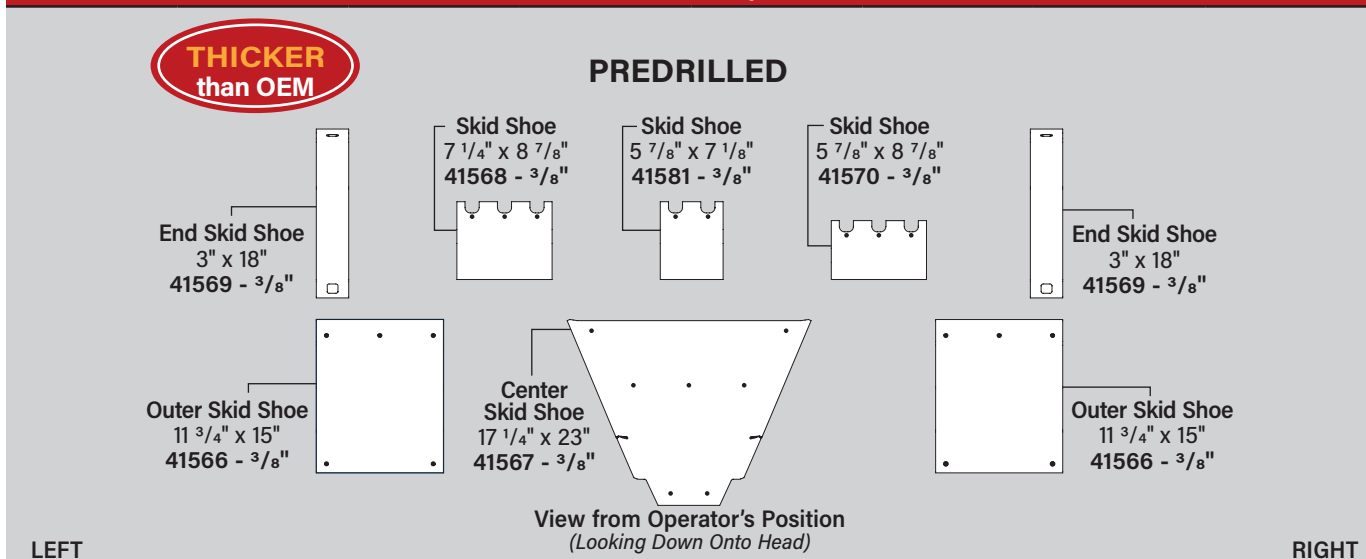

KITS FOR MACDON 974 DRAPER - 2005 & OLDER - 3/8" THICK

SET SIZE	SHOE THICKNESS	PD*	PART NO - WHITE	RETAIL PRICE
36 ft	3/8"	PD	82576	\$ 1360 set
30 ft	3/8"	PD	82577	\$ 1185 set
25 ft	3/8"	PD	83494	\$ 1046 set
21 ft	3/8"	PD	83493	\$ 840 set

KITS FOR MACDON 973 DRAPER - 2005 & OLDER - 3/8" THICK

SET SIZE	SHOE THICKNESS	PD*	PART NO - WHITE	RETAIL PRICE
39 ft	3/8"	PD	83499	\$ 1650 set
36 ft	3/8"	PD	83498	\$ 1329 set
30 ft	3/8"	PD	83497	\$ 1144 set
25 ft	3/8"	PD	83496	\$ 958 set
21 ft	3/8"	PD	83495	\$ 820 set

REPLACEMENT PARTS FOR MACDON 974 /973 DRAPER - 2005 & OLDER - 3/8" THICK

DESCRIPTION	SHOE THICKNESS	PD*	SIZE	PART NO - WHITE	RETAIL PRICE
End Skid Shoe	3/8"	PD	3" x 18"	41569	\$ 43 ea
Outer Skid Shoe	3/8"	PD	11 3/4" x 15"	41566	\$ 40 ea
Center Skid Shoe	3/8"	PD	17 1/4" x 23"	41567	\$ 83 ea
Skid Shoe	3/8"	PD	7 1/4" x 8 7/8"	41568	\$ 31 ea
Skid Shoe	3/8"	PD	5 7/8" x 7 1/8"	41581	\$ 29 ea
Skid Shoe	3/8"	PD	5 7/8" x 8 7/8"	41570	\$ 29 ea

*PD = Predrilled
Hardware included = Nuts & Bolts
Parts 41567, 41568, 41581 and 41570 use 68 Small Head Pop Rivets. Extra rivets can be purchased on page 149.

POLY PICKUP BANDS
A PRACTICAL REPLACEMENT FOR OEM METAL PICKUP BANDS
STARTING ON PAGE 40

PREMIUM POLY SKID SHOES - HARDWARE INCLUDED

**SKID SHOES FOR CLAAS /LEXION /CATERPILLAR
F900 /F750 /F530 /F525 /F30 /F20 FLEX HEADS - 1/4" THICK**

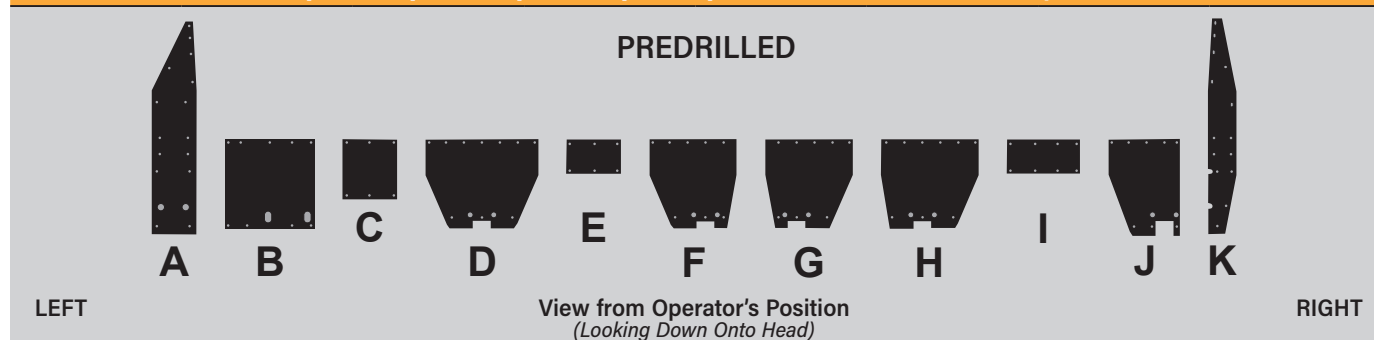

KITS FOR CLAAS /LEXION /CATERPILLAR F900 /F750 /F530 /F525 /F30 /F20 FLEX HEADS - 1/4" THICK

SET SIZE	SHOE THICKNESS	PD*	PART NO - BLACK	RETAIL PRICE
30 ft	1/4"	PD	82011	\$ 1391 set
25 ft	1/4"	PD	82012	\$ 1185 set
20 ft	1/4"	PD	82013	\$ 943 set
17 ft	1/4"	PD	82014	\$ 798 set
15 ft	1/4"	PD	82015	\$ 710 set

REPLACEMENT PARTS FOR CLAAS /LEXION /CATERPILLAR F900 /F750 /F530 /F525 /F30 /F20 FLEX HEADS - 1/4" THICK

DESCRIPTION	SHOE THICKNESS	PD*	SIZE	PART NO - BLACK	RETAIL PRICE
Left End Skid Shoe	1/4"	PD	(A) 7 3/4" x 40"	41040	\$ 74 ea
Skid Shoe	1/4"	PD	(B) 16" x 15 3/4"	41041	\$ 68 ea
Skid Shoe	1/4"	PD	(C) 9 5/8" x 10 3/4"	41036	\$ 33 ea
Skid Shoe	1/4"	PD	(D) 16 1/4" x 19 3/4"	41031	\$ 73 ea
Skid Shoe	1/4"	PD	(E) 6 1/8" x 9 5/8"	41034	\$ 29 ea
Skid Shoe	1/4"	PD	(F) 16 1/4" x 15 1/4"	41037	\$ 65 ea
Skid Shoe	1/4"	PD	(G) 16 1/4" x 15 1/4"	41038	\$ 65 ea
Skid Shoe	1/4"	PD	(H) 17 1/8" x 17 5/8"	41033	\$ 73 ea
Skid Shoe	1/4"	PD	(I) 6 1/8" x 12 3/4"	41035	\$ 31 ea
Skid Shoe	1/4"	PD	(J) 12 5/8" x 17 5/8"	41032	\$ 65 ea
Right End Skid Shoe	1/4"	PD	(K) 7 7/8" x 40"	41039	\$ 56 ea

*PD = Predrilled
Hardware included = 10-16 Pound Rivets. Extra rivets can be purchased on page 149.

AUGER WEARSHOES
PROTECT METAL AGAINST WEAR AND CORROSION
Bolt-on poly for new or worn steel auger flighting.
• Combines Grain carts
• Transport augers and more
HIGH ABRASION RESISTANCE
STARTING ON PAGE 126

CENTER SKID SHOE
(10.25" x 9") - 3/8" Thick
Fits Models:
LEXION F540/F535/G540/G535
CLAAS MAXFLEX 1200/1050
CLAAS MAXFLEX 930/770
42728 - \$ 24 ea
Replaces OEM Part #3591080
Includes Hardware, Size #86 Small Head Pop Rivets.

PREMIUM POLY SKID SHOES - HARDWARE INCLUDED

SKID SHOES FOR GLEANER / MASSEY 400 / 500 / 700 / 700C / 800 / 800C / 7000 / 8000 & SERIES III - 1987 & NEWER - 1/4" THICK

PREDRILLED & UNDRILLED

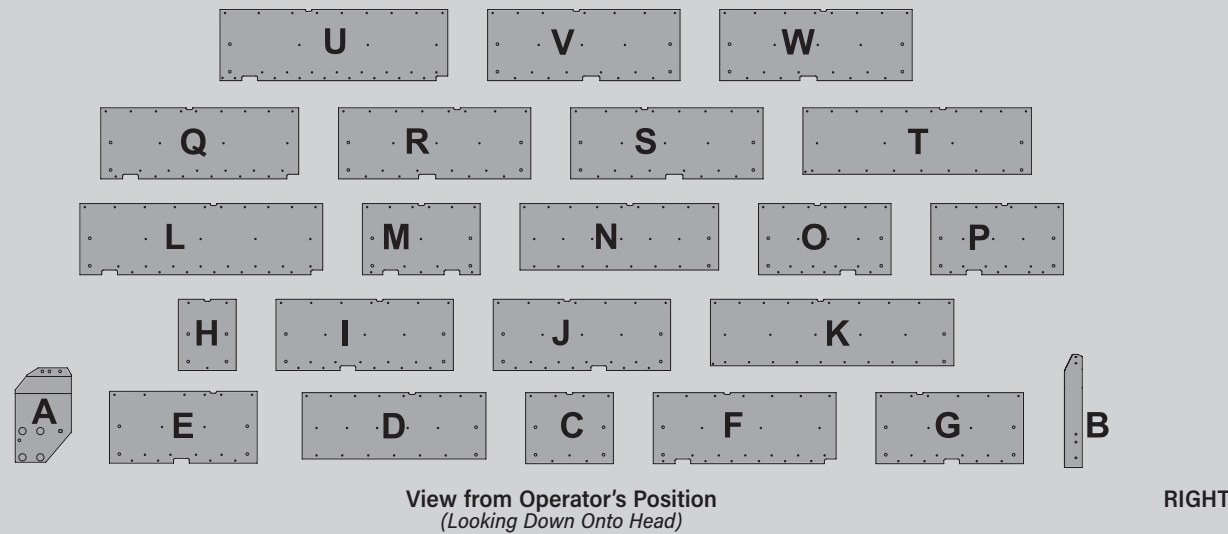

KITS FOR GLEANER / MASSEY 400 / 500 / 700 / 700C / 800 / 800C / 7000 / 8000 & SERIES III - (1987 & NEWER) 1/4" THICK

SET SIZE	SHOE THICKNESS	PD*/UD**	PART NO. - SILVER	PART NO. - WHITE	RETAIL PRICE
30 ft	1/4"	PD	81669	-	\$ 1104 set
25 ft	1/4"	PD	81671	-	\$ 847 set
24 ft	1/4"	PD	81672	-	\$ 847 set
	1/4"	UD	-	81716	\$ 704 set
22 ft	1/4"	PD	81673	-	\$ 794 set
	1/4"	UD	-	81483	\$ 623 set
20 ft	1/4"	PD	81674	-	\$ 743 set
	1/4"	UD	-	81482	\$ 574 set
18 ft	1/4"	PD	81675	-	\$ 644 set
	1/4"	UD	-	81481	\$ 541 set
16 ft	1/4"	PD	81676	-	\$ 614 set
	1/4"	UD	-	81480	\$ 488 set
15 ft	1/4"	PD	81677	-	\$ 596 set
	1/4"	UD	-	81479	\$ 421 set
13 ft	1/4"	PD	81678	-	\$ 535 set
	1/4"	UD	-	81478	\$ 372 set

*PD = Predrilled, **UD = Undrilled
Hardware included = 10-16 Pound Rivets. Extra rivets can be purchased on page 149. End Shoes "A" and "B" use Nuts & Bolts.

Also available for easy installation:
May Wes Pound Rivet Tool
81320 \$ 40 ea



PREMIUM POLY SKID SHOES - HARDWARE INCLUDED

REPLACEMENT PARTS FOR GLEANER / MASSEY 400 / 500 / 700 / 700C / 800 / 800C / 7000 / 8000 & SERIES III - 1987 & NEWER - 1/4" THICK

PREDRILLED & UNDRILLED

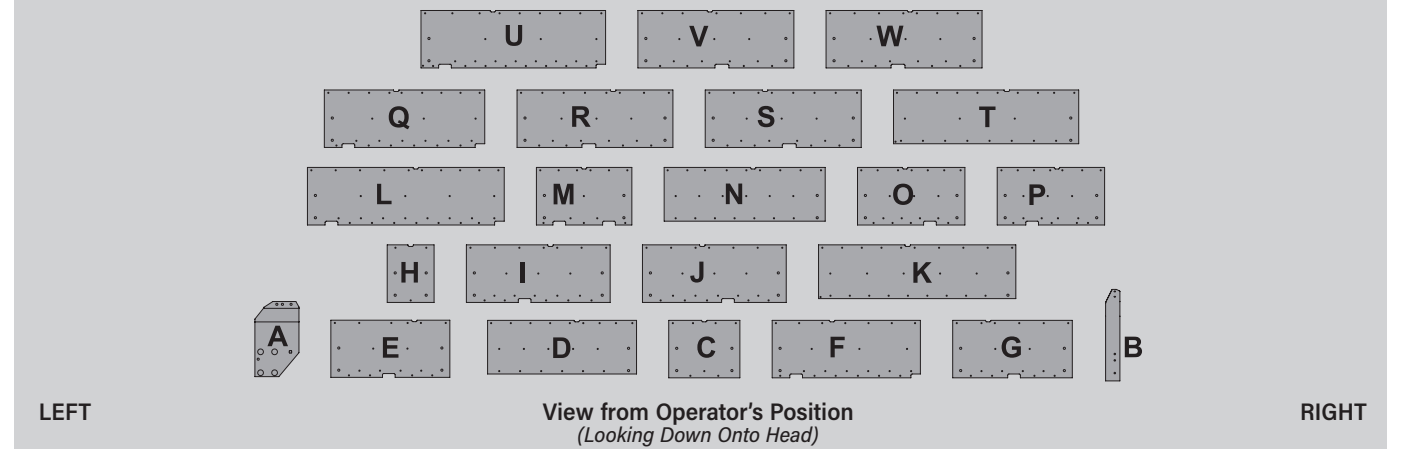

REPLACEMENT PARTS FOR GLEANER / MASSEY 400 / 500 / 700 / 700C / 800 / 800C / 7000 / 8000 & SERIES III - (1987 & NEWER) - 1/4" THICK

DESCRIPTION	SHOE THICKNESS	PD*/UD**	PART NO LEFT - SILVER	PART NO RIGHT - SILVER	RETAIL PRICE	PART NO RIGHT - WHITE	RETAIL PRICE
49" x 14" End	1/4"	PD	(L) 40344	(K) 40343	\$ 185 ea	-	-
	1/4"	UD	-	-	-	40398	\$ 126 ea
46" x 14" End	1/4"	PD	(U) 40356	(T) 40355	\$ 177 ea	-	-
	1/4"	UD	-	-	-	40397	\$ 124 ea
40" x 14" End	1/4"	PD	(Q) 40354	(N) 40353	\$ 162 ea	-	-
	1/4"	UD	-	-	-	40396	\$ 119 ea
38 5/8" x 14"	1/4"	PD	(R) 40342	(S) 40352	\$ 150 ea	-	-
	1/4"	UD	-	-	-	40393	\$ 105 ea
37" x 14"	1/4"	PD	(D) 40351	(F) 40350	\$ 142 ea	-	-
	1/4"	UD	-	-	-	40394	\$ 106 ea
35 5/8" x 14"	1/4"	PD	(I) 40341	(J) 40349	\$ 135 ea	-	-
	1/4"	UD	-	-	-	40392	\$ 130 ea
29 5/8" x 14"	1/4"	PD	(E) 40340	(G) 40348	\$ 116 ea	-	-
	1/4"	UD	-	-	-	40391	\$ 80 ea
26 5/8" x 14"	1/4"	PD	(O) 40339	(P) 40347	\$ 103 ea	-	-
	1/4"	UD	-	-	-	40390	\$ 71 ea
23 5/8" x 14"	1/4"	PD	-	(M) 40338	\$ 91 ea	-	-
	1/4"	UD	-	-	-	40389	\$ 67 ea
17 5/8" x 14"	1/4"	PD	-	(C) 40337	\$ 68 ea	-	-
	1/4"	UD	-	-	-	40388	\$ 54 ea
11 5/8" x 14"	1/4"	PD	-	(H) 40336	\$ 51 ea	-	-
	1/4"	UD	-	-	-	40387	\$ 34 ea
38 5/8" x 14" End Shoe	1/4"	PD	(V) 40893	(W) 40892	\$ 150 ea	-	-
11" x 20 1/2"	1/4"	PD	(A) 40346	-	\$ 51 ea	-	-
3 3/4" x 26"	1/4"	PD	-	(B) 40345	\$ 35 ea	-	-
End Shoes	1/4"	UD	-	-	-	40175	\$ 88 ea

*PD = Predrilled, **UD = Undrilled
Hardware included = 10-16 Pound Rivets. Extra rivets can be purchased on page 149.
Parts 40346 (A), 40345 (B) and 40175 use Nuts & Bolts.

PREMIUM POLY SKID SHOES - HARDWARE INCLUDED

**SKID SHOES FOR GLEANER / MASSEY SERIES III
PRE-1987 - 1/4" THICK**

PREDRILLED & UNDRILLED

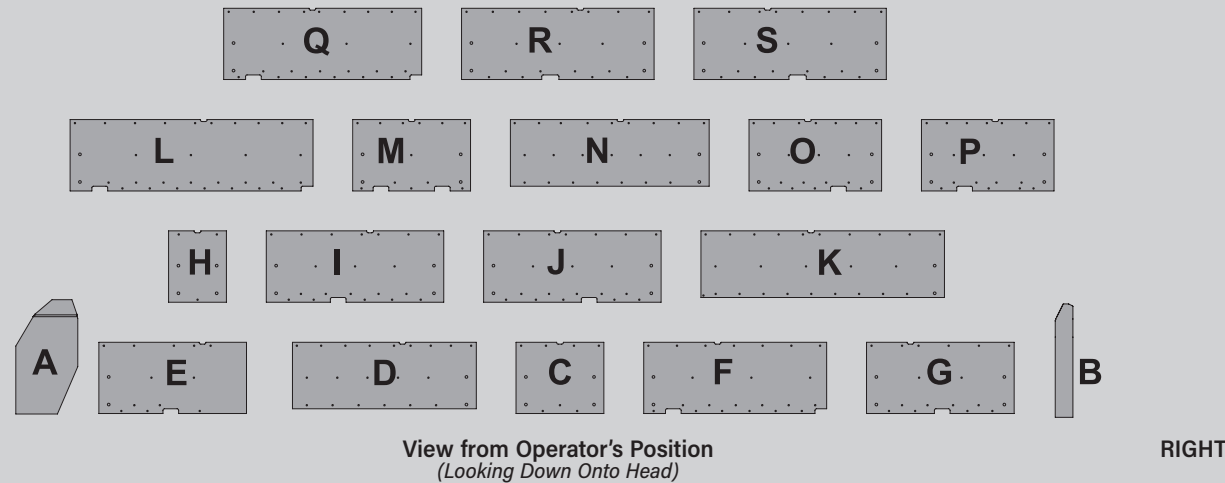

KITS FOR GLEANER / MASSEY SERIES III - PRE-1987 - 1/4" THICK

SET SIZE	SHOE THICKNESS	PD*/UD**	PART NO - SILVER	PART NO - WHITE	RETAIL PRICE
24 ft	1/4"	PD	80201	-	\$ 847 set
	1/4"	UD	-	80203	\$ 656 set
22 ft	1/4"	PD	80198	-	\$ 794 set
	1/4"	UD	-	80200	\$ 605 set
20 ft	1/4"	PD	80195	-	\$ 753 set
	1/4"	UD	-	80197	\$ 574 set
18 ft	1/4"	PD	80192	-	\$ 642 set
	1/4"	UD	-	80194	\$ 506 set
16 ft	1/4"	PD	80189	-	\$ 614 set
	1/4"	UD	-	80191	\$ 471 set
15 ft	1/4"	PD	80186	-	\$ 596 set
	1/4"	UD	-	80188	\$ 421 set
13 ft	1/4"	PD	80183	-	\$ 535 set
	1/4"	UD	-	80185	\$ 374 set

NOTE: SKID SHOES "A" AND "B" ARE UNDRILLED IN ALL KITS.

*PD = Predrilled, **UD = Undrilled

Hardware included = 10-16 Pound Rivets. Extra rivets can be purchased on page 149. End Shoes "A" and "B" use Nuts & Bolts.

Also available for easy installation:
May Wes Pound Rivet Tool
81320 \$ 40 ea



Learn more about May Wes Poly Skid Shoes

Scan the QR code with your smartphone to watch our FAQ video on YouTube.

PREMIUM POLY SKID SHOES - HARDWARE INCLUDED

**REPLACEMENT PARTS FOR GLEANER / MASSEY SERIES III
PRE-1987 - 1/4" THICK**

PREDRILLED & UNDRILLED

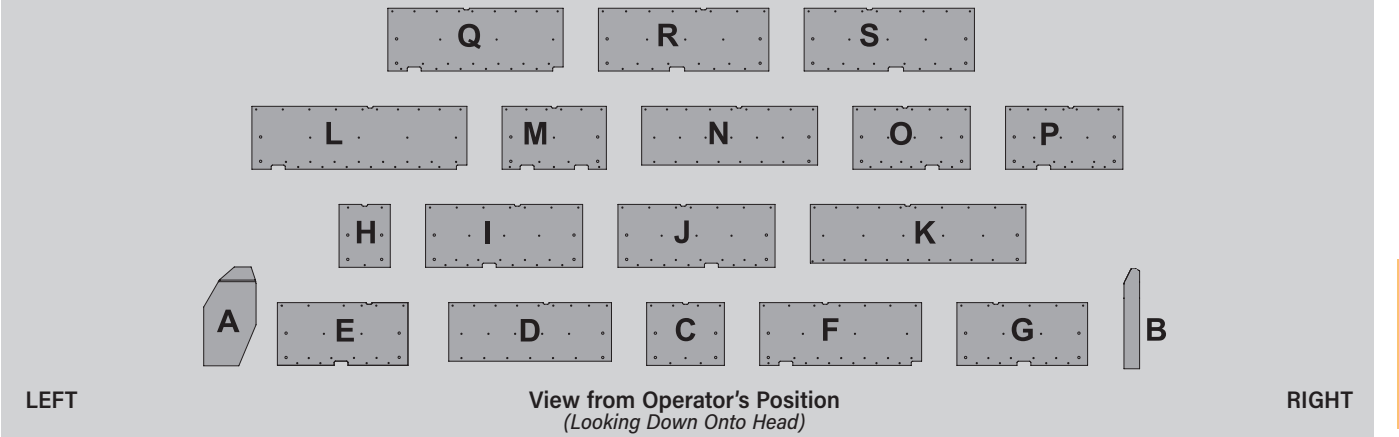

REPLACEMENT PARTS FOR GLEANER / MASSEY SERIES III - PRE-1987 - 1/4" THICK

DESCRIPTION	SHOE THICKNESS	PD*/UD**	PART NO LEFT - SILVER	PART NO RIGHT - SILVER	RETAIL PRICE	PART NO RIGHT - WHITE	RETAIL PRICE
49" x 14" End	1/4"	PD	(L) 40218	(K) 40030	\$ 186 ea	-	-
	1/4"	UD	-	-	-	40410	\$ 127 ea
40" x 14" End	1/4"	PD	(Q) 40380	(N) 40379	\$ 162 ea	-	-
	1/4"	UD	-	-	-	40408	\$ 119 ea
38 5/8" x 14"	1/4"	PD	(R) 40378	(S) 40377	\$ 156 ea	-	-
	1/4"	UD	-	-	-	40405	\$ 102 ea
37" x 14"	1/4"	PD	(D) 40382	(F) 40381	\$ 169 ea	-	-
	1/4"	UD	-	-	-	40406	\$ 106 ea
35 5/8" x 14"	1/4"	PD	(I) 40374	(J) 40373	\$ 135 ea	-	-
	1/4"	UD	-	-	-	40404	\$ 95 ea
29 5/8" x 14"	1/4"	PD	(E) 40372	(G) 40371	\$ 116 ea	-	-
	1/4"	UD	-	-	-	40403	\$ 81 ea
26 5/8" x 14"	1/4"	PD	(O) 40370	(P) 40369	\$ 102 ea	-	-
	1/4"	UD	-	-	-	40402	\$ 71 ea
23 5/8" x 14"	1/4"	PD	-	(M) 40368	\$ 90 ea	-	-
	1/4"	UD	-	-	-	40401	\$ 66 ea
17 5/8" x 14"	1/4"	PD	-	(C) 40367	\$ 68 ea	-	-
	1/4"	UD	-	-	-	40400	\$ 66 ea
11 5/8" x 14" End Shoe	1/4"	PD	-	(H) 40366	\$ 51 ea	-	-
	1/4"	UD	-	-	-	40399	\$ 34 ea
12" x 22 5/8"	1/4"	UD	(A) 42234	-	\$ 61 ea	-	-
5 1/2" x 18"	1/4"	UD	-	(B) 42194	\$ 35 ea	-	-
End Shoes Left - 12" x 22 5/8" Right - 5 1/2" x 18"	1/4"	UD	-	42195	\$ 84 pr	40174	\$ 83 ea

*PD = Predrilled, **UD = Undrilled

Hardware included = 10-16 Pound Rivets. Extra rivets can be purchased on page 149.

Parts 40346 (A), 40345 (B) and 40175 use Nuts & Bolts.



PREMIUM POLY SKID SHOES - HARDWARE INCLUDED

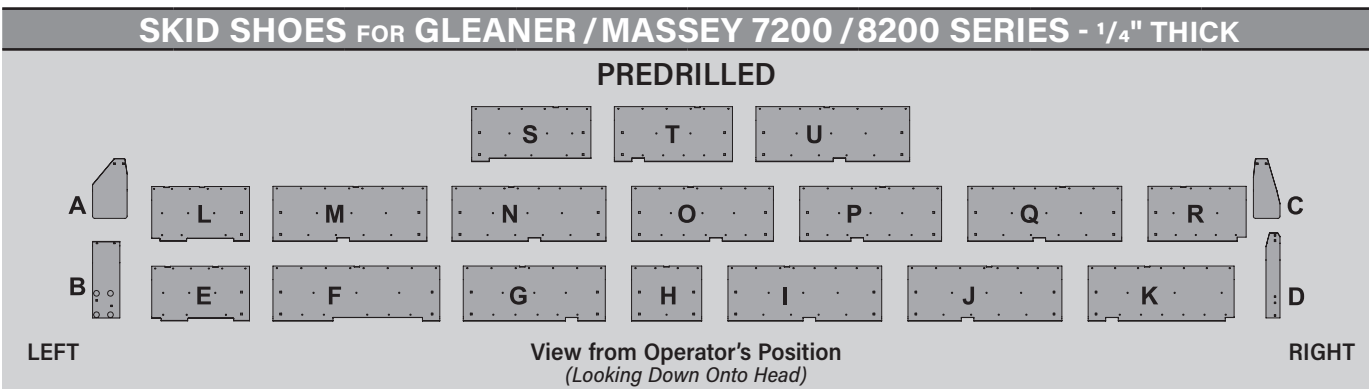

KITS FOR GLEANER / MASSEY 7200 / 8200 SERIES - 1/4" THICK

SET SIZE	SHOE THICKNESS	PD*	PART NO - SILVER	RETAIL PRICE
35 ft	1/4"	PD	83514	\$ 1272 set
30 ft	1/4"	PD	83513	\$ 1109 set
25 ft	1/4"	PD	83512	\$ 958 set
20 ft	1/4"	PD	83511	\$ 809 set

REPLACEMENT PARTS FOR GLEANER / MASSEY 7200 / 8200 SERIES - 1/4" THICK

DESCRIPTION	SHOE THICKNESS	PD*	SIZE	PART NO - SILVER	RETAIL PRICE
Left Divider Shoe	1/4"	PD	(A) 8 5/8" x 15 1/4"	42082	\$ 47 ea
Left End Shoe	1/4"	PD	(B) 6 3/4" x 20"	42083	\$ 38 ea
Right Divider Shoe	1/4"	PD	(C) 6 3/4" x 15 3/4"	42081	\$ 47 ea
Right End Shoe	1/4"	PD	(D) 3 1/2" x 21 3/8"	42084	\$ 35 ea
Skid Shoe	1/4"	PD	(E) 13" x 24 1/2"	42079	\$ 86 ea
Skid Shoe	1/4"	PD	(F) 13 7/8" x 42"	42093	\$ 149 ea
Skid Shoe	1/4"	PD	(G) 13 7/8" x 35 5/8"	42095	\$ 137 ea
Skid Shoe	1/4"	PD	(H) 13 7/8" x 17 5/8"	42089	\$ 79 ea
Skid Shoe	1/4"	PD	(I) 13 7/8" x 38 5/8"	42096	\$ 147 ea
Skid Shoe	1/4"	PD	(J) 13 7/8" x 38 5/8"	42097	\$ 147 ea
Skid Shoe	1/4"	PD	(K) 13 7/8" x 36 5/8"	42090	\$ 137 ea
Skid Shoe	1/4"	PD	(L) 13" x 24 5/8"	42080	\$ 87 ea
Skid Shoe	1/4"	PD	(M) 13 7/8" x 38 5/8"	42091	\$ 147 ea
Skid Shoe	1/4"	PD	(N) 13 7/8" x 38 5/8"	42087	\$ 147 ea
Skid Shoe	1/4"	PD	(O) 13 7/8" x 35 5/8"	42085	\$ 132 ea
Skid Shoe	1/4"	PD	(P) 13 7/8" x 35 5/8"	42086	\$ 132 ea
Skid Shoe	1/4"	PD	(Q) 13 7/8" x 38 5/8"	42088	\$ 147 ea
Skid Shoe	1/4"	PD	(R) 13 7/8" x 24 5/8"	42098	\$ 91 ea
Skid Shoe	1/4"	PD	(S) 13 7/8" x 30"	42077	\$ 97 ea
Skid Shoe	1/4"	PD	(T) 13 7/8" x 29 5/8"	42094	\$ 98 ea
Skid Shoe	1/4"	PD	(U) 13 7/8" x 38 5/8"	42092	\$ 149 ea

*PD = Predrilled
 Hardware included = 86 Small Head Pop Rivets.
 Extra rivets can be purchased on page 149.
 Parts 42082 (A), 42083 (B), 42081 (C) and
 42084 (D) use Nuts & Bolts.

Learn more
 about May Wes
 Poly Skid Shoes



Scan the QR code with your
 smartphone to watch our
 FAQ video on YouTube.



PREMIUM POLY SKID SHOES - HARDWARE INCLUDED

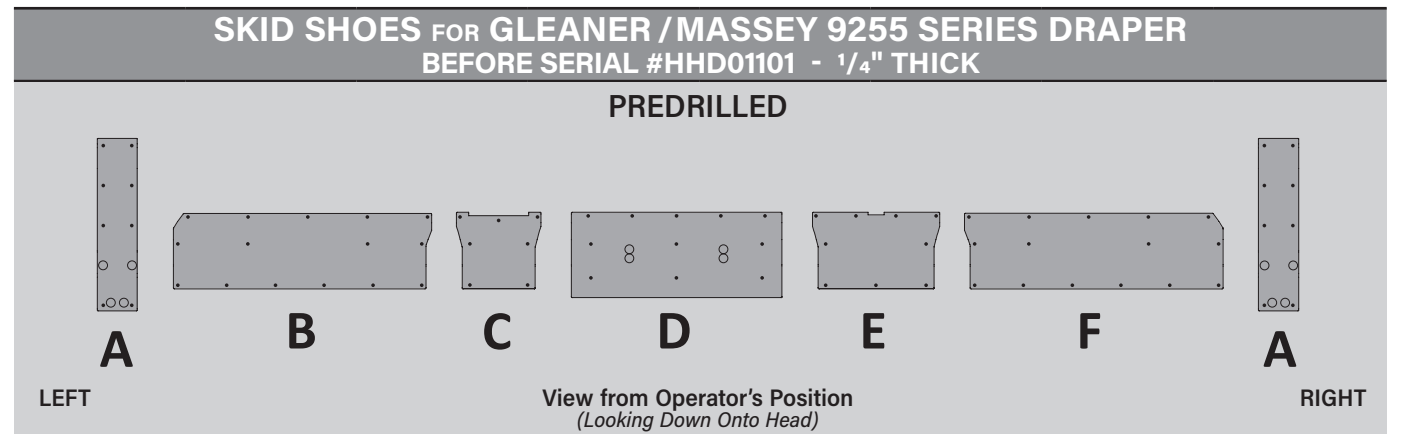

KITS FOR GLEANER / MASSEY 9255 - SERIAL # PRIOR TO HHD01101 - 1/4" THICK

SET SIZE	SHOE THICKNESS	PD*	PART NO - SILVER	RETAIL PRICE
40 ft	1/4"	PD	83681	\$ 1677 set
35 ft	1/4"	PD	83680	\$ 1471 set
30 ft	1/4"	PD	83679	\$ 1212 set
25 ft	1/4"	PD	83678	\$ 1030 set

REPLACEMENT PARTS FOR GLEANER / MASSEY 9255 - SERIAL # PRIOR TO HHD01101 - 1/4" THICK

DESCRIPTION	SHOE THICKNESS	PD*	SIZE	PART NO - SILVER	RETAIL PRICE
End Shoe	3/4"	PD	(A) 5 1/2" x 23 5/8"	42307	\$ 158 ea
Skid Shoe	1/4"	PD	(B) 10 3/8" x 35 5/8"	42305	\$ 125 ea
Skid Shoe	1/4"	PD	(C) 10 1/2" x 11 5/8"	42303	\$ 50 ea
Skid Shoe	1/4"	PD	(D) 11 3/4" x 29"	42306	\$ 124 ea
Skid Shoe	1/4"	PD	(E) 10 1/2" x 17 1/2"	42304	\$ 58 ea
Skid Shoe	1/4"	PD	(F) 10 3/8" x 35 5/8"	42302	\$ 125 ea

*PD = Predrilled
 Hardware included = 86 Small Head Pop Rivets. Extra rivets can be purchased on page 149. Part 42307 (A) uses M8 Bolts.



**No Grease or Mess.
 Saves Time and Money.**

BENEFITS INCLUDE:

- **NON-STICK POLY SURFACE**
 ELIMINATES NEED TO GREASE
- **PROLONG YOUR FIFTH WHEEL LIFE**
 DEBRIS WILL NOT STICK
- **LESS FRICTION FOR EASIER HANDLING**
 AND MANEUVERABILITY
- **BASIC INSTALLATION**
 ALL HARDWARE INCLUDED

Made in the U.S.A.

FIND IT ON PAGE 147

SLICKPLATE™
BY MINIMIZER™

PREMIUM POLY SKID SHOES - HARDWARE INCLUDED

SKID SHOES FOR AGCO 9255 SERIES DRAPER
AFTER SERIAL #HHD01101 STANDARD SKID - 1/4" THICK



PREDRILLED

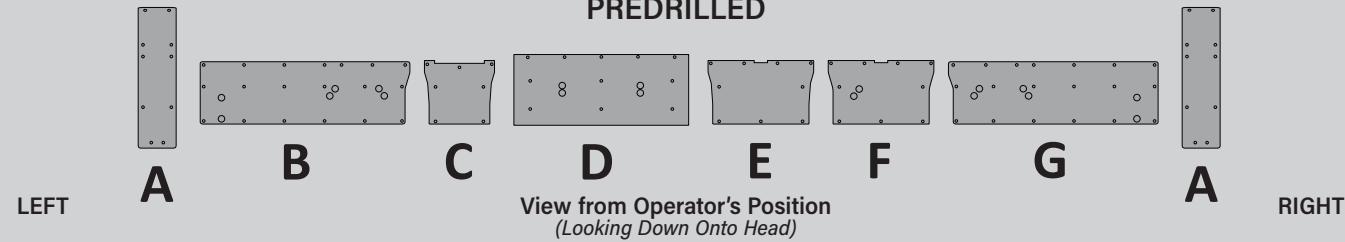

SET SIZE	SHOE THICKNESS	PD*	PART NO - SILVER	RETAIL PRICE
45 ft	1/4"	PD	83898	\$ 1875 set
40 ft	1/4"	PD	83897	\$ 1677 set
35 ft	1/4"	PD	83896	\$ 1471 set
30 ft	1/4"	PD	83895	\$ 1212 set
25 ft	1/4"	PD	83894	\$ 1030 set

DESCRIPTION	SHOE THICKNESS	PD*	SIZE	PART NO - SILVER	RETAIL PRICE
End Shoe	1/4"	PD	(A) 6 1/4" x 23 3/8"	42497	\$ 98 ea
Skid Shoe	1/4"	PD	(B) 10 3/8" x 34 3/4"	42498	\$ 120 ea
Skid Shoe	1/4"	PD	(C) 10 1/2" x 11 5/8"	42303	\$ 50 ea
Skid Shoe	1/4"	PD	(D) 11 3/4" x 29"	42306	\$ 124 ea
Skid Shoe	1/4"	PD	(E) 10 1/2" x 17 1/2"	42304	\$ 58 ea
Skid Shoe	1/4"	PD	(F) 10 1/2" x 17 1/2"	42499	\$ 57 ea
Skid Shoe	1/4"	PD	(G) 10 3/8" x 34 3/4"	42495	\$ 125 ea

*PD = Predrilled
Hardware included = 86 Small Head Pop Rivets. Extra rivets can be purchased on page 149.

PREMIUM POLY SKID SHOES - HARDWARE INCLUDED

SKID SHOES FOR AGCO 9255 SERIES DRAPER
AFTER SERIAL #HHD01101 LOW SKID - 1/4" THICK



PREDRILLED

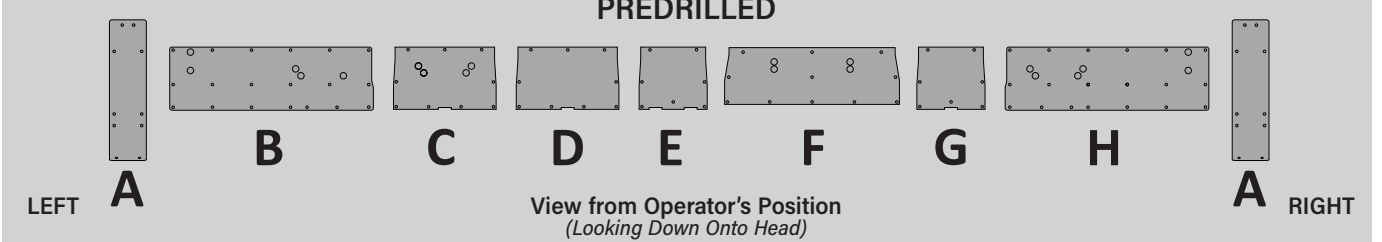

SET SIZE	SHOE THICKNESS	PD*	PART NO - SILVER	RETAIL PRICE
45 ft	1/4"	PD	83903	\$ 1875 set
40 ft	1/4"	PD	83902	\$ 1677 set
35 ft	1/4"	PD	83901	\$ 1471 set
30 ft	1/4"	PD	83900	\$ 1212 set
25 ft	1/4"	PD	83899	\$ 1030 set

DESCRIPTION	SHOE THICKNESS	PD*	SIZE	PART NO - SILVER	RETAIL PRICE
End Shoe	1/4"	PD	(A) 6 1/4" x 24"	43193	\$ 98 ea
Skid Shoe	1/4"	PD	(B) 10 3/4" x 34 3/4"	43194	\$ 120 ea
Skid Shoe	1/4"	PD	(C) 10 5/8" x 17 1/2"	43195	\$ 57 ea
Skid Shoe	1/4"	PD	(D) 10 5/8" x 17 5/8"	42099	\$ 56 ea
Skid Shoe	1/4"	PD	(E) 10 5/8" x 11 3/4"	42104	\$ 46 ea
Skid Shoe	1/4"	PD	(F) 9 3/4" x 29 15/16"	42101	\$ 124 ea
Skid Shoe	1/4"	PD	(G) 10 5/8" x 11 5/8"	42100	\$ 46 ea
Skid Shoe	1/4"	PD	(H) 10 3/4" x 34 3/4"	43196	\$ 125 ea

*PD = Predrilled
Hardware included = 86 Small Head Pop Rivets. Extra rivets can be purchased on page 149.
Part 43193 (A) uses Nuts & Bolts.

DU-HA® UNDER-SEAT STORAGE DEVICES

STORE YOUR GEAR OUT OF SIGHT

- Installs in Minutes
- Heavy Duty Construction
- Sized to Fit Your Make/Model

Visit maywes.com for available models and pricing.

CROP DIVIDERS

- Available in Red or Green
- Marker Rods Included

LEARN MORE ON PAGE 125

RIDE TAMER FOR ZERO-TURN MOWERS

Patented torsion suspension and trailing arm design provides significant ride improvement and reduces frame stress.

FIND IT ON PAGE 146

PREMIUM POLY SKID SHOES - HARDWARE INCLUDED

SKID SHOES FOR GLEANER / MASSEY 9250 SERIES DRAPER
SERIAL #CHD01101-FHD01100 HIGH PROFILE / AFTER SERIAL #FHD01101 HIGH PROFILE - 1/4" THICK

PREDRILLED

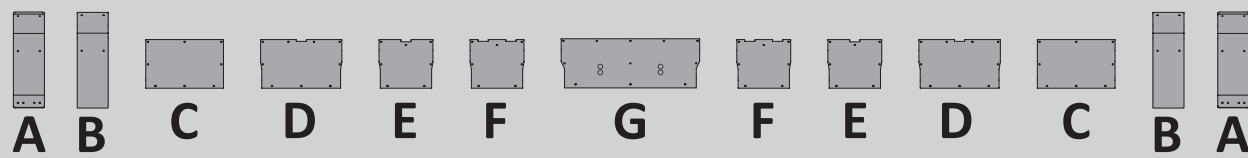

LEFT View from Operator's Position (Looking Down Onto Head) RIGHT

KITS FOR GLEANER / MASSEY 9250 SERIES DRAPER - SERIAL #CHD01101-FHD01100 - 1/4" THICK				
SET SIZE	SHOE THICKNESS	PD*	PART NO - SILVER	RETAIL PRICE
40 ft	1/4"	PD	83510	\$ 1428 set
35 ft	1/4"	PD	83509	\$ 1257 set
30 ft	1/4"	PD	83508	\$ 1087 set
25 ft	1/4"	PD	83507	\$ 925 set

KITS FOR GLEANER / MASSEY 9250 SERIES DRAPER - AFTER SERIAL #FHD01100 - 1/4" THICK				
SET SIZE	SHOE THICKNESS	PD*	PART NO - SILVER	RETAIL PRICE
40 ft	1/4"	PD	83575	\$ 1428 set
35 ft	1/4"	PD	83574	\$ 1257 set
30 ft	1/4"	PD	83573	\$ 1087 set
25 ft	1/4"	PD	83572	\$ 924 set

REPLACEMENT PARTS FOR GLEANER / MASSEY 9250 SERIES DRAPER - SERIAL #CHD01101 - FHD01100 & AFTER SERIAL #FHD01100 - 1/4" THICK					
DESCRIPTION	SHOE THICKNESS	PD*	SIZE	PART NO - SILVER	RETAIL PRICE
End Shoe	1/2"	PD	(A) 6 3/4" x 20 5/8"	42209	\$ 64 ea
End Shoe	1/4"	PD	(B) 6 3/4" x 20"	42075	\$ 42 ea
Skid Shoe	1/4"	PD	(C) 10 1/2" x 16 3/4"	42076	\$ 52 ea
Skid Shoe	1/4"	PD	(D) 10 1/2" x 17 9/16"	42071	\$ 57 ea
Skid Shoe	1/4"	PD	(E) 10 1/2" x 11 5/8"	42072	\$ 46 ea
Skid Shoe	1/4"	PD	(F) 10 1/2" x 11 5/8"	42073	\$ 46 ea
Skid Shoe	1/4"	PD	(G) 10 5/8" x 30"	42074	\$ 124 ea

*PD = Predrilled
Hardware included = 86 Small Head Pop Rivets. Extra rivets can be purchased on page 149.

SKID SHOE FOR HONEY BEE AIRFLEX / AIRFLEX SDX / RDX SERIES DRAPER

7 1/8" x 11 7/8" - Clips on, no hardware required.

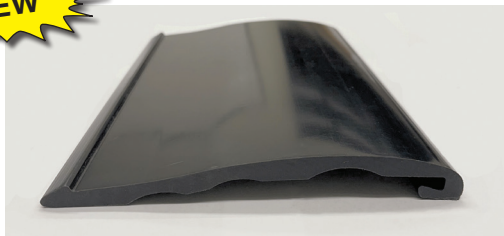

Fits Models:
Airflex
Airflex SDX
RDX

83920 - \$212 - 10 pk
23085 - \$22 - ea

Replaces OEM Part # 200589

PREMIUM POLY SKID SHOES - HARDWARE INCLUDED

SKID SHOES FOR GLEANER / MASSEY 9250 SERIES DRAPER
SERIAL #AHD01101-CHD01100 HIGH PROFILE - 1/4" THICK

PREDRILLED

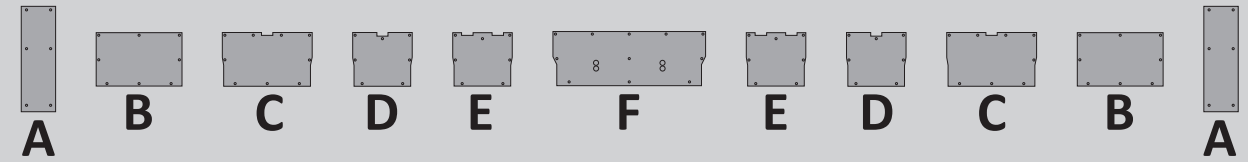

LEFT View from Operator's Position (Looking Down Onto Head) RIGHT

KITS FOR GLEANER / MASSEY 9250 SERIES DRAPER - SERIAL #AHD01101-CHD01100 - 1/4" THICK				
SET SIZE	SHOE THICKNESS	PD*	PART NO - SILVER	RETAIL PRICE
40 ft	1/4"	PD	83506	\$ 1428 set
35 ft	1/4"	PD	83505	\$ 1257 set
30 ft	1/4"	PD	83504	\$ 1088 set
25 ft	1/4"	PD	83503	\$ 924 set

REPLACEMENT PARTS FOR GLEANER / MASSEY 9250 SERIES DRAPER - SERIAL #AHD01101-CHD01100 - 1/4" THICK					
DESCRIPTION	SHOE THICKNESS	PD*	SIZE	PART NO - SILVER	RETAIL PRICE
End Shoe	1/4"	PD	(A) 6 3/4" x 20"	42102	\$ 42 ea
Skid Shoe	1/4"	PD	(B) 10 5/8" x 16 3/4"	42103	\$ 51 ea
Skid Shoe	1/4"	PD	(C) 10 5/8" x 17 5/8"	42099	\$ 56 ea
Skid Shoe	1/4"	PD	(D) 10 5/8" x 11 5/8"	42100	\$ 46 ea
Skid Shoe	1/4"	PD	(E) 10 5/8" x 11 3/4"	42104	\$ 46 ea
Skid Shoe	1/4"	PD	(F) 9 3/4" x 30"	42101	\$ 124 ea

*PD = Predrilled
Hardware included = 86 Small Head Pop Rivets. Extra rivets can be purchased on page 149.



AUGER TROUGH LINERS FOR GRAIN HEADS

DURABLE POLY WON'T RUST.
May Wes Auger Trough Liners cover the full length of the floor under the auger — not just the feed opening.

FIND THEM ON PAGE 117

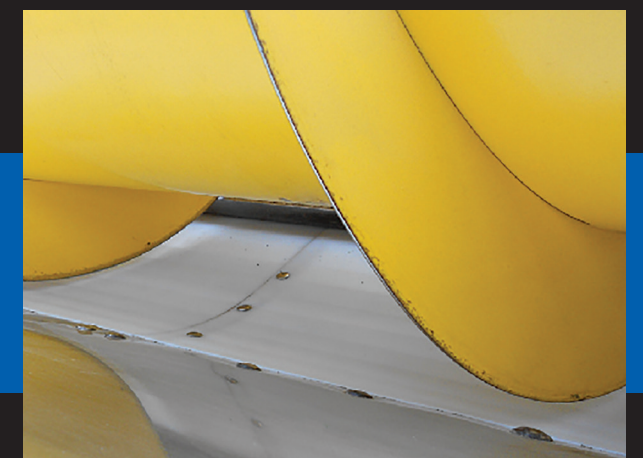



PREMIUM POLY SKID SHOES - HARDWARE INCLUDED

SKID SHOES FOR GLEANER / MASSEY 9250 SERIES DRAPER
 SERIAL #AHD01101-FHD01100 LOW PROFILE / AFTER SERIAL #FHD01101 LOW PROFILE - 1/4" THICK

PREDRILLED

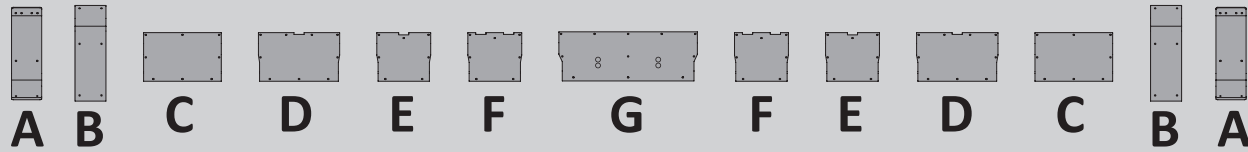

LEFT View from Operator's Position RIGHT
(Looking Down Onto Head)

KITS FOR GLEANER / MASSEY 9250 SERIES DRAPER - SERIAL #AHD01101-FHD01100 - 1/4" THICK

SET SIZE	SHOE THICKNESS	PD*	PART NO - SILVER	RETAIL PRICE
40 ft	1/4"	PD	83506	\$ 1428 set
35 ft	1/4"	PD	83505	\$ 1257 set
30 ft	1/4"	PD	83504	\$ 1088 set
25 ft	1/4"	PD	83503	\$ 924 set

KITS FOR GLEANER / MASSEY 9250 SERIES DRAPER - AFTER SERIAL #FHD01100 - 1/4" THICK

SET SIZE	SHOE THICKNESS	PD*	PART NO - SILVER	RETAIL PRICE
40 ft	1/4"	PD	83579	\$ 1428 set
35 ft	1/4"	PD	83578	\$ 1257 set
30 ft	1/4"	PD	83577	\$ 1087 set
25 ft	1/4"	PD	83576	\$ 924 set

REPLACEMENT PARTS FOR GLEANER / MASSEY 9250 SERIES DRAPER - SERIAL #AHD01101-FHD01100 & AFTER SERIAL #FHD01101 - 1/4" THICK

DESCRIPTION	SHOE THICKNESS	PD*	SIZE	PART NO - SILVER	RETAIL PRICE
End Shoe	1/2"	PD	(A) 6 3/4" x 20 5/16"	42210	\$ 64 ea
End Shoe	1/4"	PD	(B) 6 3/4" x 20"	42102	\$ 42 ea
Skid Shoe	1/4"	PD	(C) 10 5/8" x 16 3/4"	42103	\$ 51 ea
Skid Shoe	1/4"	PD	(D) 10 5/8" x 17 9/16"	42099	\$ 56 ea
Skid Shoe	1/4"	PD	(E) 10 5/8" x 11 5/8"	42100	\$ 46 ea
Skid Shoe	1/4"	PD	(F) 10 5/8" x 11 5/8"	42104	\$ 46 ea
Skid Shoe	1/4"	PD	(G) 9 3/4" x 30"	42101	\$ 124 ea

*PD = Predrilled
 Hardware included = 86 Small Head Pop Rivets. Extra rivets can be purchased on page 149.

Dynaflex Header Field Campaign:

A Field Campaign was announced in November 2011 for the Dynaflex Header Platform affecting the serial numbers listed below. This campaign updates the skid shoe configuration from a low profile to a high profile. **Please verify with an AGCO Dealer** if this change has been incorporated on your Dynaflex Head. If this change has been implemented, please order poly skid shoes for the following serial number break: CHD01101-FHD01100 High Profile (Page 89)

Serial Numbers Involved:

Model	Serial Range	Configuration
Challenger	FDH	Prior to AGCCFDH00BHD01514
Gleaner	9250	Prior to AGCR92500BHD01530
Massey Ferguson	9250	Prior to AGCM92500BHD01520

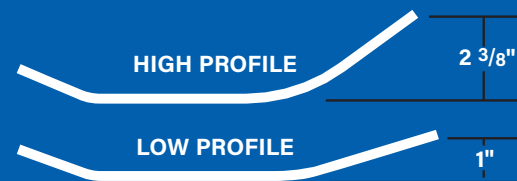

PREMIUM POLY SKID SHOES - HARDWARE INCLUDED

FOR JOHN DEERE DRAPER HEAD - 1/4" THICK - YELLOW

DESCRIPTION	SHOE THICKNESS	PD*	PART NO - YELLOW	RETAIL PRICE
Skid - 11 1/4" x 17 3/4"	1/4"	PD	41244	\$ 35 set

*PD = Predrilled Hardware included = Size 88 Small Head Pop Rivets. Extra rivets can be purchased on page 149.

SWATHER & HAYBINE POLY SKID SHOES

POLY FLOATS ACROSS THE DIRT WITHOUT BUILD-UP. THERE IS LESS PUSHING AND PILING OF MUD.

PROTECT DAMAGED METAL WITH POLY COVERING.

Poly fits over worn metal shoe and costs less than metal.

SKID SHOES FOR CASE IH (1988 & 1989 Haybines) & Hesston

DESCRIPTION	SIZE	PART NO	RETAIL PRICE
Case IH:	16" x 26 3/4"	80452	\$ 185 pr
- 8360 / 8370 / 8380 / 8830 / 8840			
Hesston:			
- 6650 / 8200 / 8400			
Case IH:	27" x 12"	80453	\$ 94 pr
- 8380 Middle Pad			
Hesston:			
- 8400 Middle Skid			

SKID SHOES FOR CASE IH WINDROWER

DESCRIPTION	SIZE	PART NO	RETAIL PRICE
Skid HDX 142 / 162 / 182	14 3/4" x 18 1/2"	41248	\$ 55 ea
Skid HDX 142 / 162 / 182	6" x 48"	41249	\$ 55 ea

SKID SHOES FOR NEW HOLLAND

DESCRIPTION	SIZE	PART NO	RETAIL PRICE
114	14" x 14"	80349	\$ 81 pr
114 / 116	14" x 12 3/4"	80360	\$ 81 pr
116	16" x 11 1/2"	80359	\$ 81 pr
469	14 1/2" x 11 1/2"	80357	\$ 81 pr
479	14 1/2" x 11 1/2"	80358	\$ 81 pr
489 / 499 / 1495 / 1496	13" x 13 1/2"	80363	\$ 77 pr
956	11" x 13 1/2"	80353	\$ 74 pr
1209 / 1219	20" x 15 1/2"	80356	\$ 128 pr
1600 - Predrilled	14 1/2" x 18 3/4"	81975	\$ 108 pr
1600 - Predrilled	14 3/4" x 19 3/4"	80398	\$ 120 pr
2280	14 3/4" x 28 1/2"	82058	\$ 156 pr

Note: Poly Skid Shoe does not replace OEM metal skid plate.

DISC MOWER & DISCBINE POLY SKID SHOES

SKID SHOES FOR NEW HOLLAND

DESCRIPTION	SIZE	PART NO	RETAIL PRICE
442 / 451 / 453 / 456 / 462 / 463 / 465 - Predrilled	13" x 13"	80460	\$ 37 ea
Inner Shoe	7 1/2" x 23"	80461	\$ 42 set
Extension Shoe	8" x 15"	80462	\$ 29 set
416 Disc Mower Shoe	9 1/2" x 18"	83657	\$ 42 set
Disc Mower Shoe - 1409 / 1410 / 1411 / 1412 / 1431 / 1432 / 1441 / 1442 / 615 / 616 / 617 / 2331 / 2332 / 2335 / 2355	8" x 13"	41246	\$ 28 set
Inner Shoe	8" x 27"	41487	\$ 36 set

SKID SHOES FOR KUHN

DESCRIPTION	SIZE	PART NO	RETAIL PRICE
GMD 600 / 700 - Predrilled	13" x 15 1/2"	80159	\$ 42 ea
Disc Mower Shoe	13" x 13"	80460	\$ 37 ea
GMD 600 / 700 Inner Shoe	7 1/2" x 23"	80461	\$ 42 ea
Heavy Duty Skid - Predrilled	12" x 20"	84873	\$ 57 ea
Fits OEM Part #56809120			

SKID SHOES FOR JOHN DEERE / EARLY NEW HOLLAND

DESCRIPTION	SIZE	PART NO	RETAIL PRICE
Disc Mower - Predrilled	13" x 13"	80460	\$ 37 set
Inner Shoe	7 1/2" x 23"	80461	\$ 42 set
JD 275 Disc Mower	12" x 16"	82486	\$ 42 set

SKID SHOES FOR KRONE

DESCRIPTION	SIZE	PART NO	RETAIL PRICE
0003 AM323-5	10 1/2" x 17"	82227	\$ 39 ea
Disc Mower - Predrilled	13" x 13"	80460	\$ 37 ea
AM 282 - Predrilled	11 1/2" x 13"	81360	\$ 50 ea
EC 4013 - Predrilled	11" x 16 3/4"	41578	\$ 50 ea

Note: Poly Skid Shoe does not replace OEM metal skid plate.



GRAIN TANK AUGER TROUGH LINERS - 1/8" THICK



- Save Money on Grain Tank Floor Repair
- Protect the High-Wear Areas in Your Grain Tank
- Prevent Grain Loss

FOR NEW HOLLAND		
PART NO	DESCRIPTION	RETAIL PRICE
82799	All single auger TR models	\$ 284 kit
83399	CR920 / CR940 / CR960 / CR970 / CR980 / CR8080 / CR9040 / CR9060 / CR9070	\$ 567 kit

FOR JOHN DEERE (Covers Both Augers)		
PART NO	DESCRIPTION	RETAIL PRICE
83327	9660 STS / 9760 STS / 9860 STS / 9670 STS / 9770 STS / 9870 STS / S550 STS / S660 STS / S670 STS / S680 STS / S690 STS	\$ 515 kit
83199	9560 STS / 9570 STS / 9650 STS / 9750 STS	\$ 515 kit
82584	9450 / 9550 / 9560 / 9600 / 9610 / 9650 / 9660	\$ 557 kit
82583	9400 / 9410 / 9500 / 9510	\$ 557 kit

FOR GLEANER (Single Auger)		
PART NO	DESCRIPTION	RETAIL PRICE
82642	All models	\$ 284 kit

UNIVERSAL KIT (Single Auger) - 16" x 10'		
PART NO	DESCRIPTION	RETAIL PRICE
82909	Universal Grain Tank Auger Liner	\$ 284 kit

REPLACEMENT PARTS		
PART NO	DESCRIPTION	RETAIL PRICE
22147	2" x 24" x 15° Bent Stainless Steel Strap	\$ 37 ea
22439	2" x 24" x 40° Bent Stainless Steel Strap	\$ 37 ea

FOR CASE IH (Covers Both Augers)		
PART NO	DESCRIPTION	RETAIL PRICE
83313	7230 / 7240 / 7250 / 8230 / 8240 / 8250 / 9230 / 9240 / 9250	\$ 515 kit
83383	5088 / 6088 / 7088 / 5130 / 6130 / 7130 / 7140	\$ 515 kit
83311	7010 / 8010 / 7120 / 8120 / 9120	\$ 567 kit
82582	All 2300 & 2588 Series	\$ 510 kit
82581	All 2100 Series	\$ 510 kit
82580	All 1600 Series (Except 1620)	\$ 510 kit
82579	All 1400 Series	\$ 510 kit

AUGER BED LINERS

FOR CASE IH		
PART NO	DESCRIPTION	RETAIL PRICE
84884	1440 / 1460 / 1470 / 1640 / 1644 / 1660 / 1666 / 2144 / 2166 / 2344 / 2366 - (4 Auger)	\$ 691 kit
84885	1480 / 1680 / 1688 / 2188 / 2377 / 2388 / 2577 / 2588 / 5088 / 6088 / 7088 / 5130 / 6130 / 7130 - (5 Auger)	\$ 824 kit
84886	Case IH Single Auger Bed Liner Kit (fits all models listed above)	\$ 176 kit

FOR JOHN DEERE		
PART NO	DESCRIPTION	RETAIL PRICE
84887	9670 STS / 9770 STS / 9860 STS / 9870 STS / 9880 STS / S650 / S660 / S670 / S680 / S690 / S760 / S770 / S780 / S790 - (4 Auger)	\$ 567 kit
84888	John Deere Single Auger Bed Liner Kit (fits all models listed above)	\$ 150 kit

SAVE \$\$\$ ON AUGER TROUGH REPAIR

- INCLUDES:
- 1/8" UHMW Liner
 - Stainless Steel Fastening Strips
 - Shims
 - Pop Rivets



DO YOU NEED PROTECTION FOR YOUR AUGER FLIGHTING, TOO?

Find Auger Wearshoes on pages 126-132



UNIVERSAL AUGER TUBE LINER

Universal Auger Tube Liners include UHMW liner, splice strip, test strip for measuring true diameter and self-tapping screws and pop rivets. To order, you will need to know the inside diameter and length of kit needed. Liner kits may be stacked to cover longer auger tubes. **Not compatible with folding tubes.**

As Featured by Larson Farms
[youtube.com/LarsonFarms](https://www.youtube.com/LarsonFarms)



Includes 1/8" UHMW Liner, Splice Strip, Self-Tapping Screws & Pop Rivets, Test Strip for Measuring True Diameter



COMPLETE KIT				
PART NO	DESCRIPTION	LENGTH	RETAIL PRICE	
83803	10" Diameter Universal Tube Liner	8 ft kit	\$ 258	ea
83804	12" Diameter Universal Tube Liner	8 ft kit	\$ 284	ea
83805	14" Diameter Universal Tube Liner	8 ft kit	\$ 309	ea
83806	10" Diameter Universal Tube Liner	4 ft kit	\$ 165	ea
83807	12" Diameter Universal Tube Liner	4 ft kit	\$ 176	ea
83808	14" Diameter Universal Tube Liner	4 ft kit	\$ 191	ea
83809	16" Diameter Universal Tube Liner	4 ft kit	\$ 206	ea
83810	18" Diameter Universal Tube Liner	4 ft kit	\$ 222	ea
83811	20" Diameter Universal Tube Liner	4 ft kit	\$ 237	ea
83812	22" Diameter Universal Tube Liner	4 ft kit	\$ 248	ea
83813	24" Diameter Universal Tube Liner	4 ft kit	\$ 263	ea

TANK FILL/BUBBLE UP TUBE LINERS - 1/8" THICK

PREVENTS CORROSION & WEAR

Tube liners extend the life of your auger tubes and provide a full poly surface when matched with auger wearshoes.

All Hardware is included.

Scan the QR code with your smartphone to watch our installation video.



FOR CASE IH		
PART NO	DESCRIPTION	RETAIL PRICE
83702	for Case IH Tank Fill - 1660 / 1666 / 1688 / 2144 / 2166 / 2188 / 2344 / 2366 / 2377 / 2388 / 2577 / 2588	\$ 124 ea
83800	for Case IH Tank Fill Tube Liner - 5088 / 6088 / 7088 / 5130 / 6130 / 7130 / 5140 / 6140 / 7140	\$ 150 ea
83825	for Case IH Tank Fill - 7010 / 7120 / 7140 / 7230 / 7240 / 8010 / 8120 / 8230 / 8240 / 8250 / 9120 / 9230 / 9240	\$ 124 ea

FOR NEW HOLLAND		
PART NO	DESCRIPTION	RETAIL PRICE
83658	for New Holland Upper Tank Fill - CR920 / CR940 / CR960 / CR970 / CR9040 / CR9060 / CR9070 / CR9080	\$ 88 ea
83667	for New Holland Lower Tank Fill - CR920 / CR940 / CR960 / CR970 / CR9040 / CR9060 / CR9070 / CR9080	\$ 124 ea

FOR JOHN DEERE		
PART NO	DESCRIPTION	RETAIL PRICE
83666	for John Deere Tank Fill - 11.66" ID, 44.81" Length - 9770 STS / 9870 STS	\$ 124 ea
83669	for John Deere Tank Fill - 11" ID, 45.2" Length - 9450 / 9550 / 9650 / 9650 CTS / 9560 / 9660 / 9660 CTS (Note: Will not fit 9560 STS, 9650 STS or 9660 STS.)	\$ 124 ea
83682	for John Deere Tank Fill - 11.71" ID, 53" Length - S670 (High Capacity) / S680 / S690 / S770 (High Capacity) / S780 / S790	\$ 140 ea
83801	for John Deere Tank Fill Tube Liner - 11" ID, 45" Length - 9650 STS / 9750 STS / 9660 STS / 9670 STS / 9760 STS / 9860 STS / S650 / S660 / S670 (Reg. Capacity) / S760 / S770 (Reg. Capacity)	\$ 140 ea

CHAFF SPREADERS FOR CASE IH 1400-2500 SERIES

Flat Arm for Chaff Pan



Pre-load Plate



Chaff Pan Cover (Bubble Pan shown)

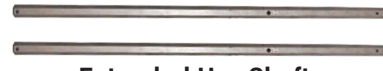

Extended Hex Shafts



Bottom Discs, Drums & Spreader Bats



Chaff Spreader Kit example shown above. Kits include Sieve Easy Adjust Kit (page 98).

HIGH PEAK DIVERTS CHAFF TO EACH SPREADER.

Spread chaff over a 16 foot area

Eliminates two rows of chaff bed your plow will have to cut through in the future. Spreading the chaff evenly helps break down compost material quicker. These dual spreaders work well on both corn & bean debris. There are no hydraulic motors to tap into the hydraulic lines that rob your combine of power.



CHAFF SPREADER - COMPLETE UNIT

PART NO	DESCRIPTION	RETAIL PRICE
82004	2188 /2388 /2588	\$ 819 ea
80556	Extended Sieve - 1680 /1688	\$ 819 ea
82003	2144 /2166 /2344 /2366	\$ 819 ea
80547	Extended Sieve - 1644 /1666	\$ 819 ea
80548	1480 /1680	\$ 799 ea
80546	1440 /1460 /1470 /1640 /1660	\$ 799 ea

Kits Include: Two Chaff Spreaders, Extended Shafts, Chaff Pan Cover, Sieve Easy Adjust Kit and Mounting Hardware.

May Wes Chaff Spreaders are not interchangeable with Case IH Chaff Spreaders.

CHAFF SPREADER - REPLACEMENT PARTS

PART NO	DESCRIPTION	SIZE	RETAIL PRICE
40074	Bottom Disc - 1420 /1480 /1620 / 1680	30"	\$ 83 ea
40073	Bottom Disc - 1440 /1460 /1640 /1660	24"	\$ 76 ea
40138	Drum (12") Tube	12"	\$ 71 ea
40040	Extended Hex Shaft	32 3/8"	\$ 88 ea
40360	5/16" x 14" Ready Rod (Need 6 for Each Drum)	5/16" x 14"	\$ 15 ea
40361	Spreader Bats (Need 6 for Each Drum)	11 5/8"	\$ 20 ea
80560	Spreader Bats - 6 pack	11 5/8"	\$ 85 ea
40358	Metal Square - Pre-Load Plate	4" x 4"	\$ 21 ea
40359	Flat Arm for Chaff Pan Add-on for Shaking Pan	3" x 10"	\$ 22 ea

CHAFF PAN COVER

Flat Pan (May use without May Wes Chaff Spreader)

PART NO	DESCRIPTION	SIZE	RETAIL PRICE
40166	1480 /1680	31" x 51"	\$ 132 ea
40165	1420 /1440 /1460 /1620 /1640 /1660	32" x 43"	\$ 100 ea

Bubble Pan (Included in Chaff Spreader Unit)

PART NO	DESCRIPTION	SIZE	RETAIL PRICE
40171	Bracket to Lift Pan - Extended Sieve 1680 /1688 /2188 /2388 /2588		\$ 81 ea
40170	1680 /1688 Extended Sieve Pan Only 2188 /2388 /2588	24" x 61"	\$ 132 ea
40169	Extended Sieve Pan Only - 1644 /1666 /2144 /2166 /2344 /2366	24" x 48"	\$ 116 ea
40168	1480 /1680	31" x 51"	\$ 132 ea
40167	1440 /1460 /1640 /1660	32" x 43"	\$ 117 ea

Custom Pan

PART NO	DESCRIPTION	RETAIL PRICE
40315	Special Pan for Other Combine Models (specify size)	\$ 154 ea

To ensure that the Chaff Spreader fits between the axles, please measure before ordering.

Standard axles are 92" - 120"

The Chaff Spreader will not fit axles that measure between 67" and 90"

CLEAN OUT DOORS



FOR CASE IH CLEAN GRAIN ELEVATOR DOORS

PART NO	DESCRIPTION	SIZE	RETAIL PRICE
42388	1680 /1682 /1688 /2188 /2377 /2388 /2577 /2588	9"	\$ 162 kit
42389	1640 /1644 /1660 /1666 /1670 /2144 /2166 /2344 /2366	7"	\$ 147 kit
42390	7010 /7120 /7230 /8010 /8120 /8230 /9120 /9230	10"	\$ 252 kit
42391	5088 /6088 /7088 (Before Serial #Y9002404)	9"	\$ 205 kit
42392	5088 /5130 /6088 /6130 /7088 /7130 (After Serial # Y9002404)	10"	\$ 212 kit

FOR JOHN DEERE CLEAN GRAIN ELEVATOR DOORS

PART NO	DESCRIPTION	SIZE	RETAIL PRICE
42378	9400 /9410 /9500 /9510	8"	\$ 132 kit
42379	9600 /9610	10"	\$ 149 kit
42380	9450 /9550 /9650 /9750 /9560 /9660 /9760 /9860 /9570 /9670 /9770 /9870 /S550 /S660 /S670 /S680 /S690	11"	\$ 169 kit

IMPROVES CROP FLOW BY ELIMINATING DIRT BUILDUP.

UHMW construction gives you a long lasting, slick and durable replacement for your rusted and worn out steel doors.



SEED FLOW SENSOR IMPACT WEAR PLATE FOR JOHN DEERE



ECONOMICAL REPLACEMENT COMPARED TO PURCHASING THE ENTIRE OEM ASSEMBLY

May Wes engineering working in conjunction with a valued customer developed a replacement poly plate for the mass seed flow sensor on John Deere combines. These products offer economical replacement parts compared to the alternative option of purchasing the entire OEM assembly.

PART NO	DESCRIPTION	RETAIL PRICE
42318	10 5/8" x 20 1/4" x 1/8" Thick Poly Plate Models Include: S-Series	\$ 35 ea
41946	8 1/4" x 12 1/2" x 1/8" Thick Poly Plate Models Include: 9450 /9550 /9550 SH /9650 /9650 CTS /9650 STS /9750 STS /9560 /9560 SH /9560 STS /9660 /9660 CTS /9660 STS /9760 STS /9860 STS /9570 STS /9670 STS /9770 STS /9870 STS	\$ 35 ea
42198	5 1/4" x 12 7/8" x 1/8" Thick Poly Plate Models Include: 9400 /9500 /9410 /9510	\$ 35 ea

Plates come pre-drilled and hardware is included.

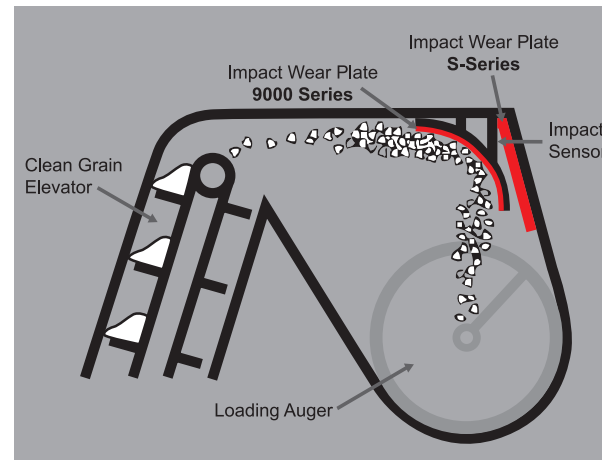



FEEDERHOUSE SILENCER KITS FOR CASE IH

REDUCE THE RATTLE AND CLATTER OF METAL ON METAL, GRAIN ON METAL & CHAIN ON METAL

Kits include: Throat liner, drum guards, rails and top sprocket stripper plates.



THROAT LINING

Grain feeds into combine over the slick poly and helps prevent bunching in the throat. The poly does not corrode like metal and provides a smooth surface, even when placed over corroded metal. The echo from the metal on the bottom is absorbed by the poly lining, which is form-fitted to cover the existing metal.

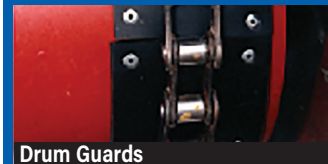

DRUM GUARDS

Soft plastic, rubber-like material is used to cover the metal drum where the chain hits. Saves the chain from excessive wear on the drum and decreases noise.



RAILS

Cover existing metal rails with poly rails. This helps prevent clattering of metal on metal as the bars on the feederhouse chain hit the metal rails. Poly rails cushion the impact of metal for less wear on rails and bars.



TOP SPROCKET STRIPPER PLATES

As the chain goes around the metal plate, it wears grooves into the metal and flattens the bottom of the chain. With poly plates, the chain glides across the poly and helps retain the shape of the chain. The chain will not clang against poly as it does the metal. Replace metal stripper plates with poly plates.

COMPLETE KIT

PART NO	DESCRIPTION	FEEDER HOUSE DEPTH	RETAIL PRICE
82071	3 Strand Kit - 2188 /2388 /2588	54"	\$ 786 kit
82072	3 Strand Kit - 2188 /2388 /2588	60"	\$ 836 kit
81750	1480 /1680 /1688 /2188 /2388 /2588	60"	\$ 743 kit
82069	2144 /2166 /2344 /2366	60"	\$ 743 kit
81751	1420 /1440 /1460 /1620 /1640 /1660 /Z666 /2144 /2166 /2344 /2366	54"	\$ 688 kit
81752	1480 /1680 /1688 /2188 /2388 /2588	54"	\$ 688 kit
81753	1420 /1440 /1460 /1620 /1640 /1660	47"	\$ 688 kit

PART NO: 1440 (Ser. # 10,001 & Up) 1460 (Ser. # 12,001 & Up)
1480 (Ser. # 14,001 & Up) 1600 Series & Up

NOTE: Not compatible with field tracker.

INDIVIDUAL PARTS

Throat Liner - Not compatible with field tracker.

PART NO	DESCRIPTION	SIZE	FEEDER HOUSE DEPTH	RETAIL PRICE
40596	1480 /1680 /168 /2188 /2388 /2588	-	60"	\$ 539 ea
41088	2144 /2166 /2344 /2366	-	60"	\$ 544 ea
40597	1480 /1680 /1688 /2188 /2388 /2588	-	54"	\$ 495 ea
40598	1420 /1440 /1460 /1620 /1640 /1660 /1666 /2144 /2166 /2344 /2366	-	54"	\$ 483 ea
40599	1420 /1440 /1460 /1620 /1640 /1660	-	47"	\$ 483 ea
40548	15' Throat Liner Sealant Tape Roll	1/8" x 1"	-	\$ 28 ea

Drum Guard

PART NO	DESCRIPTION	SIZE	FEEDER HOUSE DEPTH	RETAIL PRICE
40005	Rock (recessed) or Smooth Drum Guard	3" x 31"	-	\$ 112 pr
40918	3 Strand Drum Guard Assembly - 3 Piece Set	3" x 31"	-	\$ 167 set
41030	4" x 31" Drum Guard - Undrilled	4" x 31"	-	\$ 118 pr



FEEDERHOUSE SILENCER FOR CASE IH - INDIVIDUAL PARTS

INDIVIDUAL PARTS

Rail Guide				
PART NO	DESCRIPTION	SIZE	FEEDER HOUSE DEPTH	RETAIL PRICE
40007	Rail Guide - 1400 Series - 2588 Series (please specify)	39"	47" - 54"	\$ 93 pr
40023	Rail Guide - 1400 Series - 2588 Series (please specify)	45"	60"	\$ 93 pr
Top Sprocket Stripper Plate				
PART NO	DESCRIPTION	SIZE	FEEDER HOUSE DEPTH	RETAIL PRICE
40009	• 1440 (ser. # up to 10,000) • 1480 (ser. # up to 14,000) • 1460 (ser. # up to 12,000)	-	4 1/2" x 8"	\$ 86 pr
40010	• 1440 (ser. # 10,001 & up) • 1480 (ser. # 14,001 & up) • 1460 (ser. # 12,001 & up) • 1640 /1660 /1680 /2166 /2188 /2388 /2588	-	7 1/4" x 6 1/2"	\$ 86 pr
41503	3 Strand Top Sprocket Stripper Plate - 3 Piece Set	-	7 1/4" x 6 1/2"	\$ 129 set
40674	Top Sprocket Stripper Plate (Middle)	-	6 1/8" x 6 5/8"	\$ 47 ea

SIEVE EASY ADJUST KIT FOR CASE IH



NO MORE TIGHT QUARTERS...

Adjust sieve from outside of combine.

A simple and easy way to adjust the top and bottom sieve of your combine from the outside instead of crawling inside to manually adjust with tools.

PART NO	DESCRIPTION	RETAIL PRICE
81560	2188 /2388 /2588 ext.	\$ 284 kit
81555	2144 /2166 ext., 2344, 2366 ext.	\$ 284 kit
81533	1680 /1688 ext.	\$ 284 kit
81532	1644 /1666 ext.	\$ 284 kit
81531	1480 /1680	\$ 258 kit
81530	1440 /1460 /1640 /1660	\$ 258 kit
81529	1420 /1620	\$ 258 kit

POLY CHAIN GUIDES FOR JOHN DEERE

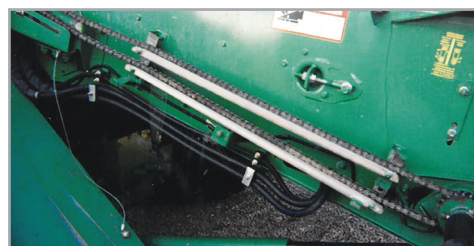

SAVES MONEY, LASTS LONGER.

Replace factory wood feederhouse throat chain guide with a May Wes Poly Chain Guide.

PART NO	DESCRIPTION	SIZE	RETAIL PRICE
82042	2-Hole - 9400 /9410 /9500 /9510 /9600 /9610	36 7/8"	\$ 82 pr
82043	3-Hole - 4400 /4420 /6600 /6620 /7700 /7720 /8800 /8820	37 1/2"	\$ 82 pr

CLEAN GRAIN ELEVATOR POLY PADDLES

MAY WES POLY PADDLES OUTPERFORM FACTORY RUBBER & STEEL PADDLES

Rigid elevator poly paddles do not bend back like rubber, which allows grain to fall back down the elevator. (see illustrations on right)

Extend the life of your elevator tin.

As the Poly Paddles move through the elevator, they leave a protective coating, reducing friction and wear.

- For Clean Grain Elevators
- Replacement Parts; Paddles & Chains
- Complete Kits of Paddles with the Chain
- 1/4" Thick (Unless Specified)

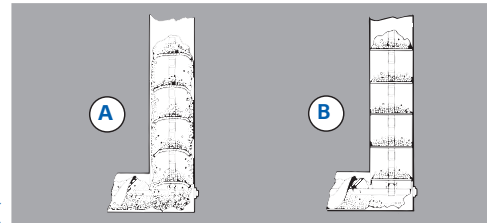

A. Grain flow with factory rubber paddles.
B. Grain flow with May Wes poly paddles installed.

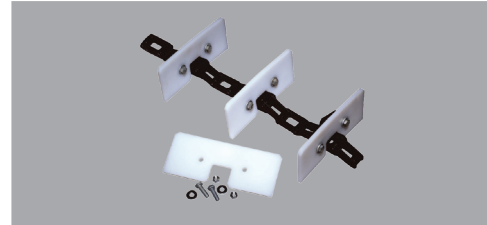

FOR CASE IH

DESCRIPTION	PADDLE WITH CHAIN		NO OF PADDLES ON CHAIN	PADDLE ONLY FOR		RETAIL PRICE
	PART NO	RETAIL PRICE		MW CHAIN PART NO	OEM CHAIN PART NO	
7010 / 8010 / 7120 / 8120 / 9120 / 7230 / 8230 / 9230 - 3/8" Thick	83181	\$ 1417 kit	35	41745	41745	\$ 14 ea
1680 / 1688 / 2188 / 2377 / 2388 / 2577 / 2588 / 5088 / 6088 / 7088 / 5130 / 6130 / 7130 / 2588 / 5088 / 6088 / 7088 / 5130 / 6130 / 7130	80994	\$ 1092 kit	38	40514	40513	\$ 11 ea
*After 1980 Rice machine needs 42 paddles.						
1640 / 1660 / 1666 / 2144 / 2166 / 2344 / 2366	80995	\$ 1072 kit	38	40512	40512	\$ 9 ea
1420 / 1620	80998	\$ 1015 kit	38	40511	40511	\$ 9 ea

FOR NEW HOLLAND

DESCRIPTION	PADDLE WITH CHAIN		NO OF PADDLES ON CHAIN	PADDLE ONLY FOR		RETAIL PRICE
	PART NO	RETAIL PRICE		MW CHAIN PART NO	OEM CHAIN PART NO	
CR920 / CR940 / CR960 / CR970 / CR980 / CR9040 / CR9060 / CR9065 / CR9070 / CR9080 / R6090 / CR7090 / CR8080 / CR8090 / CR9090 - 3/8" Thick	-	-	37	-	41501	\$ 14 ea
TR89 / TR95 / TR96 / TR97 / TR98	81011	\$ 922 kit	20	40533	40533	\$ 9 ea
TR75 / TR85 / TR86 / TR87 / TR88	81010	\$ 861 kit	19	40533	40533	\$ 9 ea
TR70 (Ser. # 215983 and up)	81010	\$ 861 kit	19	40533	40533	\$ 9 ea

FOR JOHN DEERE

DESCRIPTION	PADDLE WITH CHAIN		NO OF PADDLES ON CHAIN	PADDLE ONLY FOR		RETAIL PRICE
	PART NO	RETAIL PRICE		MW CHAIN PART NO	OEM CHAIN PART NO	
S690 STS - 3/8" Thick	-	-	36	41991	41991	\$ 14 ea
9770 STS / 9870 STS / S670 STS (High Capacity) / S670 Hillmaster / S680 STS / S680 Hillmaster / S690 Hillmaster - 3/8" Thick	-	-	34	41846	41846	\$ 14 ea
9650 STS / 9750 STS / 9560 STS / 9660 STS / 9760 STS / 9860 STS / 9570 STS / 9670 STS / S550 STS / S660 STS / S670 STS (Reg. Capacity) - 3/8" Thick	-	-	34	41262	41262	\$ 14 ea
9450 / 9550 / 9550 SH / 9650 / 9650 CTS / 9560 / 9560 SH / 9660 / 9660 CTS - 3/8" Thick	-	-	33	41262	41262	\$ 14 ea
9600 (Ser. # 670301 & up)	-	-	36	40505	40505	\$ 11 ea
9600 / 9610	81016	\$ 1072 kit	35	40505	40505	\$ 11 ea
9400 / 9500 / 9510 / CTS2	81015	\$ 1051 kit	35	40504	40504	\$ 11 ea
8820 - Sweco	81014	\$ 1123 kit	42	40503	40503	\$ 9 ea
8820 (Ser. # 464351 & up)	81013	\$ 917 kit	28	40503	40503	\$ 9 ea
8820 (Ser. # up to 464350)	81019	\$ 907 kit	28	40502	40502	\$ 8 ea
6600 / 6601 / 6620 / 7700 / 7701 / 7720	81018	\$ 845 kit	27	40502	40502	\$ 8 ea
3300 / 4400 / 4420	81017	\$ 824 kit	25	40501	40501	\$ 9 ea

FOR GLEANER

DESCRIPTION	PADDLE WITH CHAIN		NO OF PADDLES ON CHAIN	PADDLE ONLY FOR		RETAIL PRICE
	PART NO	RETAIL PRICE		MW CHAIN PART NO	OEM CHAIN PART NO	
S67 / S68 / S77 / S78 / S88	-	-	37	-	42106	\$ 10 ea
R55 / R65 / R66 / R75 / R76	83349	\$ 1206 kit	37	41267	41266	\$ 10 ea
R62 / R72 / R42 (Ser. #43001-48001) / R52 (Ser. #53001-98001)	82074	\$ 1159 kit	36	41267	41266	\$ 10 ea
N5 / N6 / N7 / R5 / R6 / R7 / R60 / R70	80989	\$ 1195 kit	34	40524	40523	\$ 9 ea
L2 / L3 / M2 / M3 / R40 / R50 / R42 (Before Ser. #43001) / R52 (Before Ser. #53001)	80990	\$ 1206 kit	37	40522	40521	\$ 9 ea
L / M	80988	\$ 1103 kit	32	40520	40519	\$ 9 ea

All parts are 1/4" thick unless specified.

CLEAN GRAIN ELEVATOR POLY PADDLES

FOR MASSEY FERGUSON

DESCRIPTION	PADDLE WITH CHAIN		NO OF PADDLES ON CHAIN	PADDLE ONLY FOR		RETAIL PRICE
	PART NO	RETAIL PRICE		MW CHAIN PART NO	OEM CHAIN PART NO	
9790	82262	\$ 1226 kit	37	41267	41266	\$ 10 ea
9520 / 9540 / 9560	-	-	37	-	42106	\$ 10 ea
8570 / 8780	83661	\$ 1154 kit	37	40530	40530	\$ 9 ea
8560	83660	\$ 1170 kit	38	40530	40530	\$ 9 ea
860 (Ser. # 19544 & up)	-	-	38	40527	40527	\$ 9 ea
760	-	-	41	40527	40527	\$ 9 ea
850 (Ser. # 1696027544 & up)	-	-	41	40527	40527	\$ 9 ea
850 (Ser. # up to 1696027543)	81001	\$ 1185 kit	37	40527	40527	\$ 9 ea
750	81001	\$ 1185 kit	37	40527	40527	\$ 9 ea
550 (Ser. # 236302121 & up)	-	-	33	40526	40526	\$ 9 ea
550 (Ser. # up to 236302121) (also 248674M91)	-	-	28	40526	40526	\$ 9 ea
540	-	-	-	40526	40526	\$ 9 ea
510 (Ser. # 1201009015 & up)	-	-	28	40526	40526	\$ 9 ea
410 (Ser. # 1200011754 & up)	-	-	28	40526	40526	\$ 9 ea

FOR WHITE

DESCRIPTION	PADDLE WITH CHAIN		NO OF PADDLES ON CHAIN	PADDLE ONLY FOR		RETAIL PRICE
	PART NO	RETAIL PRICE		MW CHAIN PART NO	OEM CHAIN PART NO	
9700 / 9720	81009	\$ 1123 kit	36	40530	40530	\$ 9 ea

All parts are 1/4" thick unless specified.

CHAIN REPLACEMENT PARTS			
PART NO	DESCRIPTION	RETAIL PRICE	PART NO DESCRIPTION RETAIL PRICE
81297	Connecting Link (CA550)	\$ 8 ea	23214 Connecting Link (CA550HD) \$ 15 ea
81298	1/2 Link (CA550)	\$ 8 ea	23215 Offset Link (CA550HD) \$ 9 ea
80986	Paddle Extension	\$ 20 ea	

- Please include serial number when ordering to help establish paddle size.
- Sprockets need to be changed to avoid premature chain wear.
- Re-tighten bolts after one day of use.
- Replace all rubber paddles with poly paddles to make your elevator fully efficient.

MINI COMBINE™ **NEW**

QUICK & ACCURATE CROP SAMPLING Save The Time and Expense of Getting Your Combine Out

- Self-contained unit comprised of a picker/threshing drum and an aerator/blower
- Comes with **4 interchangeable concaves** for various crops
- Lightweight, making sample collection easy
- **Accurate samples in minutes**, without the time and expense of running your combine
- **Achieve higher yields** while lowering your equipment and drying costs



Scan the code to see it in action!



MINI COMBINE™

PART NO	DESCRIPTION	RETAIL PRICE
83882	Mini Combine Harvester Kit Includes 4 concaves for various crops, lithium-ion battery, variable-speed brushless motor, 2 clear plastic collection jars, & carrying case	\$ 1565 ea

POLY CORN SNOOTS

PROVEN TO OUTPERFORM AND OUTLAST

Replace your existing metal or worn out poly corn gatherers with **GVL Poly Corn Snouts** and reap the benefits!



DESIGN INNOVATIONS:

- **Pivot Points**
 - Folds Up, In & Down
- **Easy Access for Cleaning & Maintenance**
- **Deeper Shoulders for Better Crop Retention**
- **Complete Poly Construction**
 - Inner & Outer Walls
- **Replace One Snout or Outfit the Whole Head**
- **Interchangeable**
- **Complete with Hardware for Easy Installation**

ADVANTAGES OF POLY MATERIAL COMPARED TO METAL:

- **More Economical & Weighs Less**
- **Absorbs Impact**
 - Less Bounce & Denting
- **Slick Surface Sheds Debris**
- **Less Ear Bounce & Butt Shelling**
- **Works Well in Down-Corn Situations**

ADDED FEATURES OF THE JACK-KNIFE DESIGN:

- **Folding Design Allows Snouts to be Popped Up & Latched in Seconds**
- **Easier Transport & Storage Positions**
- **Advanced Prop Rod System with Safety Lock Pin**

SERIES 1 - RIGID DESIGN

FOLDS UP FOR EASY ACCESS

Complete OEM Replacement with Rigid Design

Single pivot point allows snout to lift for easy access for maintenance.



SERIES 2 - JACK-KNIFE DESIGN

FOLDS UP, IN & DOWN

Complete OEM Replacement with Jack-Knife Design



Double pivot points allow the points to fold up, in and down for easy access for maintenance and uses less storage space.



Series I Back Poly has holes in the rear for the rear hold-down pin to go through.



Series II Back Poly is slanted, without holes in the rear.

POLY CORN SNOOTS



QUESTIONS? Watch our FAQ video.

SCAN ME



Scan the QR code with your smartphone to watch on YouTube.

Now you can order your snouts with all the parts included and pre-assembled!

Complete assembly includes:

Brackets, Front Poly, Wear Points and Hardware. Wear Strips are included on 30" snouts and larger.

FRONT POLY KITS FOR CASE IH 800 / 900 / 1000 SERIES				
PART NO	DESCRIPTION	LENGTH	SIZE	RETAIL PRICE
42652	Center Short - Front	47"	20"	\$ 290 ea
42648	Center Long - Front	59"	20"	\$ 290 ea
42666	Left End Short - Front	47"	20"	\$ 295 ea
42662	Left End Long - Front	59"	20"	\$ 290 ea
42674	Right End Short - Front	47"	20"	\$ 295 ea
42670	Right End Long - Front	59"	20"	\$ 295 ea
42660	Center Short - Front	47"	22"	\$ 290 ea
42656	Center Long - Front	59"	22"	\$ 290 ea
42678	Center - Front	-	30"	\$ 370 ea
42685	Right End - Front	-	30"	\$ 370 ea
42682	Left End - Front	-	30"	\$ 370 ea
42689	Center - Front	-	36"/38"	\$ 370 ea

FRONT POLY KITS FOR NEW HOLLAND 974 SERIES ONLY				
PART NO	DESCRIPTION	LENGTH	SIZE	RETAIL PRICE
42653	Center Short - Front	47"	20"	\$ 295 ea
42649	Center Long - Front	59"	20"	\$ 290 ea
42667	Left End Short - Front	47"	20"	\$ 295 ea
42663	Left End Long - Front	59"	20"	\$ 295 ea
42675	Right End Short - Front	47"	20"	\$ 295 ea
42671	Right End Long - Front	59"	20"	\$ 295 ea
42657	Center Long - Front	59"	22"	\$ 290 ea
42679	Center - Front	-	30"	\$ 370 ea
42722	Left End - Front	-	30"	\$ 370 ea
42686	Right End - Front	-	30"	\$ 370 ea
42690	Center - Front	-	36"/38"	\$ 370 ea

FRONT POLY KITS FOR JOHN DEERE 90 / 40 SERIES ONLY				
PART NO	DESCRIPTION	LENGTH	SIZE	RETAIL PRICE
42651	Center Short - Front	47"	20"	\$ 295 ea
42647	Center Long - Front	59"	20"	\$ 290 ea
42665	Left End Short - Front	47"	20"	\$ 295 ea
42661	Left End Long - Front	59"	20"	\$ 290 ea
42673	Right End Short - Front	47"	20"	\$ 295 ea
42669	Right End Long - Front	59"	20"	\$ 295 ea
42659	Center Short - Front	47"	22"	\$ 290 ea
42655	Center Long - Front	59"	22"	\$ 290 ea
42681	Left End - Front	-	30"/36"/38"	\$ 370 ea
42684	Right End - Front	-	30"/36"/38"	\$ 370 ea
42677	Center - Front	-	30"	\$ 370 ea

ATTENTION

GVL WILL ONLY INTERFACE WITH THE FOLLOWING OEM

- Case IH 3400 / 3200 / 2400 / 2200 • FRONT LEFT POLY • FRONT RIGHT POLY
- New Holland 98D / 98C / 96C / 996 • FRONT LEFT POLY • FRONT RIGHT POLY
- John Deere 600 / 700 / C-SERIES • CENTER FRONT POLY • CENTER BACK POLY



HIGHLIGHTED SNOOTS ARE IN STOCK AND READY TO SHIP

LEARN HOW TO ORDER GVL Poly Corn Snouts

Questions about GVL Poly Corn Snouts or what you need for your head?

Scan the QR code to learn more.





POLY CORN SNOOTS

INDIVIDUAL SNOOTS FOR CASE IH 3400 / 3200 / 2400 / 2200 SERIES. SERIES II - JACK KNIFE DESIGN. PART NO 43041, DESCRIPTION Center, ROW SIZE 30", RETAIL PRICE \$ 988 ea.

INDIVIDUAL SNOOTS FOR CASE IH 3400 / 3200 / 2400 / 2200 SERIES: FRONT POLY - LEFT OR RIGHT END ONLY. INTERFACES WITH OEM. PART NO 43060, Includes: Front Poly, Wear Point, Wear Strips & Hardware, ROW SIZE 30", RETAIL PRICE \$ 430 ea.

KITS FOR CASE IH 900 / 1000 SERIES. SERIES II - JACK KNIFE DESIGN. PART NO 84578-84583, DESCRIPTION 8 Row, 12 Row, 4 Row, 6 Row, 8 Row, 12 Row, ROW SIZE 22"-30", RETAIL PRICE \$ 6240-10450 ea.

SERIES I - RIGID DESIGN. PART NO 84568-84574, DESCRIPTION 4 Row, 6 Row, 8 Row, 4 Row, 6 Row, 8 Row, ROW SIZE 36"-38", RETAIL PRICE \$ 3830-6875 ea.

INDIVIDUAL SNOOTS FOR CASE IH 900 / 1000 SERIES. SERIES II - JACK KNIFE DESIGN. PART NO 42854-42857, DESCRIPTION Left End High - Short, Center - Short, Right End High - Short, Left End, Center, Right End, ROW SIZE 20"/30"/36"/38", RETAIL PRICE \$ 83-854 ea.

SERIES I - RIGID DESIGN. PART NO 42846-42847, DESCRIPTION Center, Center, ROW SIZE 36"/38", RETAIL PRICE \$ 757-780 ea.

KITS FOR CASE IH 800 SERIES. SERIES II - JACK KNIFE DESIGN. PART NO 84558-84563, DESCRIPTION 8 Row, 12 Row, 4 Row, 6 Row, 8 Row, 12 Row, ROW SIZE 22"-30", RETAIL PRICE \$ 6775-10750 ea.

SERIES I - RIGID DESIGN. PART NO 84544-84550, DESCRIPTION 4 Row, 6 Row, 8 Row, 4 Row, 6 Row, 8 Row, ROW SIZE 36"-38", RETAIL PRICE \$ 3860-6925 ea.

INDIVIDUAL SNOOTS FOR CASE IH 800 SERIES. SERIES II - JACK KNIFE DESIGN. PART NO 42838-42844, DESCRIPTION Left End High - Short, Center - Short, Right End High - Short, Left End High, Center, Right End High, ROW SIZE 20"/30"/36"/38", RETAIL PRICE \$ 822-883 ea.

SERIES I - RIGID DESIGN. PART NO 42830-42831, DESCRIPTION Center, Center, ROW SIZE 36"/38", RETAIL PRICE \$ 760 ea.

INDIVIDUAL SNOOTS FOR CASE IH 800 / 900 / 1000 SERIES - FRONT POLY ONLY. PART NO 42904-42950, DESCRIPTION Center - Long, Center - Short, Center - Long, Center - Short, Left End - Long, Left End - Short, Right End - Short, Right End - Long, Center, Center, Left End, Right End, ROW SIZE 20"/30"/36"/38", RETAIL PRICE \$ 210-220 ea.

INDIVIDUAL SNOOTS FOR CASE IH 800 / 900 / 1000 SERIES - BACK POLY ONLY. PART NO 42957-42985, DESCRIPTION Center - Series I, Center - Series I, Center - Series II, Left End - Short, Right End - Short, Center - Series I, Center - Series II, Center, Left End Short, Right End Short, End High Extension w/hardware, End Low Extension w/hardware, End High Extension w/hardware, ROW SIZE 20"/30"/36"/38", RETAIL PRICE \$ 150-222 ea.

IN STOCK Ready to Ship HIGHLIGHTED SNOOTS ARE IN STOCK AND READY TO SHIP

ATTENTION GVL WILL ONLY INTERFACE WITH THE FOLLOWING OEM Case IH 3400 / 3200 / 2400 / 2200 • FRONT LEFT POLY • FRONT RIGHT POLY New Holland 98D / 98C / 96C / 996 • FRONT LEFT POLY • FRONT RIGHT POLY John Deere 600 / 700 / C-SERIES • CENTER FRONT POLY • CENTER BACK POLY



POLY CORN SNOOTS

INDIVIDUAL SNOOTS FOR NEW HOLLAND 98D / 98C / 96C / 996 SERIES. SERIES II - JACK KNIFE DESIGN. PART NO 43044, DESCRIPTION Center, ROW SIZE 30", RETAIL PRICE \$ 988 ea.

INDIVIDUAL SNOOTS FOR NEW HOLLAND 98D / 98C / 96C / 996 SERIES: FRONT POLY - LEFT OR RIGHT END ONLY. INTERFACES WITH OEM. PART NO 43062, Includes: Front Poly, Wear Point, Wear Strips & Hardware, ROW SIZE 30", RETAIL PRICE \$ 425 ea.

INDIVIDUAL CENTER SNOOTS AND POLY FOR JOHN DEERE 600 / 700 / C-SERIES. INTERFACES WITH OEM - REUSE OEM BRACKETS & HARDWARE. PART NO 42800-42898, DESCRIPTION Center Row Assembly, Front Poly Assembly, Back Poly Assembly, ROW SIZE 30", RETAIL PRICE \$ 620-285 ea.

KITS FOR JOHN DEERE 40 SERIES. SERIES II - JACK KNIFE DESIGN. PART NO 84610-84519, DESCRIPTION 8 Row, 12 Row, 8 Row, 12 Row, 4 Row, 6 Row, 8 Row, 12 Row, ROW SIZE 20"/22"/30", RETAIL PRICE \$ 6270-10120 ea.

INDIVIDUAL SNOOTS FOR JOHN DEERE 40 SERIES. SERIES II - JACK KNIFE DESIGN. PART NO 42810-42814, DESCRIPTION Left End - Short, Center - Short, Center - Short, Right End - Short, Left End, Center, Right End, ROW SIZE 20"/30"/36"/38", RETAIL PRICE \$ 769-780 ea.



IN STOCK Ready to Ship HIGHLIGHTED SNOOTS ARE IN STOCK AND READY TO SHIP

ATTENTION GVL WILL ONLY INTERFACE WITH THE FOLLOWING OEM Case IH 3400 / 3200 / 2400 / 2200 • FRONT LEFT POLY • FRONT RIGHT POLY New Holland 98D / 98C / 96C / 996 • FRONT LEFT POLY • FRONT RIGHT POLY John Deere 600 / 700 / C-SERIES • CENTER FRONT POLY • CENTER BACK POLY

KITS FOR JOHN DEERE 90 SERIES. SERIES II - JACK KNIFE DESIGN. PART NO 84606-84539, DESCRIPTION 8 Row, 12 Row, 8 Row, 12 Row, 4 Row, 6 Row, 8 Row, 12 Row, ROW SIZE 20"/30", RETAIL PRICE \$ 6215-10560 ea.

INDIVIDUAL SNOOTS FOR JOHN DEERE 90 SERIES. SERIES II - JACK KNIFE DESIGN. PART NO 42810-42814, DESCRIPTION Left End - Short, Center - Short, Center - Short, Right End - Short, Left End, Center, Right End, ROW SIZE 20"/30"/36"/38", RETAIL PRICE \$ 769-820 ea.

INDIVIDUAL SNOOTS FOR JOHN DEERE 40 & 90 SERIES - FRONT POLY ONLY. PART NO 42901-42949, DESCRIPTION End, Center, Center - Long, Center - Short, Center - Long, Center - Short, Left End - Long, Left End - Short, Right End - Long, Right End - Short, Center, Center, Left End, Right End, ROW SIZE 15"/20"/22"/30"/36"/38", RETAIL PRICE \$ 125-220 ea.

INDIVIDUAL SNOOTS FOR JOHN DEERE 40 & 90 SERIES - BACK POLY ONLY. PART NO 42955-42991, DESCRIPTION End, Center, Center - Series I, Center - Series II, Center - Series I, Center - Series II, Left End - Long, Right End - Long, Center - Series I, Center - Series II, Center, Left End Long, Right End Long, ROW SIZE 15"/20"/22"/30"/36"/38", RETAIL PRICE \$ 170-310 ea.

CORN HEAD PARTS



POLY CORN SNOOTS

INDIVIDUAL SNOOTS FOR AGCO SNOOTS - FRONT POLY ONLY

PART NO	DESCRIPTION	LENGTH	ROW SIZE	RETAIL PRICE
42906	Center - Long	59"	20"	\$ 210 ea
42909	Center - Short	47"	20"	\$ 210 ea
42914	Center - Long	59"	22"	\$ 210 ea
42918	Center - Short	47"	22"	\$ 210 ea
42923	Left End - Long	59"	20"/22"	\$ 210 ea
42926	Left End - Short	47"	20"/22"	\$ 210 ea
42930	Right End - Long	59"	20"/22"	\$ 210 ea
42933	Right End - Short	47"	20"/22"	\$ 210 ea
42938	Center	-	30"	\$ 215 ea
42947	Left End	-	30"/36"/38"	\$ 220 ea
42952	Right End	-	30"/36"/38"	\$ 220 ea

INDIVIDUAL SNOOTS FOR AGCO SNOOTS - BACK POLY ONLY

PART NO	DESCRIPTION	ROW SIZE	RETAIL PRICE
42959	Center - Series I	20"	\$ 150 ea
42966	Center - Series I	22"	\$ 150 ea
42588	Left End - Series I	20"/22"	\$ 250 ea
42589	Right End - Series I	20"/22"	\$ 250 ea
42980	Center - Series I	30"	\$ 200 ea
42987	Center - Series I	36"/38"	\$ 200 ea
42586	Left End - Series I	30"/36"/38"	\$ 270 ea
42587	Right End - Series I	30"/36"/38"	\$ 270 ea

ATTENTION

GVL WILL ONLY INTERFACE WITH THE FOLLOWING OEM

- Case IH 3400 / 3200 / 2400 / 2200 - FRONT LEFT POLY
- FRONT RIGHT POLY
- New Holland 98D / 98C / 96C / 996 - FRONT LEFT POLY
- FRONT RIGHT POLY
- John Deere 600 / 700 / C-SERIES - CENTER FRONT POLY
- CENTER BACK POLY

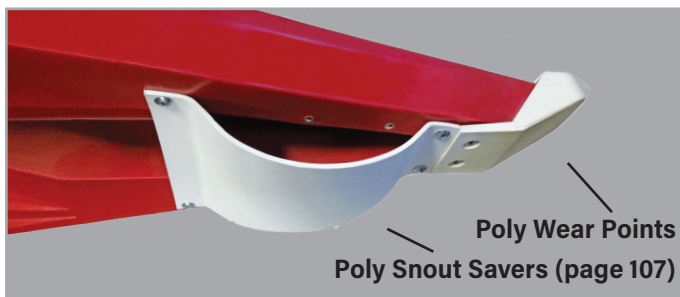

POLY CORN SNOOT REPLACEMENT PARTS FOR GVL

EAR SAVERS FOR GVL SNOOTS

PART NO	DESCRIPTION	RETAIL PRICE
42880	Ear Saver for GVL Poly Snouts	\$ 17 ea

STAINLESS STEEL WEAR STRIPS

PART NO	DESCRIPTION	RETAIL PRICE
42868	Left Edge for Center Snouts (All Sizes)	\$ 55 ea
42869	Right Edge for Center Snouts (All Sizes)	\$ 55 ea
42869	Left Hand End Snout (20" Only)	\$ 55 ea
42868	Right Hand End Snout (20" Only)	\$ 55 ea
42871	Left Hand End Snout (30" Only)	\$ 58 ea
42870	Right Hand End Snout (30" Only)	\$ 58 ea

FOR Case IH 3400/3200/2600/2400/2200 & New Holland 99C/98C/98D/96C/996

43052	Left Edge for Center Snouts (30" Only)	\$ 50 ea
43053	Right Edge for Center Snouts (30" Only)	\$ 50 ea
43064	FOR Case IH 2200 - End Front Wear Strip Kit Includes Left Edge, Right Edge & Hardware	\$ 115 ea

STAINLESS STEEL WEAR STRIPS (CONTINUED)

PART NO	DESCRIPTION	RETAIL PRICE
FOR John Deere 600/700/C-Series		
42717	Left Edge for Center Snouts (30" Only)	\$ 75 ea
42718	Right Edge for Center Snouts (30" Only)	\$ 75 ea

INDIVIDUAL POLY WEAR POINTS

PART NO	DESCRIPTION	RETAIL PRICE
42867	Wear Point - White	\$ 30 ea
42716	Wear Point - Yellow	\$ 35 ea

SNOOT SAVERS

PART NO	DESCRIPTION	RETAIL PRICE
82607	Narrow Snout Saver - 20"/22" Centers, 20"/30" Ends	\$ 27 ea
82606	Wide Snout Saver - 30"/36"/38" Centers	\$ 27 ea

MISCELLANEOUS PARTS

PART NO	DESCRIPTION	RETAIL PRICE
42699	30" Center Gas Strut Kit (Series II)	\$ 157 ea



CORN HEAD AUGER TROUGH LINERS

Protect the high-wear areas in your auger trough - **Page 108**



CROP DIVIDER FRONT WEAR KITS FOR OEM POLY

THE SLEEK AND HIGHLY DURABLE PLASTIC REPLACEMENT WEAR STRIP EXTENDS THE LIFE OF POLY CORN HEADS

PREVENT PREMATURE WEAR OR REPAIR DAMAGED SNOOTS

PART NO	DESCRIPTION	RETAIL PRICE
83755	FOR John Deere 600 and 90 - Series 1 Serial #695300 & Before	\$ 30.59 ea
83756	FOR John Deere 600 and 90 - Series 2 Serial #695301 & After	\$ 30.59 ea

Kit includes 1 left strip, 1 right strip & hardware (nuts & bolts).

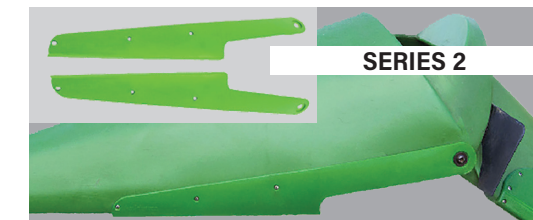
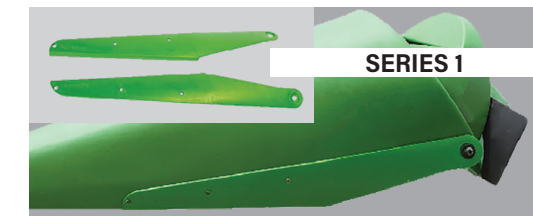

CROP DIVIDER REAR WEAR KITS FOR OEM POLY

PREVENT PREMATURE WEAR OR REPAIR DAMAGED SNOOTS

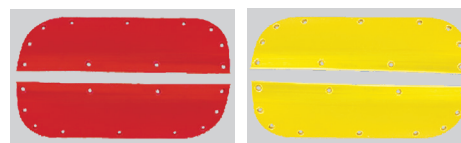
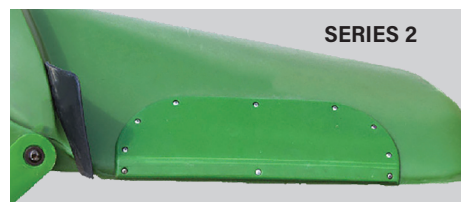

Wear strips are molded for an exact-fit design with high-friction tested material to last a very long time in the field.

The smooth finish ensures a quality flow, even when combining.

PART NO	DESCRIPTION	DIMENSIONS	RETAIL PRICE
83759	FOR Case IH 2200 / 2400 / 2600 / 3200 / 3400 - Small	4 1/2" x 16"	\$ 21.59 kit
83886	FOR Case IH 2200 / 2400 / 2600 / 3200 / 3400 - Large	6 1/2" x 18"	\$ 27.75 kit
83760	FOR New Holland 96C / 98C / 98D / 99C / 996 - Small	4 1/2" x 16"	\$ 21.59 kit
83887	FOR New Holland 96C / 98C / 98D / 99C / 996 - Large	6 1/2" x 18"	\$ 27.75 kit
83757	FOR John Deere 600 / 90 - Series 1 Serial #695300 & Before	4 1/2" x 16"	\$ 21.59 kit
83758	FOR John Deere 600 / 90 - Series 2 Serial #695301 & After	4 1/2" x 18 1/2"	\$ 21.59 kit

Kit includes 1 left strip, 1 right strip and hardware (sheet metal screw).

UNIVERSAL POLY SNOOT PATCH - 1/8" THICK

REPAIR HIGH WEAR AREAS ON POLY CORN HEADS, NEAR THE GATHERING CHAINS AND SNAPPING ROLLERS.

UHMW poly material is stronger and more wear-resistant than the original poly head material.

PART NO	DESCRIPTION	DIMENSIONS	RETAIL PRICE
40998	White	9" x 23"	\$ 24 kit
41497	Red	9" x 23"	\$ 24 kit
41498	Green	9" x 23"	\$ 24 kit

Kit includes 1 poly patch with hardware (self tapping screws).





POLY SNOOT SAVERS

FOR CASE IH

PART NO	DESCRIPTION	FRONT WIDTH	BACK WIDTH	RETAIL PRICE
83928	2600 /4200 /4400 - Inside - 30"	4"	9"	\$ 27 ea
83929	2600 /4200 /4400 - Outside - 30"	4"	7"	\$ 27 ea
83922	2600 /4200 /4400 - Inside - 20/22"	4"	6 1/4"	\$ 27 ea
83924	2600 /4200 /4400 - Outside - 20/22"	4 1/4"	6 1/2"	\$ 27 ea
83795	2200 /2400 /3200 /3400 - Inside	3"	5 1/4"	\$ 27 ea
83796	2200 /2400 /3200 /3400 - Inside with cutout for Height Control Sensor	3"	5 1/4"	\$ 27 ea
83797	2200 /2400 /3200 /3400 - Outside	3"	5 1/4"	\$ 27 ea
83798	2200 /2400 /3200 /3400 - Outside with cutout for Height Control Sensor	3"	5 1/4"	\$ 27 ea
80837	Inside Snout - Metal Head Only	1 1/8"	5 3/4"	\$ 27 ea
80838	Outside Snout - Metal Head Only	1"	3 7/8"	\$ 27 ea

PREVENT DAMAGE TO COMBINE SNOOTS

The curved design for hollow points is used to lift the point off the ground and create a larger surface area for ground contact. This feature keeps the snout from digging into the dirt and wrinkling the snout, which results in costly repair or replacement.



Inside & Outside Snouts for Case IH 2200/2400/3200/3400

Inside & Outside Snouts with cutout for Height Control Sensor for Case IH 2200/2400/3200/3400



FOR JOHN DEERE

PART NO	DESCRIPTION	FRONT WIDTH	BACK WIDTH	RETAIL PRICE
83624	600 /700 /C-Series - Inside - 30"	3"	7 7/8"	\$ 27 ea
83625	600 /700 - Outside - 30"	3"	6 1/8"	\$ 27 ea
84030	600 /700 /C-Series - Inside - 20/22"	3"	6 1/2"	\$ 27 ea
84032	600 /700 - Outside - 20/22"	4 1/2"	9"	\$ 27 ea
80839	90 /40 Inside Snout - Metal Head Only	2"	6 5/8"	\$ 27 ea
80840	90 /40 Outside Snout - Metal Head	2"	5 1/4"	\$ 27 ea

FOR DRAGO

PART NO	DESCRIPTION	FRONT WIDTH	BACK WIDTH	RETAIL PRICE
82606	Inside Snout	3 1/2"	8"	\$ 27 ea
82607	Outside Snout	3 1/4"	6 1/4"	\$ 27 ea

FOR POLY HEADS

PART NO	DESCRIPTION	FRONT WIDTH	BACK WIDTH	RETAIL PRICE
82606	Inside Snout	3 1/2"	8"	\$ 27 ea
82607	Outside Snout	3 1/4"	6 1/4"	\$ 27 ea

SNOOT BOOTS

FOR CASE IH / NEW HOLLAND (Gray) - Fits Case IH 2200 /2400 /2600 /3200 /3400 Series & New Holland 98C /98D /99C Series

PART NO	DESCRIPTION	RETAIL PRICE
83753	FOR Case IH / New Holland (Gray) - Fits Case IH 2200 /2400 /2600 /3200 /3400 Series & New Holland 98C /98D /99C Series	\$ 13.25 ea

FOR JOHN DEERE (Yellow) - Fits over existing cast point on all 600, 700, 90 & C Series

PART NO	DESCRIPTION	RETAIL PRICE
83752	FOR John Deere (Yellow) - Fits over existing cast point on all 600, 700, 90 & C Series	\$ 17.55 ea

Hardware included (bolt).

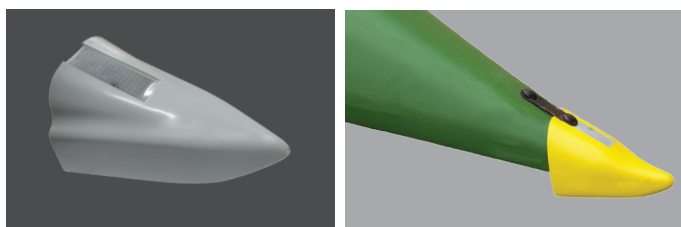

THE HIGH IMPACT MATERIAL ENSURES A DURABLE PRODUCT THAT WILL BE ON YOUR CORN HEAD FOR YEARS TO COME.

Designed with a smooth surface to aid in preventing trash build up, Snoot Boots easily slide and snap over your existing points. The high visibility boots aid in finding your row centers in rainy harvesting conditions.

SCAN ME

INSTALLATION VIDEO
John Deere C-Series

Featuring
Minnesota Millennial Farmer



Check out our website - WWW.MAYWES.COM for more information, installation instructions and our full lineup of poly products.



AUGER TROUGH LINERS FOR CORN HEADS - 1/8" THICK

DURABLE POLY WON'T RUST.

May Wes Auger Trough Liners

cover the full length of the floor under the auger – not just the feed opening.

Condensation and wet corn will not corrode poly lining when the metal is covered with poly. Even when metal lining is corroded, the poly lining keeps loose grain from falling through rust holes and feeds grain evenly into the throat of the combine.

Poly lining is much easier to replace than factory metal.

Simply drill and rivet into place.



FOR CASE IH

DESCRIPTION	LINER DEPTH (FRONT TO BACK)	ROW SIZE	PART NO GREEN	PART NO WHITE	PART NO RED	RETAIL PRICE
2600 /4200 /4400 Series - 6 Row	17 3/4"	30" Row	-	83854	83861	\$ 366 kit
2600 /4200 /4400 Series - 8 Row	17 3/4"	30" Row	-	83855	83862	\$ 500 kit
2600 /4200 /4400 Series - 12 Row	17 3/4"	30" Row	-	83856	83863	\$ 732 kit
2600 /4200 /4400 Series - 16 Row	17 3/4"	30" Row	-	83857	83864	\$ 958 kit
2200 /2400 /3200 /3400 Series - 4 Row	23 1/4"	30" Row	-	82647	82825	\$ 320 kit
2200 /2400 /3200 /3400 Series - 6 Row	23 1/4"	30" Row	-	82648	82826	\$ 366 kit
2200 /2400 /3200 /3400 Series - 8 Row	23 1/4"	30" Row	-	82649	82827	\$ 500 kit
2200 /2400 /3200 /3400 Series - 12 Row	23 1/4"	30" Row	-	82650	82828	\$ 732 kit
2200 /2400 /3200 /3400 Series - 16 Row	23 1/4"	30" Row	-	83850	83851	\$ 958 kit
900 /1000 Series - 4 Row	15 1/2"	30" Row	-	82643	82821	\$ 320 kit
900 /1000 Series - 6 Row	15 1/2"	30" Row	-	82644	82822	\$ 366 kit
900 /1000 Series - 8 Row	15 1/2"	30" Row	-	82645	82823	\$ 500 kit
900 /1000 Series - 12 Row	15 1/2"	30" Row	-	82646	82824	\$ 732 kit

FOR NEW HOLLAND

DESCRIPTION	LINER DEPTH (FRONT TO BACK)	ROW SIZE	PART NO GREEN	PART NO WHITE	PART NO RED	RETAIL PRICE
New Holland 96C /98C /98D - 4 Row	23 1/4"	30" Row	-	82647	-	\$ 320 kit
New Holland 96C /98C /98D - 6 Row	23 1/4"	30" Row	-	82648	-	\$ 366 kit
New Holland 96C /98C /98D - 8 Row	23 1/4"	30" Row	-	82649	-	\$ 500 kit
New Holland 96C /98C /98D - 12 Row	23 1/4"	30" Row	-	82650	-	\$ 732 kit

FOR JOHN DEERE

DESCRIPTION	LINER DEPTH (FRONT TO BACK)	ROW SIZE	PART NO GREEN	PART NO WHITE	PART NO RED	RETAIL PRICE
600 /700 /C Series - 6 Row	20"	30" Row	82880	82727	-	\$ 366 kit
600 /700 /C Series - 8 Row	20"	30" Row	82881	82728	-	\$ 500 kit
600 /700 /C Series - 12 Row	20"	30" Row	82882	82729	-	\$ 732 kit
40 /90 Series - 4 Row	15 1/2"	30" Row	82793	82075	-	\$ 320 kit
40 /90 Series - 6 Row	15 1/2"	30" Row	82794	82076	-	\$ 366 kit
40 /90 Series - 8 Row	15 1/2"	30" Row	82795	82077	-	\$ 505 kit
40 /90 Series - 12 Row	15 1/2"	30" Row	82796	82078	-	\$ 737 kit

UNIVERSAL AUGER LINER KITS NEW

DESCRIPTION	LINER DEPTH (FRONT TO BACK)	ROW SIZE	PART NO GREEN	PART NO WHITE	PART NO RED	RETAIL PRICE
6 Row Universal Kit	24"	30" Row	-	85030	-	\$ 366 kit
8 Row Universal Kit	24"	30" Row	-	85031	-	\$ 500 kit
12 Row Universal Kit	24"	30" Row	-	85032	-	\$ 732 kit

Just need a single replacement panel? Order online or call May Wes at 1-800-788-6483.

KERNEL KEEPER™

EXPANDED LINEUP

CUSHION AND CAPTURE TO REDUCE KERNEL SHATTER AND PUT MORE KERNELS IN YOUR COMBINE.

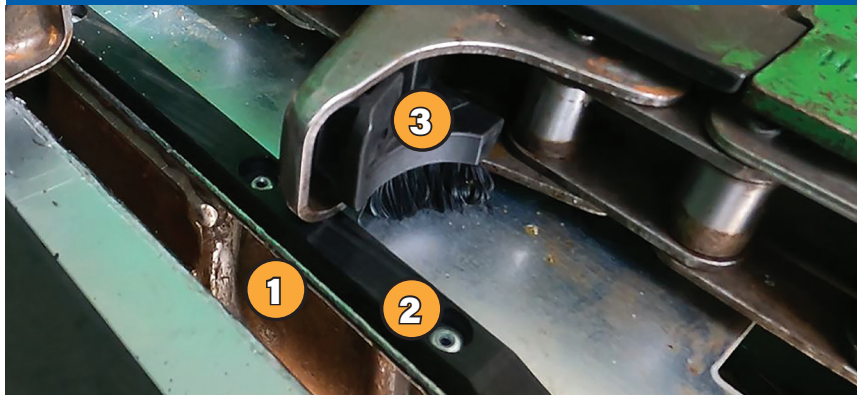

HOW DOES IT WORK?

1. Dampener rails cushion the impact of the ear on the deck plate, absorbing the energy and resulting in fewer kernels dislodging from the ear.
2. Rails also capture any dislodged kernels before they can slide between the deck plates.
3. Brushes sweep the captured kernels into the auger bed and into the combine.

CALCULATE YOUR SAVINGS

Head Size	6	8	12	16	
Cost of Product	\$1170	\$1560	\$2340	\$3120	
Life of Product (Acres)	900	1,200	1,800	2,400	
NET RETURNS Over Life of Product					
Savings per Acre	Bushel Price	Estimated Returns			
	\$4.00	\$4,230	\$5,640	\$8,460	\$11,280
Bushels: 1.5	\$5.00	\$5,580	\$7,440	\$11,160	\$14,880
	\$6.00	\$6,930	\$9,240	\$13,860	\$18,480
	\$7.00	\$8,280	\$11,040	\$16,560	\$22,080



SAVE OVER \$500 PER ROW VS THE COMPETITION

At \$195 per row, we offer the most cost effective solution to head loss on the market. **The Kernel Keeper is profitable at just 1/3 bushel savings per acre, while average head loss is 2-3 bushels per acre.**

Lower band of savings based on average loss and % kernels saved in field testing.

KITS FOR CASE IH				REPLACEMENT PARTS				
MODEL	THREADED KIT	RIVETED KIT	RETAIL PRICE	THREADED RAILS	RIVETED RAILS	RETAIL PRICE	BRUSHES	RETAIL PRICE
4400 /4200 /2600	84054	84055	\$ 390 kit	43230	43231	\$ 143 row	43237	\$ 157 row
3400 /3200 /2400 /2200	84056	84057	\$ 390 kit	43230	43231	\$ 143 row	43238	\$ 157 row
1000 /900 /800	84058	84059	\$ 390 kit	43224	43225	\$ 143 row	43236	\$ 157 row

One kit covers two rows. Includes 4 rails, 32 brushes, and hardware.

All replacement parts include hardware for easy installation.

PRE-DRILLED DECK PLATES FOR CASE IH					
MODEL	OEM	LH/RH	DESCRIPTION	PART NO	RETAIL PRICE
4400 /4200 /2600 Series Chopping Heads	48007792	LH	Beveled	43251	\$ 124.50 ea
	48007795	RH	Hydraulic Beveled	43252	\$ 124.50 ea
4400 /4200 /2600 Series Non-Chopping Heads	47474090	LH	Beveled	43253	\$ 124.50 ea
	84972758	RH	Hydraulic Beveled	43254	\$ 124.50 ea
3400 /3200 Series	84410193	LH	Hydraulic Beveled	43255	\$ 124.50 ea
	84410217	RH	Beveled	43256	\$ 124.50 ea
2400 /2200 Series	87047608	LH	Hydraulic Beveled	43257	\$ 124.50 ea
	87047540	LH	Beveled	43258	\$ 124.50 ea
	286978032	RH	Beveled	43259	\$ 124.50 ea
1000 /900 Series	199381C1	LH	Beveled	43260	\$ 94.00 ea
	199382C1	RH	Beveled	43261	\$ 94.00 ea
800 Series	176292C91	LH	Beveled	43262	\$ 94.00 ea
	176291C91	RH	Beveled	43263	\$ 94.00 ea

KERNEL KEEPER™

EXPANDED LINEUP

KITS FOR JOHN DEERE				REPLACEMENT PARTS				
MODEL	THREADED KIT	RIVETED KIT	RETAIL PRICE	THREADED RAILS	RIVETED RAILS	RETAIL PRICE	BRUSHES	RETAIL PRICE
700 /C-Series /Rowmax	84046	84047	\$ 390 kit	43224	43225	\$ 143 row	43234	\$ 157 row
600 Series	84048	84049	\$ 390 kit	43224	43225	\$ 143 row	43235	\$ 157 row
90/40 Series	84050	84051	\$ 390 kit	43224	43225	\$ 143 row	43236	\$ 157 row

One kit covers two rows. Includes 4 rails, 32 brushes, and hardware.

All replacement parts include hardware for easy installation.

PRE-DRILLED DECK PLATES FOR JOHN DEERE					
MODEL	OEM	LH/RH	DESCRIPTION	PART NO	RETAIL PRICE
700 /C-Series /Rowmax / 600 Series After Serial #745101	AH234656	LH	Hydraulic Flat	43242	\$ 124.50 ea
	AH237437	RH	Flat	43241	\$ 124.50 ea
600 Series Before Serial #745101	AH232250	LH	Hydraulic Flat	43244	\$ 124.50 ea
	H225719	RH	Flat	43243	\$ 124.50 ea
90 Series	AH147773	LH	Hydraulic Flat	43246	\$ 124.50 ea
	H154270	RH	Flat	43245	\$ 124.50 ea
40 Series	N102069	LH	Flat - High Tin	43247	\$ 94.00 ea
	N102068	RH	Flat - High Tin	43248	\$ 94.00 ea
	H94952	LH	Flat - Low Tin	43249	\$ 94.00 ea
	H94952	RH	Flat - Low Tin	43250	\$ 94.00 ea

KITS FOR DRAGO				REPLACEMENT PARTS				
MODEL	THREADED KIT	RIVETED KIT	RETAIL PRICE	THREADED RAILS	RIVETED RAILS	RETAIL PRICE	BRUSHES	RETAIL PRICE
GT /Series II /Series I	84046	84047	\$ 390 kit	43224	43225	\$ 143 row	43234	\$ 157 row

One kit covers two rows. Includes 4 rails, 32 brushes, and hardware.

All replacement parts include hardware for easy installation.

KITS FOR GERINGHOFF				REPLACEMENT PARTS				
MODEL	THREADED KIT	RIVETED KIT	RETAIL PRICE	THREADED RAILS	RIVETED RAILS	RETAIL PRICE	BRUSHES	RETAIL PRICE
Northstar /Rota Disc	84052	84053	\$ 390 kit	43224	43225	\$ 143 row	43237	\$ 157 row

One kit covers two rows. Includes 4 rails, 32 brushes, and hardware.

All replacement parts include hardware for easy installation.



SIGNIFICANT SAVINGS

Pays for itself after just 1/3 bushel per acre savings.



EASY INSTALLATION

Compatible with OEM deck plates and chains. Pre-drilled deck plates also available.



MADE IN THE U.S.A.

Durable UHMW poly rails are non-stick and impact resistant.



QUESTIONS?

Watch our Kernel Keeper FAQ video.



INSTALL VIDEO

Learn how to install the Kernel Keeper.



FEATURED BY

Minnesota Millennial Farmer

SHOE COVER FOR JOHN DEERE C-SERIES OEM STALK STOMPERS



CNC machine cut and predrilled. Includes single shoe cover and hardware (nuts and bolts).

42756 \$ 42 ea



CROP SHIELDS / TRASH APRONS

• 1/4" THICK CLOTH EMBEDDED RUBBER • LESS EXPENSIVE THAN OEM • HARDWARE INCLUDED

KIT FOR JOHN DEERE 606C
30" Row Spacing - Before Serial Number 745100

PART NO	MODEL	ROW SPACING	SERIAL NUMBER BREAK	RETAIL PRICE
84948	606C	30"	Before 745100	\$ 526 kit

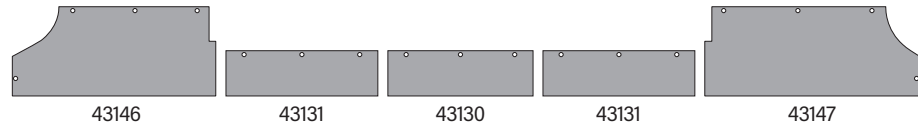

REPLACEMENT PARTS

PART NO	OEM	WIDTH	RETAIL PRICE	PART NO	OEM	WIDTH	RETAIL PRICE
43130	H227177	28 7/8"	\$ 63 ea	43146	H228482	40 1/2"	\$ 168 ea
43131	H227178	30 7/8"	\$ 62 ea	43147	H228483	40 3/4"	\$ 168 ea

KIT FOR JOHN DEERE C6R/606C/706C
30" Row Spacing - After Serial Number 745101

PART NO	MODEL	ROW SPACING	SERIAL NUMBER BREAK	RETAIL PRICE
84949	C6R/606C/706C	30"	After 745101	\$ 371 kit

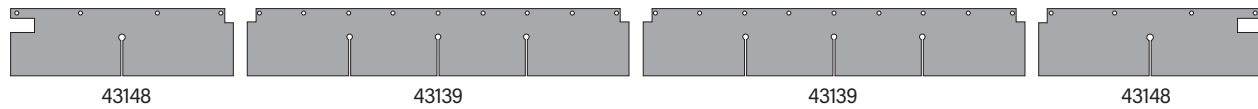

REPLACEMENT PARTS

PART NO	OEM	WIDTH	RETAIL PRICE	PART NO	OEM	WIDTH	RETAIL PRICE
43139	HXE30386	54"	\$ 92 ea	43148	HXE89078	31 1/2"	\$ 92 ea

KIT FOR JOHN DEERE 608C
30" Row Spacing - Before Serial Number 745100

PART NO	MODEL	ROW SPACING	SERIAL NUMBER BREAK	RETAIL PRICE
84950	608C	30"	Before 745100	\$ 557 kit

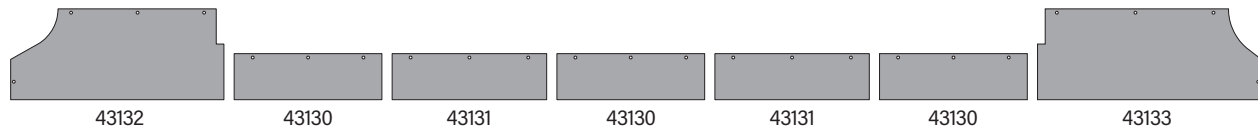

REPLACEMENT PARTS

PART NO	OEM	WIDTH	RETAIL PRICE	PART NO	OEM	WIDTH	RETAIL PRICE
43130	H227177	28 7/8"	\$ 63 ea	43132	H227180	41 11/16"	\$ 116 ea
43131	H227178	30 7/8"	\$ 62 ea	43133	H227181	43 3/4"	\$ 134 ea

KIT FOR JOHN DEERE C8R/608C/708C
30" Row Spacing - After Serial Number 745101

PART NO	MODEL	ROW SPACING	SERIAL NUMBER BREAK	RETAIL PRICE
84951	C8R/608C/708C	30"	After 745100	\$ 536 kit

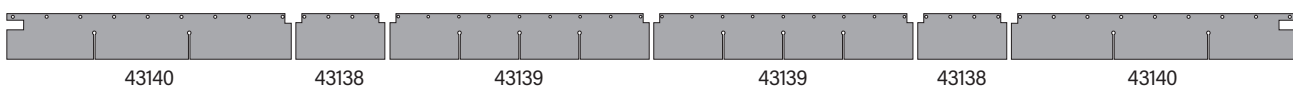

REPLACEMENT PARTS

PART NO	OEM	WIDTH	RETAIL PRICE	PART NO	OEM	WIDTH	RETAIL PRICE
43138	HXE21077	18 9/16"	\$ 66 ea	43139	HXE30386	54"	\$ 92 ea
				43140	HXE89079	42 3/4"	\$ 102 ea



CROP SHIELDS / TRASH APRONS

KIT FOR JOHN DEERE 612C
20" Row Spacing - Before Serial Number 745100

PART NO	MODEL	ROW SPACING	SERIAL NUMBER BREAK	RETAIL PRICE
84953	612C	20"	Before 745100	\$ 701 kit

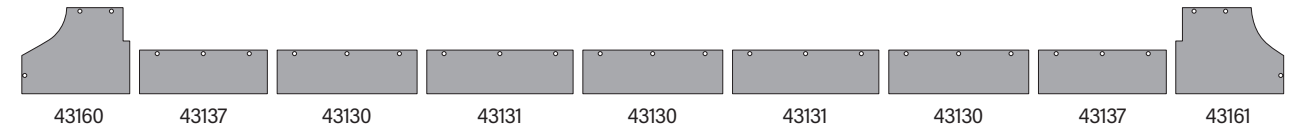

REPLACEMENT PARTS

PART NO	OEM	WIDTH	RETAIL PRICE	PART NO	OEM	WIDTH	RETAIL PRICE
43130	H227177	28 7/8"	\$ 63 ea	43160	H233429	22 1/4"	\$ 109 ea
43131	H227178	30 7/8"	\$ 62 ea	43161	H228508	22 1/4"	\$ 128 ea
43137	H227185	26 3/8"	\$ 82 ea				

KIT FOR JOHN DEERE C12R/612C/712C
20" Row Spacing - After Serial Number 745101

PART NO	MODEL	ROW SPACING	SERIAL NUMBER BREAK	RETAIL PRICE
84954	C12R/612C/712C	20"	After 745101	\$ 577 kit

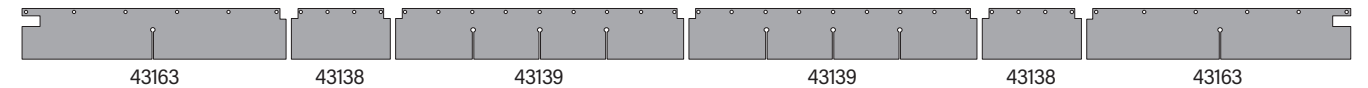

REPLACEMENT PARTS

PART NO	OEM	WIDTH	RETAIL PRICE	PART NO	OEM	WIDTH	RETAIL PRICE
43138	HXE21077	18 9/16"	\$ 66 ea	43139	HXE30386	54"	\$ 92 ea
				43163	HXE89083	49 1/2"	\$ 121 ea

KIT FOR JOHN DEERE 612C
22" Row Spacing - Before Serial Number 745100

PART NO	MODEL	ROW SPACING	SERIAL NUMBER BREAK	RETAIL PRICE
84955	612C	22"	Before 745100	\$ 691 kit

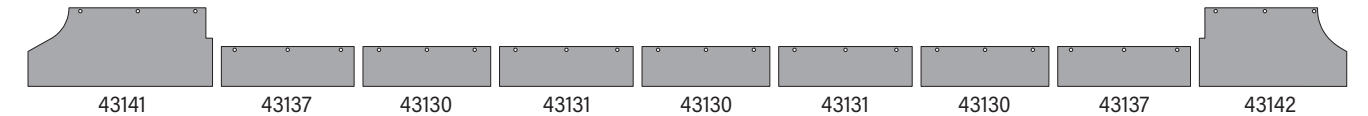

REPLACEMENT PARTS

PART NO	OEM	WIDTH	RETAIL PRICE	PART NO	OEM	WIDTH	RETAIL PRICE
43130	H227177	28 7/8"	\$ 63 ea	43141	H228513	41 11/16"	\$ 116 ea
43131	H227178	30 7/8"	\$ 62 ea	43142	H228514	33 5/16"	\$ 116 ea
43137	H227185	26 3/8"	\$ 82 ea				

KIT FOR JOHN DEERE 612C
22" Row Spacing - Serial Number 745101 - 774999

PART NO	MODEL	ROW SPACING	SERIAL NUMBER BREAK	RETAIL PRICE
84496	612C	22"	745101 - 774999	\$ 541 kit

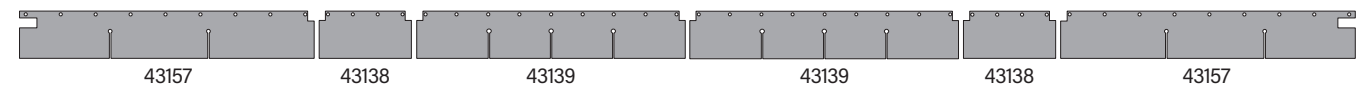

REPLACEMENT PARTS

PART NO	OEM	WIDTH	RETAIL PRICE	PART NO	OEM	WIDTH	RETAIL PRICE
43138	HXE21077	18 9/16"	\$ 66 ea	43139	HXE30386	54"	\$ 92 ea
				43157	HXE89085	59 1/4"	\$ 116 ea



CROP SHIELDS / TRASH APRONS

KIT FOR JOHN DEERE C12R/612C/712C
22" Row Spacing - After Serial Number 774999

PART NO	MODEL	ROW SPACING	SERIAL NUMBER BREAK	RETAIL PRICE
84956	C12R/612C/712C	22"	After 774999	\$ 505 kit

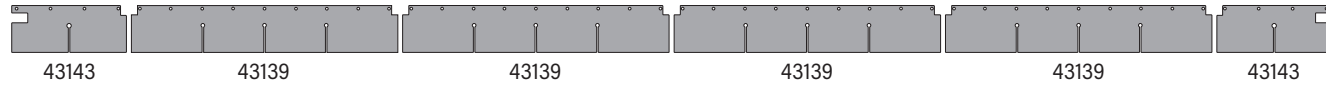

REPLACEMENT PARTS

PART NO	OEM	WIDTH	RETAIL PRICE	PART NO	OEM	WIDTH	RETAIL PRICE
43139	HXE30386	54"	\$ 92 ea	43143	HXE89077	23 1/4"	\$ 64 ea

KIT FOR JOHN DEERE 612C
30" Row Spacing - Before Serial Number 745100

PART NO	MODEL	ROW SPACING	SERIAL NUMBER BREAK	RETAIL PRICE
84957	612C	30"	Before 745100	\$ 979 kit



REPLACEMENT PARTS

PART NO	OEM	WIDTH	RETAIL PRICE	PART NO	OEM	WIDTH	RETAIL PRICE
43130	H227177	28 7/8"	\$ 63 ea	43137	H227185	26 3/8"	\$ 82 ea
43131	H227178	30 7/8"	\$ 62 ea	43144	H227183	43 3/4"	\$ 168 ea
43136	H227184	33 5/16"	\$ 82 ea	43145	H227182	41 3/4"	\$ 168 ea

KIT FOR JOHN DEERE C12R/612C/712C
30" Row Spacing - After Serial Number 745101

PART NO	MODEL	ROW SPACING	SERIAL NUMBER BREAK	RETAIL PRICE
84958	C12R/612C/712C	30"	After 745101	\$ 588 kit

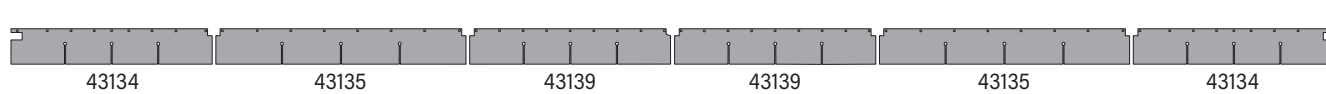

REPLACEMENT PARTS

PART NO	OEM	WIDTH	RETAIL PRICE	PART NO	OEM	WIDTH	RETAIL PRICE
43134	HXE89082	53"	\$ 76 ea	43135	HXE17918	67 1/8"	\$ 121 ea
43139	HXE30386	54"	\$ 92 ea				

KIT FOR JOHN DEERE 612FC/712FC
30" Row Spacing

PART NO	MODEL	ROW SPACING	SERIAL NUMBER BREAK	RETAIL PRICE
84497	612FC/712FC	30"	N/A	\$ 845 kit

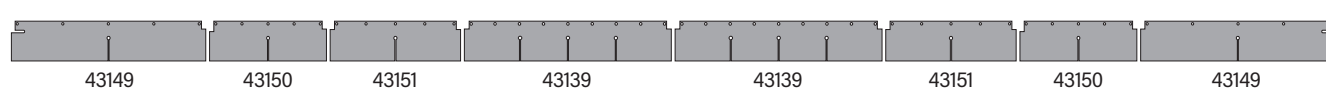

REPLACEMENT PARTS

PART NO	OEM	WIDTH	RETAIL PRICE	PART NO	OEM	WIDTH	RETAIL PRICE
43139	HXE30386	54"	\$ 92 ea	43150	5XB00758	30 1/2"	\$ 116 ea
43149	5XB00759	50 3/4"	\$ 121 ea	43151	5XB00763	34"	\$ 94 ea



Check out our website - WWW.MAYWES.COM for more information, installation instructions and our full lineup of poly products.



CROP SHIELDS / TRASH APRONS

KIT FOR JOHN DEERE C12F
30" Row Spacing

PART NO	MODEL	ROW SPACING	SERIAL NUMBER BREAK	RETAIL PRICE
84964	C12F	30"	N/A	\$ 875 kit

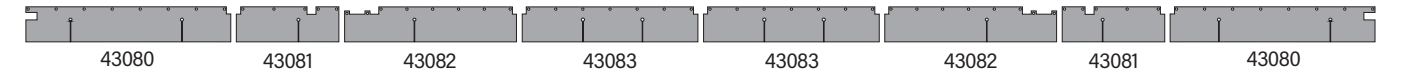

REPLACEMENT PARTS

PART NO	OEM	WIDTH	RETAIL PRICE	PART NO	OEM	WIDTH	RETAIL PRICE
43080	HXE135077	18 3/16"	\$ 133 ea	43082	HXE162042	46 5/16"	\$ 112 ea
43081	HXE162043	27 9/16"	\$ 77 ea	43083	HXE135250	47 5/16"	\$ 113 ea

KIT FOR JOHN DEERE C16R/616C/716C
30" Row Spacing

PART NO	MODEL	ROW SPACING	SERIAL NUMBER BREAK	RETAIL PRICE
84959	C16R/616C/716C	30"	N/A	\$ 1051 kit

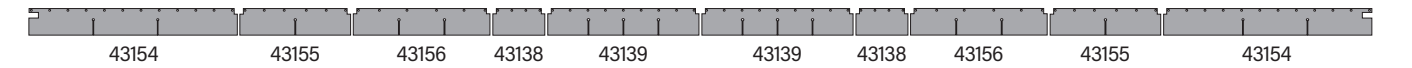

REPLACEMENT PARTS

PART NO	OEM	WIDTH	RETAIL PRICE	PART NO	OEM	WIDTH	RETAIL PRICE
43138	HXE21077	18 9/16"	\$ 66 ea	43155	HXE17919	39 1/2"	\$ 116 ea
43139	HXE30386	54"	\$ 92 ea	43156	HXE20821	48 3/4"	\$ 116 ea
43154	HXE89084	74 5/16"	\$ 134 ea				

KIT FOR JOHN DEERE C18R/618C/718C
20" Row Spacing

PART NO	MODEL	ROW SPACING	SERIAL NUMBER BREAK	RETAIL PRICE
84960	C18R/618C/718C	20"	N/A	\$ 783 kit



REPLACEMENT PARTS

PART NO	OEM	WIDTH	RETAIL PRICE	PART NO	OEM	WIDTH	RETAIL PRICE
43138	HXE21077	18 9/16"	\$ 66 ea	43156	HXE20821	48 3/4"	\$ 116 ea
43139	HXE30386	54"	\$ 92 ea	43157	HXE89085	59 1/4"	\$ 116 ea

KIT FOR JOHN DEERE C18R/618C/718C
22" Row Spacing

PART NO	MODEL	ROW SPACING	SERIAL NUMBER BREAK	RETAIL PRICE
84961	C18R/618C/718C	22"	N/A	\$ 804 kit

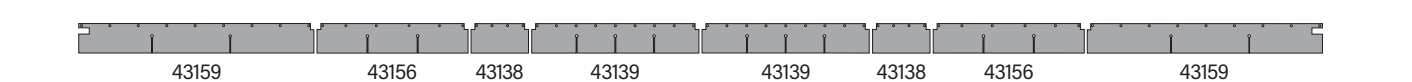

REPLACEMENT PARTS

PART NO	OEM	WIDTH	RETAIL PRICE	PART NO	OEM	WIDTH	RETAIL PRICE
43138	HXE21077	18 9/16"	\$ 66 ea	43156	HXE20821	48 3/4"	\$ 116 ea
43139	HXE30386	54"	\$ 92 ea	43159	HXE89086	75 7/8"	\$ 128 ea



C-Series OEM Stomper Covers - page 110
John Deere Row Divider Shields - page 115

CROP SHIELDS / TRASH APRONS

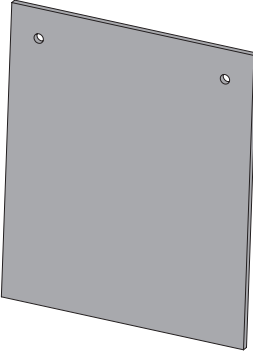
REPLACEMENT PARTS FOR CASE IH CROP SHIELD / TRASH APRON							
PART NO	OEM	CASE IH MODELS	QTY REQ	WIDTH	HEIGHT	RETAIL PRICE	
43128	48113581	4412 - 22" Spacing	25	9 11/16"	9 1/4"	\$ 37 ea	
		4418 - 20" Spacing	34				
		4418 - 22" Spacing	38				
43129	84977584	2608 - 30" Spacing	22	9 3/4"	11 11/16"	\$ 37 ea	
		2612 - 30" Spacing	34				
		4206 - 30" Spacing	14				
		4208 - 30" Spacing	22				
		4406 - 30" Spacing	16				
		4408 - 30" Spacing	22				
		4412 - 30" Spacing	32				
4416 - 30" Spacing	32						

ROW DIVIDER SHIELDS



Less Costly Repair

Costs a fraction of the price of replacing the OEM part.

Save over \$200 per row!

PART NO	DESCRIPTION	ROW SPACING	RETAIL PRICE
42760	John Deere C-Series (OEM #AXE85830)	30"	\$ 75 ea
42759	John Deere C-Series (OEM #AXE85831)	20" / 22"	\$ 75 ea
42125	John Deere 600 / 700 (OEM #AXE18146)	30"	\$ 65 ea
42124	John Deere 600 / 700 (OEM #AXE19102)	20" / 22"	\$ 65 ea

Sold per row and hardware is included (nuts & bolts).

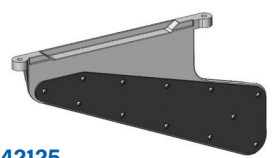
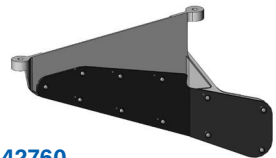
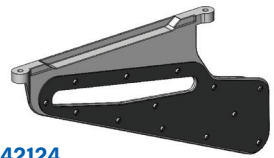
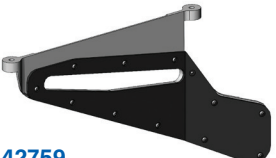
 <p>42125 30" Row Divider Shield 600/700 Series</p>	 <p>42760 30" Row Divider Shield C-Series</p>
 <p>42124 20" / 22" Row Divider Shield 600/700 Series</p>	 <p>42759 20" / 22" Row Divider Shield C-Series NEW</p>

INSTALLATION VIDEO

with MN Millennial Farmer

Scan the QR code with your phone to watch now.



INSTALLATION VIDEO

with Larson Farms

Scan the QR code with your phone to watch now.



EAR SAVERS

PREVENT LOOSE CORN EARS FROM SLIDING OVER THE GATHERING CHAINS TO THE GROUND

WHAT MAKES OUR EAR SAVERS BETTER?

- Better Memory Than Factory Rubber
- Will Not Fold Back Like Factory Ear Savers
Once the corn is in, it won't push back through the gate
- Stays Rigid and Works Like A Gate,
yet soft enough to let corn go through without knocking the ears off the corn stalk.

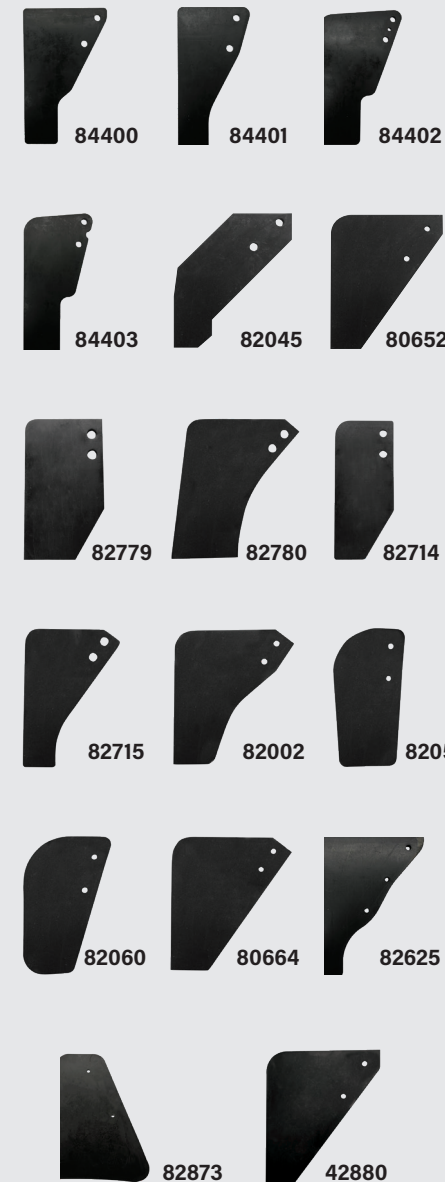

FOR CASE IH			
PART NO	DESCRIPTION	ROW SIZE	RETAIL PRICE
84400	FOR Case IH 4400 / 4200 - Inside	30"	\$ 18 ea
84401	FOR Case IH 4400 / 4200 - Outside	30"	\$ 18 ea
84402	FOR Case IH 4400 / 4200 - Inside	20" / 22"	\$ 18 ea
84403	FOR Case IH 4400 / 4200 - Outside	20" / 22"	\$ 18 ea
82045	FOR Case IH 2200 / 2400 / 3200 / 3400 / 2600	30"	\$ 18 ea
80652	FOR Case IH 800 / 900 / 1000 & GVL Poly Head	30"	\$ 18 ea
FOR NEW HOLLAND			
PART NO	DESCRIPTION	ROW SIZE	RETAIL PRICE
82045	FOR New Holland 96C / 98C / 98D / 996	-	\$ 18 ea
FOR JOHN DEERE			
PART NO	DESCRIPTION	ROW SIZE	RETAIL PRICE
82779	FOR John Deere 600 / 700 / C-Series - Outside (Extra Wide To Accommodate 22" Rows with 20" Snouts)	22"	\$ 18 ea
82780	FOR John Deere 600 / 700 / C-Series - Inside (Extra Wide To Accommodate 22" Rows with 20" Snouts)	22"	\$ 18 ea
82714	FOR John Deere 600 / 700 / C-Series - Outside	30"	\$ 18 ea
82715	FOR John Deere 600 / 700 / C-Series - Inside	30"	\$ 18 ea
82002	FOR John Deere 90 Series Poly Head (1998 & Newer)	30"	\$ 18 ea
82059	FOR John Deere 90 Series Poly Head (Inside - Prior to 1998)	30"	\$ 18 ea
82060	FOR John Deere 90 Series Poly Head (Outside - Prior to 1998)	30"	\$ 18 ea
80664	FOR John Deere 40 Series	30"	\$ 18 ea
FOR CATERPILLAR / LEXION			
PART NO	DESCRIPTION	ROW SIZE	RETAIL PRICE
82625	FOR Caterpillar / Lexion - Inside	-	\$ 18 ea
82873	FOR Caterpillar / Lexion - Outside	-	\$ 31 ea
FOR GVL POLY CORN SNOOTS			
PART NO	DESCRIPTION	ROW SIZE	RETAIL PRICE
42880	FOR GVL Poly Snouts	-	\$ 18 ea

Sold individually, 2 Ear Savers per center snout required.



AUGER TROUGH LINERS FOR GRAIN HEADS - 1/4" THICK

DURABLE POLY WON'T RUST.

May Wes Auger Trough Liners

Cover the full length of the floor under the auger - not just the feed opening.

Condensation and wet grain will not corrode poly lining when the metal is covered with poly. Even when the metal lining is corroded, the poly lining keeps loose grain from falling through rust holes and feeds grain evenly into the throat of the combine.

Poly lining is much easier to replace than factory metal. Simply drill and rivet into place.



FOR CASE IH FLEX HEAD					
DESCRIPTION	HEAD WIDTH	PART NO - GREEN	PART NO - WHITE	PART NO - RED	RETAIL PRICE
2020 Series	20'	-	83725	83729	\$ 577 kit
2020 Series	25'	-	83726	83730	\$ 783 kit
2020 Series	30'	-	83727	83731	\$ 953 kit
2020 Series	35'	-	83728	83732	\$ 1056 kit
1020 Series	15'	-	83715	83720	\$ 490 kit
1020 Series	17 1/2' & 20'	-	83716	83721	\$ 577 kit
1020 Series	22 1/2'	-	83717	83722	\$ 732 kit
1020 Series	25'	-	83718	83723	\$ 783 kit
1020 Series	30'	-	83719	83724	\$ 953 kit

FOR NEW HOLLAND FLEX HEAD					
DESCRIPTION	HEAD WIDTH	PART NO - GREEN	PART NO - WHITE	PART NO - RED	RETAIL PRICE
74C Series	20'	-	83725	-	\$ 577 kit
74C Series	25'	-	83726	-	\$ 783 kit
74C Series	30'	-	83727	-	\$ 953 kit
74C Series	35'	-	83728	-	\$ 1056 kit

FOR JOHN DEERE FLEX HEAD					
DESCRIPTION	HEAD WIDTH	PART NO - GREEN	PART NO - WHITE	PART NO - RED	RETAIL PRICE
600 Series	20'	83780	82706	-	\$ 577 kit
600 Series	22'	83781	82707	-	\$ 691 kit
600 Series	25'	83782	82708	-	\$ 773 kit
600 Series	30'	83783	82709	-	\$ 902 kit
600 Series	35'	83784	82710	-	\$ 1056 kit
200 /900 Series	13' - 16'	83785	83593	-	\$ 490 kit
200 /900 Series	18' - 20'	83786	83594	-	\$ 608 kit
200 /900 Series	22' - 24'	83787	83595	-	\$ 721 kit
200 /900 Series	25'	83788	83596	-	\$ 783 kit
200 /900 Series	30'	83789	83597	-	\$ 953 kit

Just need a single replacement panel? Order online or call May Wes at 1-800-788-6483.

QUESTIONS?

Watch our FAQ video.

Scan the code with your smartphone to watch on YouTube.



INSTALLATION VIDEO

featuring Larson Farms

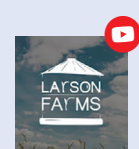

RETRACTABLE POLY FINGERS FOR GRAIN HEADS

THE COMMON SENSE AUGER FINGER REPLACEMENT CHOICE



May Wes Poly Retractable Fingers OUTPERFORM metal on multiple levels

STRONG & RESILIENT

May Wes Poly Retractable Fingers will not fray with heavy usage. These fingers are flexible and will bend past the breaking point of metal fingers.

NO HARM to your combine

Bent metal fingers can gouge and poke through the auger. Broken metal fingers can do costly damage to the drum and thresher system. The advantage poly fingers have over metal is when they eventually break, the poly will disintegrate as it passes through the combine and will not damage the internal working parts like rotors and cylinders.

COST EFFECTIVE

Poly fingers are less expensive than metal.



As Featured by Fast Ag Montana

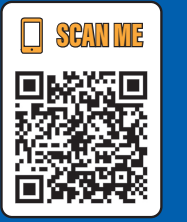

FOR CASE IH 3020 / 3016 / 3162 / 3152 SERIES - 10 1/4" LONG			FOR Case IH 3020 / 3016 / 3162 / 3152 Series
PART NO	DESCRIPTION	RETAIL PRICE	
82128	Poly Finger - 100 Fingers only	\$ 1190 pk	
82129	Poly Finger - 24 Fingers only	\$ 297 pk	
82130	Poly Finger - 12 Pack Kit	\$ 197 kit	
82131	Single Poly Finger Kit	\$ 18 kit	
41967	Single Poly Finger	\$ 14 ea	
42200	Guide Kit with Hardware	\$ 8 ea	
22407	Guide Only	\$ 5 ea	

FOR CASE IH 2020 SERIES - 10 5/8" LONG			FOR Case IH 2020 SERIES Serial #CBJ020701 & Later
PART NO	DESCRIPTION	RETAIL PRICE	
82484	Poly Finger - 100 Fingers only	\$ 1190 pk	
82483	Poly Finger - 24 Fingers only	\$ 297 pk	
82482	Poly Finger - 12 Pack Kit	\$ 197 kit	
82481	Single Poly Finger Kit	\$ 18 kit	
41488	Single Poly Finger	\$ 14 ea	
42200	Guide Kit with Hardware	\$ 8 ea	
22407	Guide Only	\$ 5 ea	

FOR CASE IH 2020 / 1020 - 10 5/8" LONG			FOR Case IH 2020 / 1020 SERIES Before Serial #CBJ020701
PART NO	DESCRIPTION	RETAIL PRICE	
82484	Poly Finger - 100 Fingers only	\$ 1190 pk	
82483	Poly Finger - 24 Fingers only	\$ 297 pk	
83469	Poly Finger - 12 Pack Kit	\$ 197 kit	
83468	Single Poly Finger Kit	\$ 18 kit	
41488	Single Poly Finger	\$ 14 ea	
40274	Guide Kit with Hardware	\$ 8 ea	
21018	Guide Only	\$ 5 ea	

FOR CASE IH 1010 / 1020 / 2162 / 2152 / 2142 SERIES - 9 1/8" LONG			FOR Case IH 1010 / 1020 / 2162 / 2152 / 2142 Series
PART NO	DESCRIPTION	RETAIL PRICE	
81369	Poly Finger - 100 Fingers only	\$ 1190 pk	
81988	Poly Finger - 24 Fingers only	\$ 297 pk	
80645	Poly Finger - 12 Pack Kit	\$ 197 kit	
80646	Single Poly Finger Kit	\$ 18 kit	
40601	Single Poly Finger	\$ 14 ea	
42200	Guide Kit with Hardware	\$ 8 ea	
22407	Guide Only	\$ 5 ea	

RETRACTABLE POLY FINGERS FOR GRAIN HEADS

FOR CASE IH 2062 /2052 /2042 SERIES - 7 7/16" LONG

PART NO	DESCRIPTION	RETAIL PRICE
82618	Poly Finger - 100 Fingers only	\$ 1406 pk
82617	Poly Finger - 24 Fingers only	\$ 347 pk
82616	Poly Finger - 12 Pack Kit	\$ 222 kit
82615	Single Poly Finger Kit	\$ 21 kit
41586	Single Poly Finger	\$ 16 ea
42200	Guide Kit with Hardware	\$ 8 ea
22407	Guide Only	\$ 5 ea

FOR Case IH
2062 /2052 /2042 Series



FOR NEW HOLLAND 740CF /760CG /790CP /880CF /840CD SERIES - 10 1/4" LONG

PART NO	DESCRIPTION	RETAIL PRICE
82128	Poly Finger - 100 Fingers only	\$ 1190 pk
82129	Poly Finger - 24 Fingers only	\$ 297 pk
82130	Poly Finger - 12 Pack Kit	\$ 197 kit
82131	Single Poly Finger Kit	\$ 18 kit
41967	Single Poly Finger	\$ 14 ea
42200	Guide Kit with Hardware	\$ 8 ea
22407	Guide Only	\$ 5 ea

FOR New Holland 740CF /760CG /
790CP /880CF /840CD SERIES



FOR NEW HOLLAND 74C SERIES - 10 5/8" LONG

PART NO	DESCRIPTION	RETAIL PRICE
82484	Poly Finger - 100 Fingers only	\$ 1190 pk
82483	Poly Finger - 24 Fingers only	\$ 297 pk
82482	Poly Finger - 12 Pack Kit	\$ 197 kit
82481	Single Poly Finger Kit	\$ 18 kit
41488	Single Poly Finger	\$ 14 ea
42200	Guide Kit with Hardware	\$ 8 ea
22407	Guide Only	\$ 5 ea

FOR New Holland 74C SERIES
Serial #PNL01781 & Later



FOR NEW HOLLAND 74C /73C SERIES - 10 5/8" LONG

PART NO	DESCRIPTION	RETAIL PRICE
82484	Poly Finger - 100 Fingers only	\$ 1190 pk
82483	Poly Finger - 24 Fingers only	\$ 297 pk
83469	Poly Finger - 12 Pack Kit	\$ 197 kit
83468	Single Poly Finger Kit	\$ 18 kit
41488	Single Poly Finger	\$ 14 ea
40274	Guide Kit with Hardware	\$ 8 ea
21018	Guide Only	\$ 5 ea

FOR New Holland 74C /73C SERIES
Before Serial #PNL01781



FOR NEW HOLLAND 86C /83C /82C SERIES - 9 1/8" LONG

PART NO	DESCRIPTION	RETAIL PRICE
81369	Poly Finger - 100 Fingers only	\$ 1190 pk
81988	Poly Finger - 24 Fingers only	\$ 297 pk
80645	Poly Finger - 12 Pack Kit	\$ 197 kit
80646	Single Poly Finger Kit	\$ 18 kit
40601	Single Poly Finger	\$ 14 ea
42200	Guide Kit with Hardware	\$ 8 ea
22407	Guide Only	\$ 5 ea

FOR New Holland
86C /83C /82C SERIES

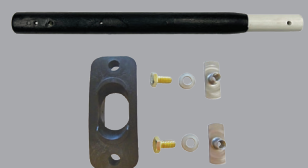

RETRACTABLE POLY FINGERS FOR GRAIN HEADS

FOR NEW HOLLAND 84C SERIES - 7 7/16" LONG

PART NO	DESCRIPTION	RETAIL PRICE
82618	Poly Finger - 100 Fingers only	\$ 1406 pk
82617	Poly Finger - 24 Fingers only	\$ 347 pk
82616	Poly Finger - 12 Pack Kit	\$ 222 kit
82615	Single Poly Finger Kit	\$ 21 kit
41586	Single Poly Finger	\$ 16 ea
42200	Guide Kit with Hardware	\$ 8 ea
22407	Guide Only	\$ 5 ea

FOR New Holland 84C SERIES



FOR NEW HOLLAND 973 /972 /971 SERIES - 10 1/4" LONG

PART NO	DESCRIPTION	RETAIL PRICE
81367	Poly Finger - 100 Fingers only	\$ 1190 pk
81364	Poly Finger - 24 Fingers only	\$ 297 pk
81935	Poly Finger - 12 Pack Kit	\$ 197 kit
81366	Single Poly Finger Kit	\$ 18 kit
40822	Single Poly Finger	\$ 14 ea
40274	Guide Kit with Hardware	\$ 8 ea
21018	Guide Only	\$ 5 ea

FOR New Holland
973 /972 /971 Series



FOR JOHN DEERE 600FD /600D /700FD /700D /RDF SERIES - 10 5/8" LONG

PART NO	DESCRIPTION	RETAIL PRICE
83524	Poly Finger - 100 Fingers only	\$ 1190 pk
83525	Poly Finger - 24 Fingers only	\$ 297 pk
83526	Poly Finger - 12 Pack Kit	\$ 197 kit
83527	Single Poly Finger Kit	\$ 18 kit
42107	Single Poly Finger	\$ 14 ea
42116	Guide Kit with Hardware	\$ 8 ea
21018	Guide Only	\$ 5 ea

FOR John Deere
600FD /600D /700FD /700D /RDF Series

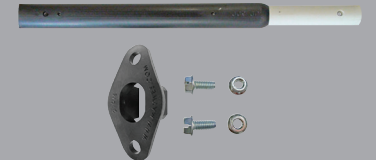

FOR JOHN DEERE 600F /600R /600P SERIES - 11 1/4" LONG

PART NO	DESCRIPTION	RETAIL PRICE
82478	Poly Finger - 100 Fingers only	\$ 1190 pk
82477	Poly Finger - 24 Fingers only	\$ 297 pk
82476	Poly Finger - 12 Pack Kit	\$ 197 kit
82475	Single Poly Finger Kit	\$ 18 kit
41489	Single Poly Finger	\$ 14 ea
40603	Guide Kit with Hardware	\$ 8 ea
21018	Guide Only	\$ 5 ea

FOR John Deere
600F /600R /600P Series



FOR JOHN DEERE 200 /900 SERIES - 10 1/4" LONG

PART NO	DESCRIPTION	RETAIL PRICE
81363	Poly Finger - 100 Fingers only	\$ 1190 pk
81990	Poly Finger - 24 Fingers only	\$ 297 pk
80649	Poly Finger - 12 Pack Kit	\$ 197 kit
80650	Single Poly Finger Kit	\$ 18 kit
40600	Single Poly Finger	\$ 14 ea
40685	Finger Hardware Kit	\$ 5 ea
40603	Guide Kit with Hardware	\$ 8 ea
21018	Guide Only	\$ 5 ea

FOR John Deere
200 /900 Series





RETRACTABLE POLY FINGERS FOR GRAIN HEADS

FOR LEXION V525 / V530 / V535 / V540 / V750 / V900 / F25 / F30 / F525 / F530 / F750 / F900 / G30 / G525 - 9 5/8" LONG

PART NO	DESCRIPTION	RETAIL PRICE
81369	Poly Finger - 100 Fingers only	\$ 1190 pk
81988	Poly Finger - 24 Fingers only	\$ 297 pk
83471	Poly Finger - 12 Pack Kit	\$ 197 kit
83472	Single Poly Finger Kit	\$ 18 kit
40601	Single Poly Finger	\$ 14 ea
40274	Guide Kit with Hardware	\$ 8 ea
21018	Guide Only	\$ 5 ea

FOR Lexion V525 / V530 / V535 / V540 / V750 / V900 / F25 / F30 / F525 / F530 / F750 / F900 / G30 / G525

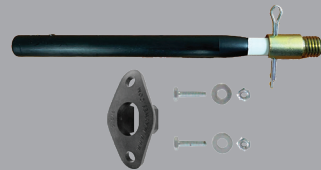

FOR LEXION V1050 / V1200 / F535 / F540 / G535 / G540 - 10 7/8" LONG

PART NO	DESCRIPTION	RETAIL PRICE
83671	Poly Finger - 100 Fingers only	\$ 1190 pk
83670	Poly Finger - 24 Fingers only	\$ 297 pk
82924	Poly Finger - 12 Pack Kit	\$ 197 kit
82925	Single Poly Finger Kit	\$ 18 kit
42291	Single Poly Finger	\$ 14 ea
40274	Guide Kit with Hardware	\$ 8 ea
21018	Guide Only	\$ 5 ea

FOR Lexion V1050 / V1200 / F535 / F540 / G535 / G540

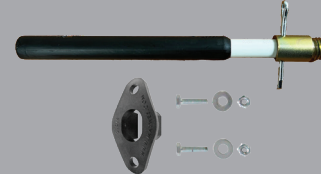

FOR GLEANER / MASSEY 700 / 800 / 7000 / 7200 / 8000 / 8200 & CHALLENGER FH / FHB - 10 15/16" LONG

PART NO	DESCRIPTION	RETAIL PRICE
83671	Poly Finger - 100 Fingers only	\$ 1190 pk
83670	Poly Finger - 24 Fingers only	\$ 297 pk
82621	Poly Finger - 12 Pack Kit	\$ 197 kit
82620	Single Poly Finger Kit	\$ 18 kit
42291	Single Poly Finger	\$ 14 ea
22174	Guide Only	\$ 5 ea
41602	Adapter Clip Kit	\$ 14 ea

FOR Gleaner / Massey 700 / 800 / 7000 / 7200 / 8000 / 8200 & Challenger FH / FHB

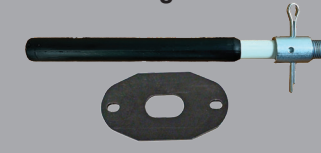

FOR GLEANER / MASSEY 7000 / 7200 / 8000 / 8200 & CHALLENGER FH / FHB - 11 7/16" LONG

PART NO	DESCRIPTION	RETAIL PRICE
82623	Poly Finger - 100 Fingers only	\$ 1190 pk
82622	Poly Finger - 24 Fingers only	\$ 297 pk
83440	Poly Finger - 12 Pack Kit	\$ 197 kit
83439	Single Poly Finger Kit	\$ 18 kit
42235	Single Poly Finger	\$ 14 ea
22174	Guide Only	\$ 5 ea
41998	Adapter Clip Kit	\$ 10 ea

FOR Gleaner / Massey 7000 / 7200 / 8000 / 8200 & Challenger FH / FHB



FOR MACDON 872 / 873 COMBINE ADAPTER (with 11" AUGER DRUM) - 7 7/16" LONG

PART NO	DESCRIPTION	RETAIL PRICE
82618	Poly Finger - 100 Fingers only	\$ 1406 pk
82617	Poly Finger - 24 Fingers only	\$ 347 pk
82616	Poly Finger - 12 Pack Kit	\$ 222 kit
82615	Single Poly Finger Kit	\$ 21 kit
41586	Single Poly Finger	\$ 16 ea
42200	Guide Kit with Hardware	\$ 8 ea
22407	Guide Only	\$ 5 ea

FOR MACDON 872 / 873



RETRACTABLE POLY FINGERS FOR GRAIN HEADS

FOR MACDON 872 COMBINE ADAPTER (with 12" AUGER DRUM) - 8 3/16" LONG

PART NO	DESCRIPTION	RETAIL PRICE
83379	Poly Finger - 100 Fingers only	\$ 1406 pk
83380	Poly Finger - 24 Fingers only	\$ 347 pk
83381	Poly Finger - 12 Pack Kit	\$ 222 kit
83382	Single Poly Finger Kit	\$ 21 kit
41997	Single Poly Finger	\$ 16 ea
42200	Guide Kit with Hardware	\$ 8 ea
22407	Guide Only	\$ 5 ea

FOR MACDON 872



FOR MACDON FM100 FLOAT MODULE

PART NO	DESCRIPTION	RETAIL PRICE
83832	Poly Finger - 100 Fingers only	\$ 1406 pk
83833	Poly Finger - 24 Fingers only	\$ 347 pk
83830	Poly Finger - 12 Pack Kit	\$ 222 kit
83831	Single Poly Finger Kit	\$ 21 kit
42466	Single Poly Finger	\$ 16 ea
42200	Guide Kit with Hardware	\$ 8 ea
22407	Guide Only	\$ 5 ea

FOR MACDON FM100 FLOAT MODULE



FOR MACDON CA20 / CA25 COMBINE ADAPTER - 9 1/8" LONG

PART NO	DESCRIPTION	RETAIL PRICE
81369	Poly Finger - 100 Fingers only	\$ 1190 pk
81988	Poly Finger - 24 Fingers only	\$ 297 pk
80645	Poly Finger - 12 Pack Kit	\$ 197 kit
80646	Single Poly Finger Kit	\$ 18 kit
40601	Single Poly Finger	\$ 14 ea
42200	Guide Kit with Hardware	\$ 8 ea
22407	Guide Only	\$ 5 ea

FOR MACDON CA20 / CA25



FOR CASE IH 2015 / 2016, MACDON PW7 / PW8, LEXION P514 / P516 / 450 SWATH UP PICKUP HEADS - 10 11/16" LONG

PART NO	DESCRIPTION	RETAIL PRICE
83629	Poly Finger - 100 Fingers only	\$ 1164 pk
83628	Poly Finger - 24 Fingers only	\$ 288 pk
83627	Poly Finger - 12 Pack Kit	\$ 197 kit
83626	Single Poly Finger Kit	\$ 18 kit
42236	Single Poly Finger	\$ 14 ea
40274	Guide Kit with Hardware	\$ 8 ea
21018	Guide Only	\$ 5 ea

FOR CASE IH 2015 / 2016, MACDON PW7 / PW8 LEXION P514 / P516 / 450 SWATH UP PICKUP HEADS

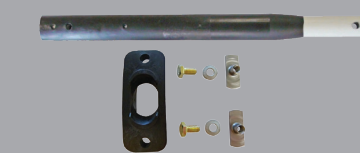

REPLACEMENT PARTS

PART NO	DESCRIPTION	RETAIL PRICE
22174	Gleaner / Massey Guide Only	\$ 5 ea
21018	Guide Only	\$ 5 ea
22407	Guide Only	\$ 5 ea
22229	Lexion - Threaded Metal Adapter	\$ 12 ea
00957	Lexion - Clip Only	\$ 2.25 ea
22132	Gleaner / Massey - Threaded Metal Adapter	\$ 11 ea
21776	Gleaner / Massey - Plastic Adapter	\$ 8 ea
00957	Gleaner / Massey - Clip Only	\$ 2.25 ea

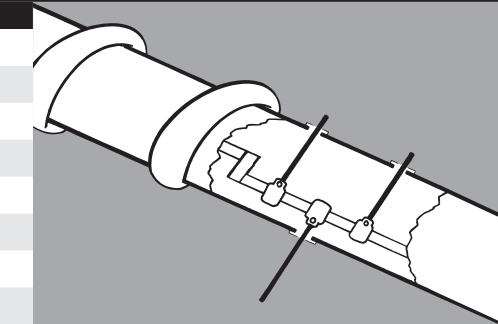

5-FINGER QUICK TINES, SNAP-ON TINES & QUICK FINGERS

Keep More Bushels In Your Machine With 5-Finger Quick Tines and Snap-On Tines

Easily slip over your existing finger attaching directly to the bar. Our unique, aggressive design helps feed short or specialty crops with ease. Great for growers experiencing severe drought.

- Attaches Directly Over Existing Mounted Finger
- No Tools Needed for Installation
- Strong, Heavy Duty Construction

INSTALLATION VIDEO

with Fast Ag Montana

Scan the QR code with your phone to watch now.



5-FINGER QUICK TINE QTY RECOMMENDED	
30' Heads need Qty of 105	40' Heads need Qty of 140
35' Heads need Qty of 125	45' Heads need Qty of 155

Based on 6" spacing and recommendation to replace every third tine. Offset placement on each consecutive bar.

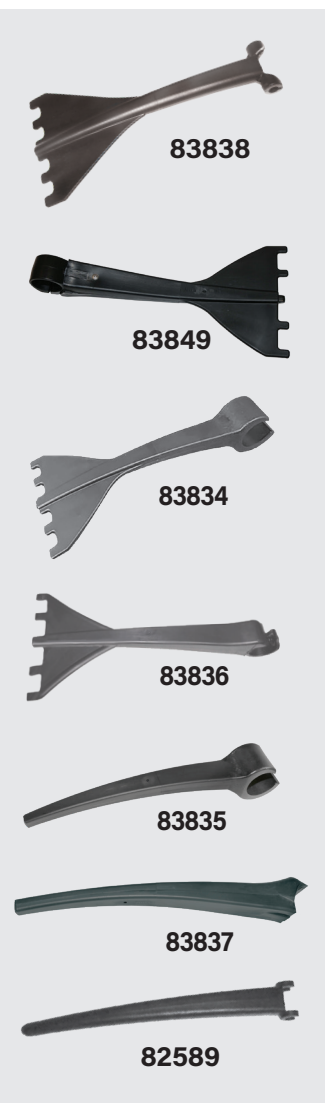

5-FINGER QUICK TINES

PART NO	DESCRIPTION	RETAIL PRICE
83838	FOR Case IH 1010 /1020 /2010 /2020 /3020* - 10 pack	\$ 64.20 pk
83849	FOR Case IH 3162 /3152 - 10 pack Requires one (1) self-tapping screw to secure the finger to the reel tine (included).	\$ 76.40 pk
83834	FOR Case IH 2162 /2152 /2142 - 10 pack	\$ 76.40 pk
83838	FOR New Holland 971 /973 /71C /72C /73C /74C /92C /94C /740C* - 10 pack	\$ 64.20 pk
83849	FOR New Holland 840CD /880CF - 10 pack Requires one (1) self-tapping screw to secure the finger to the reel tine (included).	\$ 76.40 pk
83834	FOR New Holland 86C /83C /82C - 10 pack	\$ 76.40 pk
83838	FOR John Deere 900 /900F /900R /600F /600R 600FD Before Serial Number 785000* - 10 Pack	\$ 64.20 pk
83836	FOR John Deere 630FD /635FD /640FD /645FD /730FD 735FD /740FD /745FD / After Serial Number 785000 - 10 Pack	\$ 76.40 pk
83834	FOR MacDon FD70 /FD75 /FD1 /FD2 - 10 pack	\$ 76.40 pk
83838	FOR AGCO/Gleaner 300 /400 /500 /700 /800 /8000 /8200 /9250* - 10 Pack	\$ 64.20 pk
83838	FOR Massey Ferguson 8000 /8200 /9250 /9700 /9750 /9800 /9850* - 10 Pack	\$ 64.20 pk

*Note: 83838 does not fit on Polytine Reels.

SNAP-ON TINES

PART NO	DESCRIPTION	RETAIL PRICE
83835	FOR Case IH 2162 /2152 /2142 - 10 pack	\$ 54.90 pk
83835	FOR New Holland 86C /83C /82C - 10 pack	\$ 54.90 pk
83837	FOR John Deere 630FD /635FD /640FD /645FD /730FD 735FD /740FD /745FD / After Serial Number 785000 - 10 Pack	\$ 54.90 pk
83835	FOR MacDon FD70 /FD75 /FD1 - 10 pack	\$ 54.90 pk

QUICK FINGERS

PART NO	DESCRIPTION	RETAIL PRICE
82589	Package of 10 Tines (8" Length) Fits the following: Case IH 1010 /1020 /2010 /2020 New Holland 971 /973 /71C /72C /73C /74C John Deere 900 /600 (Rigid & Flex) AGCO-Gleaner 300 /400 /500 /700 /800 Caterpillar 1998 & Later Massey Ferguson 9700 /9750 /9800 /9850	\$ 18.75 pk

POLY REEL TINES

Level II Tines	ML Tines	Polytine Tines
Standard since 2000	1989-1999	1984-1989
1 3/8" Tube with 1/2" Hex Holes Spaced 6" Apart	1 3/8" Tube with 2/5" Round Holes Spaced 4 1/2" Apart	Tines Fit Into Notches and Fastened to the Back

EASY REPLACEMENT TINES

Poly Reel Tines Replace OEM Tines
Durable Poly = Greater Strength at a Lower Weight

LEVEL II TINES - 6" SPACING

PART NO	DESCRIPTION	RETAIL PRICE
83617	Full Bat - 130 Pack	\$ 520.00 pk
83616	Full Bat - 10 Pack	\$ 46.00 pk
83615	Full Bat - Single Tine	\$ 4.80 ea
83619	LH Bat - 10 Pack	\$ 43.00 pk
83618	LH Bat - Single Tine	\$ 4.80 ea
83621	RH Bat - 10 Pack	\$ 43.00 pk
83620	RH Bat - Single Tine	\$ 4.80 ea
83623	No Bat - 10 Pack	\$ 43.00 pk
83622	No Bat - Single Tine	\$ 4.80 ea

ML TINES - 4 1/2" SPACING

PART NO	DESCRIPTION	RETAIL PRICE
83608	Full Bat - 180 Pack	\$ 560.00 pk
83607	Full Bat - 10 Pack	\$ 37.00 pk
83606	Full Bat - Single Tine	\$ 4.50 ea
83612	LH Bat - 6 Pack	\$ 22.00 pk
83611	LH Bat - Single Tine	\$ 4.80 ea
83610	RH Bat - 6 Pack	\$ 22.00 pk
83609	RH Bat - Single Tine	\$ 3.00 ea
83614	No Bat - 6 Pack	\$ 26.50 pk
83613	No Bat - Single Tine	\$ 4.80 ea

POLYTINE TINES - 4 1/2" SPACING

PART NO	DESCRIPTION	RETAIL PRICE
83603	10 Pack	\$ 33.00 pk

PADDLE TINES

HIGH PERFORMANCE TINES FOR SHORT OR SPARSE CROPS

Improved Feeding • Cleaner Cutterbar • Faster Harvesting

- 6" paddle width lifts and feeds crop that standard tines miss
- Full crop contact results in consistent feeding into the header
- Fast and easy installation

Original Tine Spacing	REEL WIDTH				
	18'	20'	25'	30'	36'
4 1/2"	73	80	98	115	136
6"	63	70	88	105	126

PART NO	DESCRIPTION	QTY	RETAIL PRICE
82905	Paddle Tine Level II Reel 1999 & Newer 6" Spacing	Pkg of 10	\$ 120.00 pk
82906	Paddle Tine ML Reel 1989 to 1999 4 1/2" Spacing	Pkg of 10	\$ 120.00 pk
82907	Paddle Tine Polytine Reel 1984 to 1989 Teardrop	Pkg of 10	\$ 120.00 pk



Hardware included

CROP DIVIDERS

TRU-TUBE® AUGER STRAIGHTENER



PART NO	DESCRIPTION	RETAIL PRICE
83843	Crop Divider for Case IH 1020 with Rods	\$ 212 pr
83841	Crop Divider for John Deere with Rods 900F / 600F / 600D / 600FD	\$ 212 pr

Replacement Parts		
PART NO	DESCRIPTION	RETAIL PRICE
42432	Replacement Marker Rod	\$ 19 ea

Straightens Damaged Auger Tubes
FITS EASILY IN YOUR TOOLBOX

PART NO	DESCRIPTION	RETAIL PRICE
81992	Tru-Tube for 12" Auger	\$ 64 ea
81993	Tru-Tube for 14" Auger (Case IH)	\$ 64 ea
81994	Tru-Tube for 16" Auger (John Deere 200/900 and Gleaner)	\$ 64 ea



POLY TIN REPLACEMENT SHIELD FOR CASE IH 1020



- Poly Replacement is 50% Lighter than Original OEM
 - Available for Head Widths Ranging from 15' to 30'
 - Kits Include:
All Replacement Panels for Head Width, Rivets, Bushings, Straps, Spacer Tool & Instructions
- Completely Replace the Metal Case IH 1020 Shield with Poly Tin Replacement Shields for Maximum Efficiency**

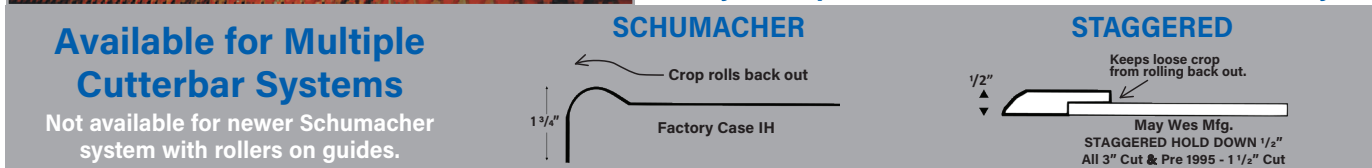

Available for Multiple Cutterbar Systems
Not available for newer Schumacher system with rollers on guides.

COMPLETE KITS				
DESCRIPTION	SIZE	PART NO STAGGERED	PART NO SCHUMACHER	RETAIL PRICE
1020	30'	80521	82027	\$ 1952 kits
1020	25'	80520	82026	\$ 1849 kits
1020	22 1/2'	80519	82025	\$ 1515 kits
1020	20'	80517	82024	\$ 1494 kits
1020	17 1/2'	80515	82023	\$ 1278 kits
1020	16 1/2'	80514	82022	\$ 1231 kits
1020	15'	80513	82021	\$ 1154 kits

REPLACEMENT PARTS - CENTER, LEFT & RIGHT				
Fits 15', 20', 22 1/2', 25' & 30' Heads				
SIZE	PART NO STAGGERED	PART NO SCHUMACHER	RETAIL PRICE	
38" Center	40469	40977	\$ 273 ea	
37" Left	40468	40976	\$ 246 ea	
37" Right	40467	40975	\$ 246 ea	
25" Left	40466	40974	\$ 246 ea	
25" Right	40465	40973	\$ 246 ea	

Fits 17 1/2' Heads Only				
SIZE	PART NO STAGGERED	PART NO SCHUMACHER	RETAIL PRICE	
38" Center	40955	40972	\$ 213 ea	
37" Left	40953	40970	\$ 226 ea	
37" Right	40952	40969	\$ 226 ea	
25" Right	40949	40966	\$ 141 ea	

REPLACEMENT PARTS - END PANELS					
SIZE	PART NO: STAGGERED		PART NO: SCHUMACHER		RETAIL PRICE
	LEFT	RIGHT	LEFT	RIGHT	
15' / 30'	40483	40487	40982	40989	\$ 246 ea
16 1/2'	40482	40486	40978	40985	\$ 313 ea
17 1/2'	40945	40485	40964	40983	\$ 313 ea
20'	40946	40484	40965	40984	\$ 313 ea
22 1/2'	40489	40488	40980	40987	\$ 313 ea
25'	40934	40933	40981	40988	\$ 246 ea

TRAILING EDGES			
PART NO	SIZE	RETAIL PRICE	
41126	46 1/2"	\$ 51 ea	
41127	43 1/2"	\$ 72 ea	
41128	40 1/2"	\$ 44 ea	
41129	35 3/4" for 37" & 38"	\$ 40 ea	
41130	34 1/2"	\$ 40 ea	
41131	28 1/2"	\$ 34 ea	
41132	23 3/4" for 25"	\$ 33 ea	

AUGER WEARSHOES



Bolt-on Poly for New or Worn Steel Auger Flighting

- Combines
- Grain Carts
- Transport Augers & More

Complete Upgrade of Combine Grain Tank when paired with GRAIN TANK AUGER TROUGH LINER - See page 93

HIGH ABRASION RESISTANCE

PROTECT METAL AGAINST WEAR & CORROSION



Typical applications include combines, grain carts, transport augers, grain bin augers and grain handling systems - wherever high volume and wear are issues.

A size to fit all
Available in different diameters, pitches and thicknesses to fit most common augers. They are pre-formed and predrilled for easy installation. They join together using a patented bevel lap joint and are bolted to the auger with special UHMW-capped bolts which are counter sunk for a smooth surface.

Smooth even flow of grain
Smooth poly provides a slick surface for grain to flow freely, reducing grain cracking, bunching and build up. The result: faster auger speeds and improved harvesting rates.

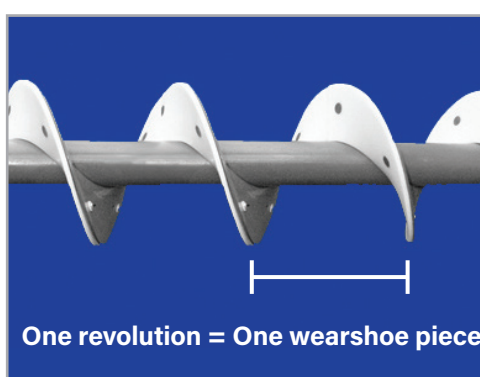

QUESTIONS?

Watch our video on how to order and install auger wearshoes.

Scan the code with your smartphone to watch on YouTube.



AUGER WEARSHOES - CUSTOM APPLICATION

SOLD PER PITCH

NOT FINDING YOUR WEARSHOE SIZE?

CUSTOM ORDERS WELCOMED

Wearshoe Ordering Information

When ordering for combines or grain carts, we will need to know the following information:

- Model Year
- Brand
- Model Number
- Type of Auger you want to cover

(Example: 1992 John Deere 9600 Tank Fill Auger)

If it is an auger size we don't have listed, we can identify the right parts with the measurements listed below:

- Flight Height**
Reference Measurement A
Note: Flight Height x 2 + Center Tube Diameter = Flighting Diameter
- Outside Diameter of Center Shaft/Tube**
Reference Measurement B
- Pitch** (Space Between Flights)
Reference Measurement C
Note: When measuring pitch, be sure to keep the tape measure parallel with the center shaft/tube.
- Left Hand or Right Hand**
Reference graphic on right to determine if you have a left hand or right hand auger.

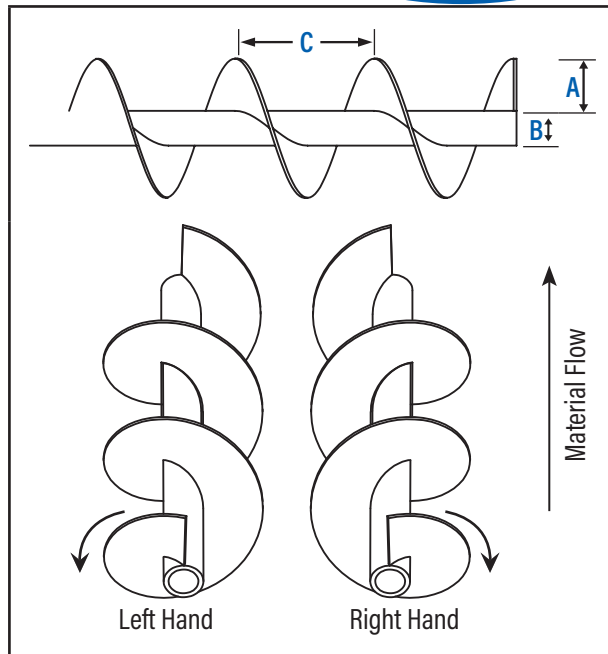

PLEASE BE ACCURATE WITH YOUR WEARSHOE ORDERING INFORMATION

A 25% RESTOCKING FEE IS CHARGED FOR ALL RETURNS ON OUR STOCK SIZES.

NO RETURNS ACCEPTED ON CUSTOM-MADE ORDERS

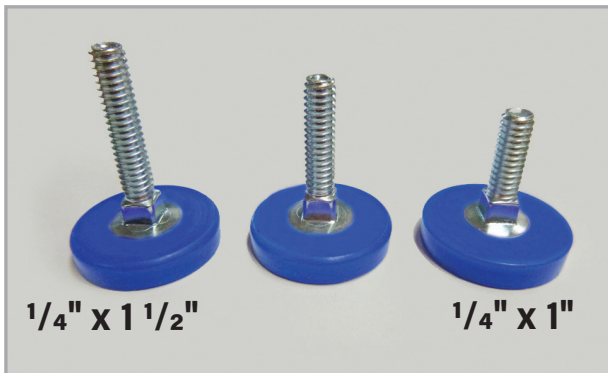

REPLACEMENT HARDWARE			
PART NO	DESCRIPTION	SIZE	RETAIL PRICE
41358	Poly-Capped Bolts	1/4" x 1"	\$ 2.30 ea
41237	Poly-Capped Bolts	1/4" x 1 1/2"	\$ 2.30 ea
00929	*Stainless Steel Hex Bolt	-	\$ 0.25 ea
01093	Zinc Coated Hex Nut	1/4"	\$ 0.12 ea

*For Lead Edge of Auger
All Auger Wearshoes include Poly Capped Bolts unless otherwise noted.

Auger dimensions will vary between models and years. Always measure for an accurate fit. Call for pricing if you don't see your exact size.

3/8" THICK UHMW WEARSHOE (Per Pitch)

Requires 3 Bolts per Pitch (Included)			
PART NO	DESCRIPTION		RETAIL PRICE
41318	6" Diameter Includes Stainless Steel Hex Bolts		\$ 15 ea
41319	7" Diameter		\$ 20 ea
41320	8" Diameter		\$ 33 ea
41321	9" Diameter		\$ 38 ea
Requires 4 Bolts per Pitch (Included)			
PART NO	DESCRIPTION		RETAIL PRICE
41322	10" Diameter		\$ 44 ea
41323	11" Diameter		\$ 47 ea
41324	12" Diameter		\$ 50 ea
41325	13" Diameter		\$ 54 ea
41326	14" Diameter		\$ 58 ea
41327	15" Diameter		\$ 62 ea
41328	16" Diameter		\$ 67 ea
41329	17" Diameter		\$ 72 ea
Requires 5 Bolts per Pitch (Included)			
PART NO	DESCRIPTION		RETAIL PRICE
41330	18" Diameter		\$ 77 ea
41331	19" Diameter		\$ 83 ea
41332	20" Diameter		\$ 89 ea
41333	21" Diameter		\$ 95 ea
41334	22" Diameter		\$ 101 ea
41335	23" Diameter		\$ 108 ea
41336	24" Diameter		\$ 116 ea

Note: Diameters 1/2" and over are priced at the next level.
Example: 9 9/16" = \$44

AUGER WEARSHOES - HARDWARE INCLUDED

FOR CASE IH - 3/8" THICK (PER PITCH)

MODEL	AUGER	TOTAL DIAMETER	SHAFT DIAMETER	PITCH	LH / RH	PIECES PER WHOLE AUGER	PART NO	RETAIL PRICE PER PITCH
9230 / 8230 7230 / 7240 7250 / 8250 9250	Tank Fill/Bubble Up	12"	3"	9 1/2"	LH	7 pcs	41873	\$ 50 ea
	Vertical Unload	14 1/2"	4 1/2"	11"	LH	6 pcs	41872	\$ 62 ea
	Hi-Capacity Vert. Unload	15 1/2"	4 1/2"	11"	LH	6 pcs	42460	\$ 65 ea
	Horizontal Unload	12 1/2"	4 1/2"	16"	LH	14 pcs	42263	\$ 54 ea
	Tank Cross	8"	2 3/8"	9"	LH	11 pcs	42269 (LH)	\$ 33 ea
		8"	2 3/8"	9"	RH	11 pcs	42268 (RH)	\$ 33 ea
7088 / 6088 5088	Hi-Capacity Tank Cross	9 1/2"	2 1/2"	10 1/4"	LH	10 pcs	43087 (LH)	\$ 44 ea
		9 1/2"	2 1/2"	10 1/4"	RH	10 pcs	43086 (RH)	\$ 44 ea
8010 / 7010 9120 / 8120 7120	Tank Fill-High Capacity	11 1/4"	3"	8 1/2"	LH	-	41868	\$ 49 ea
	Vertical Unload	14 1/2"	4 1/2"	11"	LH	-	41872	\$ 62 ea
	Horizontal Unload	12 1/2"	4 1/2"	16"	LH	14 pcs	42263	\$ 54 ea
2588 / 2577 2377 / 2388 2188 / 1688 1680	Tank Fill/Bubble Up	12"	3"	9 1/2"	LH	-	41873	\$ 50 ea
	Vertical Unload	14 1/2"	4 1/2"	11"	LH	-	41872	\$ 62 ea
	Horizontal Unload	12 1/2"	4 1/2"	16"	LH	14 pcs	42263	\$ 54 ea
	Tank Cross	8"	2 3/8"	9"	LH	11 pcs	42269 (LH)	\$ 33 ea
			8"	2 3/8"	9"	RH	11 pcs	42268 (RH)
2366 / 2344 2166 / 2144 1666 / 1660 1644 / 1640	Tank Fill/Bubble Up	9 7/8"	1 7/8"	7 3/4"	LH	5 pcs	41373	\$ 44 ea
	Horizontal Tank Fill	8 5/8"	1 5/8"	9"	LH	3 pcs	41374	\$ 37 ea
	Horizontal Unload	11 1/2"	3"	Specify	RH	-	41370	\$ 49 ea
	Vertical Unload	12"	3"	8 3/4"	RH	6 pcs	41371	\$ 50 ea
1480	Lower Clean Grain	8"	1 3/8"	8"	RH	8 pcs	41467	\$ 38 ea
	Tank Cross	7 1/4"	1 1/2"	7 1/8"	LH	-	41871 (LH)	\$ 20 ea
		7 1/4"	1 1/2"	7 1/8"	RH	-	41870 (RH)	\$ 20 ea
	Horizontal Tank Fill	7 5/8"	1 5/8"	7 1/2"	LH	3 pcs	41382	\$ 33 ea
	Horizontal Tank Fill	8 5/8"	1 5/8"	9"	LH	3 pcs	41374	\$ 37 ea
1460 / 1440	Horizontal Unload	11 1/2"	3"	Specify	RH	-	41370	\$ 49 ea
	Vertical Unload	12"	3"	8 3/4"	RH	6 pcs	41371	\$ 50 ea
	Tank Cross	7 1/4"	1 1/2"	7 1/8"	LH	-	41871 (LH)	\$ 20 ea
		7 1/4"	1 1/2"	7 1/8"	RH	-	41870 (RH)	\$ 20 ea
1460 / 1440	Horizontal Tank Fill	7 5/8"	1 5/8"	7 1/2"	LH	3 pcs	41382	\$ 33 ea
	Horizontal Unload	11 1/2"	3"	Varies 11-14"	RH	-	41370	\$ 49 ea
	Vertical Unload	12"	3"	8 3/4"	RH	6 pcs	41371	\$ 50 ea
1460 / 1440	Tank Cross	7 1/4"	1 1/2"	7 1/8"	LH	-	41871 (LH)	\$ 20 ea
		7 1/4"	1 1/2"	7 1/8"	RH	-	41870 (RH)	\$ 20 ea

FOR NEW HOLLAND - 3/8" THICK (PER PITCH)

MODEL	AUGER	TOTAL DIAMETER	SHAFT DIAMETER	PITCH	LH / RH	PIECES PER WHOLE AUGER	PART NO	RETAIL PRICE PER PITCH
CR9080 / CR9070 CR9060 / CR9040 CR970 / CR960 CR940 / CR920	Tank Fill/Bubble Up	11"	1 7/8"	8 1/4"	LH	8 pcs	42110	\$ 47 ea
	Vertical Unload	14"	4 1/2"	11"	LH	6 pcs	41872	\$ 62 ea
	Horizontal Unload	12 1/2"	4 1/2"	16"	LH	14 pcs	42263	\$ 54 ea
CR970 / CR960 CR940 / CR920	Tank Cross	8"	2 3/8"	9"	LH	11 pcs	42269 (LH)	\$ 33 ea
		8"	2 3/8"	9"	RH	11 pcs	42268 (RH)	\$ 33 ea

IN STOCK Ready to Ship
HIGHLIGHTED KITS ARE IN STOCK AND READY TO SHIP

Auger dimensions vary between models and years. Always measure for an accurate fit. Please call for pricing if you don't see your exact size.



AUGER WEARSHOES - HARDWARE INCLUDED

FOR JOHN DEERE - 3/8" THICK (PER PITCH)									
MODEL	AUGER	TOTAL DIAMETER	SHAFT DIAMETER	PITCH	LH / RH	PIECES PER WHOLE AUGER	PART NO	RETAIL PRICE PER PITCH	
S790/S780 S690/S680/S670 9870/9770	Tank Fill/Bubble Up	11"	2 1/2"	10 3/4"	RH	7 pcs*	41880	\$ 47 ea	
	*S680, S690, S780 and S790 require 8 pcs.								
	Horizontal Unload (1st Sec.)	15"	2 7/8"	16"	LH	6 pcs	41883	\$ 62 ea	
	Horizontal Unload (2nd Sec.)	15"	3 1/2"	17"	LH	-	41884	\$ 60 ea	
	Vertical Unload	15 3/4"	4 1/2"	10 1/4"	LH	5 pcs	41885	\$ 67 ea	
	Lower Clean Grain (S790/S690)	10 1/2"	2 1/4"	10 1/2"	RH	7 pcs	43091	\$ 47 ea	
	Lower Clean Grain	9 3/4"	2 1/4"	9"	RH	-	41886	\$ 44 ea	
	Tank Cross	9 1/2"	2"	11"	RH	7 pcs	41887	\$ 44 ea	
	Tank Cross	9 1/2"	2"	11"	LH	9 pcs	41887	\$ 44 ea	
S660/9670	Tank Fill/Bubble Up	10"	2 1/2"	9 1/2"	RH	8 pcs	41426	\$ 44 ea	
	Vertical Unload	15 3/4"	4 1/2"	10 1/4"	LH	5 pcs	41885	\$ 67 ea	
	Horizontal Unload (1st Sec.)	15"	2 7/8"	16"	LH	6 pcs	41883	\$ 62 ea	
	Horizontal Unload (2nd Sec.)	15"	3 1/2"	17"	LH	-	41884	\$ 60 ea	
	Tank Cross	9 1/2"	2"	11"	LH & RH	11 pcs	41887	\$ 44 ea	
	Lower Clean Grain	8 3/4"	1 9/16"	8 3/4"	RH	-	41882	\$ 38 ea	
	Tank Fill/Bubble Up	10"	2 1/2"	9 1/2"	RH	8 pcs	41426	\$ 44 ea	
9860/9760 9660	Vertical Unload	13"	4 1/2"	9"	LH	6 pcs	41432	\$ 54 ea	
	Horizontal Unload (1st Sec.)	12"	2 7/8"	13"	LH	5 pcs	41431	\$ 50 ea	
	Horizontal Unload (2nd Sec.)	11 3/4"	3 1/2"	13"	LH	-	41462	\$ 50 ea	
	Tank Cross	7 1/2"	2"	8 3/4"	LH	11 pcs	41449	\$ 33 ea	
	Tank Cross	7 1/2"	2"	8 3/4"	RH	11 pcs	41450	\$ 33 ea	
	Hi-Cap Horiz. Unload (1st Sec.)	15"	2 7/8"	16"	LH	6 pcs	41883	\$ 62 ea	
	Hi-Cap Horiz. Unload (2nd Sec.)	15"	3 1/2"	17"	LH	-	41884	\$ 60 ea	
	Hi-Cap Horiz. Unload (3rd Sec.)	15"	3 1/2"	17"	LH	-	41884	\$ 60 ea	
	Hi-Cap Vertical Unload	15 3/4"	4 1/2"	10 1/4"	LH	5 pcs	41885	\$ 67 ea	
	Hi-Cap Tank Cross	9 1/2"	2"	11"	RH	7 pcs	41887	\$ 44 ea	
	Hi-Cap Tank Cross	9 1/2"	2"	11"	LH	9 pcs	41887	\$ 44 ea	
	Lower Clean Grain	8 3/4"	1 9/16"	8 3/4"	RH	-	41882	\$ 38 ea	
S650/S550 9570/9560	Tank Fill/Bubble Up	10"	2 1/2"	9 1/2"	RH	8 pcs	41426	\$ 44 ea	
	Vertical Unload	13"	4 1/2"	9"	LH	6 pcs	41432	\$ 54 ea	
	Horiz. Unload (1st Sec.)	12"	2 7/8"	13"	LH	5 pcs	41431	\$ 50 ea	
	Horiz. Unload (2nd Sec.)	11 3/4"	3 1/2"	13"	LH	-	41462	\$ 50 ea	
	Lower Clean Grain	8 9/16"	1 3/8"	6 1/2"	RH	10 pcs	41421	\$ 38 ea	
9750/9650	Tank Fill/Bubble Up	10"	2 1/2"	9 1/2"	RH	8 pcs	41426	\$ 44 ea	
	Vertical Unload	13"	4 1/2"	9"	LH	6 pcs	41432	\$ 54 ea	
	Horiz. Unload (1st Sec.)	12"	2 7/8"	13"	LH	5 pcs	41431	\$ 50 ea	
	Horiz. Unload (2nd Sec.)	11 3/4"	3 1/2"	13"	LH	-	41462	\$ 50 ea	
	Lower Clean Grain	8 3/4"	1 9/16"	8"	RH	-	41881	\$ 37 ea	
	Tank Cross	7 1/2"	2"	8 3/4"	LH	11 pcs	41449	\$ 33 ea	
	Tank Cross	7 1/2"	2"	8 3/4"	RH	11 pcs	41450	\$ 33 ea	
9550/9450	Tank Fill/Bubble Up	10"	2 1/2"	9 1/2"	RH	8 pcs	41426	\$ 44 ea	
	Vertical Unload	13"	4 1/2"	9"	LH	6 pcs	41432	\$ 54 ea	
	Horiz. Unload (1st Sec.)	12"	2 7/8"	13"	LH	5 pcs	41431	\$ 50 ea	
	Horiz. Unload (2nd Sec.)	11 3/4"	3 1/2"	13"	LH	-	41462	\$ 50 ea	
	Lower Clean Grain	8 9/16"	1 3/8"	6 1/2"	RH	10 pcs	41421	\$ 38 ea	
	Tank Cross	7 1/2"	2"	8 3/4"	LH	11 pcs	41449	\$ 33 ea	
Tank Cross	7 1/2"	2"	8 3/4"	RH	11 pcs	41450	\$ 33 ea		

IN STOCK Ready to Ship
HIGHLIGHTED KITS ARE IN STOCK AND READY TO SHIP

Auger dimensions vary between models and years. Always measure for an accurate fit. Please call for pricing if you don't see your exact size.



AUGER WEARSHOES - HARDWARE INCLUDED

FOR JOHN DEERE - 3/8" THICK (PER PITCH)								
MODEL	AUGER	TOTAL DIAMETER	SHAFT DIAMETER	PITCH	LH / RH	PIECES PER WHOLE AUGER	PART NO	RETAIL PRICE PER PITCH
9510/9410	Tank Fill/Bubble Up	8 1/2"	2 1/2"	7 1/2"	RH	8 pcs	41427	\$ 38 ea
	Vertical Unload	13"	4 1/2"	9"	LH	7 pcs	41432	\$ 54 ea
	Horiz. Unload (1st Sec.)	12"	2 7/8"	13"	LH	5 pcs	41431	\$ 50 ea
	Horiz. Unload (2nd Sec.)	11 3/4"	3 1/2"	13"	LH	-	41462	\$ 50 ea
	Tank Cross	7 1/2"	2"	8 3/4"	LH	11 pcs	41449	\$ 33 ea
	Tank Cross	7 1/2"	2"	8 3/4"	RH	11 pcs	41450	\$ 33 ea
9610/9600	*Early Tank Fill/Bubble Up	8"	2 1/2"	8 1/4"	RH	8 pcs	41463	\$ 38 ea
	*Late Tank Fill/Bubble Up	9 1/4"	2 1/2"	8 1/4"	RH	8 pcs	41464	\$ 38 ea
	Vert. Unload	13"	4 1/2"	9 1/4"	LH	7 pcs	41432	\$ 54 ea
	Horiz. Unload (1st Sec.)	12"	2 7/8"	13"	LH	5 pcs	41431	\$ 50 ea
	Horiz. Unload (2nd Sec.)	11 3/4"	3 1/2"	13"	LH	-	41462	\$ 50 ea
	Tank Cross	7 1/2"	2"	8 3/4"	LH	11 pcs	41449	\$ 33 ea
Tank Cross	7 1/2"	2"	8 3/4"	RH	11 pcs	41450	\$ 33 ea	
9500/9400	*Early Tank Fill/Bubble Up	7 1/4"	2 1/2"	8 1/4"	RH	8 pcs	41461	\$ 20 ea
	*Late Tank Fill/Bubble Up	8 1/2"	2 1/2"	7 1/2"	RH	8 pcs	41427	\$ 38 ea
	Vertical Unload	13"	4 1/2"	9"	LH	7 pcs	41432	\$ 54 ea
	Horiz. Unload (1st Sec.)	12"	2 7/8"	13"	LH	5 pcs	41431	\$ 50 ea
	Horiz. Unload (2nd Sec.)	11 3/4"	3 1/2"	13"	LH	-	41462	\$ 50 ea
	Tank Cross	7 1/2"	2"	8 3/4"	LH	11 pcs	41449	\$ 33 ea
Tank Cross	7 1/2"	2"	8 3/4"	RH	11 pcs	41450	\$ 33 ea	
8820/7720	Tank Fill/Bubble Up	8"	1 3/4"	8 1/4"	LH	-	41425	\$ 33 ea
	Vertical Unload	13"	4 1/2"	9"	LH	-	41432	\$ 54 ea
	Horiz. Unload	11 3/4"	3 1/2"	13"	LH	-	41462	\$ 50 ea
	Tank Cross	7 1/2"	2 1/2"	4 1/2"	LH	-	41459	\$ 33 ea
6620	Tank Fill/Bubble Up	6 3/4"	1 11/16"	7 1/2"	LH	8 pcs	41454	\$ 29 ea
	Vertical Unload	13"	4 1/2"	9"	LH	-	41432	\$ 54 ea
	Horiz. Unload	12"	2 7/8"	13"	LH	-	41431	\$ 50 ea
	Tank Cross	7 1/2"	2 1/2"	4 1/2"	LH	-	41892	\$ 33 ea
	Tailings	4 1/4"	1"	5 1/4"	LH	-	42278	\$ 15 ea
1293	Corn Head	16"	6"	22"	LH & RH	-	41889	\$ 64 ea
920	Flex Platform Head	24"	16"	27"	LH	-	42281 (LH)	\$ 110 ea
		24"	16"	27"	RH	-	42280 (RH)	\$ 110 ea
894	Corn Head	16"	8"	22"	LH & RH	-	41891	\$ 64 ea
693	Corn Head	16"	6"	18"	LH & RH	-	41890	\$ 64 ea
		16"	6"	22"	LH & RH	-	41889	\$ 64 ea
863/643	Corn Head	14"	6"	18"	LH	-	41444 (LH)	\$ 56 ea
		14"	6"	18"	RH	-	41445 (RH)	\$ 56 ea
444	Corn Head	17"	6"	19"	LH	-	41442 (LH)	\$ 69 ea
		17"	6"	19"	RH	-	41443 (RH)	\$ 69 ea

*Early 9400 Models have Serial Numbers through 640100 (All 1989 & Some 1990 Models)

*Early 9500 Models have Serial Numbers through 640200 (All 1989 & Some 1990 Models)

*Late 9400 Models have Serial Numbers 640101 & Higher (Some 1990 & All 1991-Later)

*Late 9500 Models have Serial Numbers & Higher (Some 1990 & All 1991-Later)

*Early 9600 Models have Serial Numbers through 640300 (All 1989 & Some 1990 Models)

*Late 9600 models have Serial Numbers 640301 & Higher (Some 1990 & All 1991-Later)

FOR GLEANER - 3/8" THICK (PER PITCH)								
MODEL	AUGER	TOTAL DIAMETER	SHAFT DIAMETER	PITCH	LH / RH	PIECES PER WHOLE AUGER	PART NO	RETAIL PRICE PER PITCH
R65	Horiz. Unload	12 7/8"	2 7/8"	11 1/4"	LH	-	41555	\$ 33 ea
R62	Tank Fill/Bubble Up	8 1/2"	1 1/2"	8"	LH	-	41543	\$ 33 ea
	Vertical Unload	13"	5"	8 1/4"	LH	-	41552	\$ 53 ea
R60	Tank Cross	10"	2 3/8"	10 1/2"	LH	8 pcs	41553	\$ 43 ea
	Tank Fill/Bubble Up	8 1/4"	1 1/4"	8"	LH	-	41542	\$ 33 ea
R52	Tank Fill/Bubble Up	8 1/4"	1 1/4"	8"	LH	-	41542	\$ 33 ea

Auger dimensions vary between models and years. Always measure for an accurate fit. Please call for pricing if you don't see your exact size.

AUGER WEARSHOES



AUGER WEARSHOES - HARDWARE INCLUDED

FOR MASSEY FERGUSON - 3/8" THICK (PER PITCH)								
MODEL	AUGER	TOTAL DIAMETER	SHAFT DIAMETER	PITCH	LH / RH	PIECES PER WHOLE AUGER	PART NO	RETAIL PRICE PER PITCH
8780	XP Tank Fill/Bubble Up	8 1/2"	1 1/4"	8 1/2"	LH	-	41876	\$ 37 ea
	Vertical Unload	14"	6"	10 1/2"	LH	-	41879	\$ 56 ea
	Horiz. Unload	12"	3"	10"	LH	-	41874	\$ 49 ea
8570	Tank Fill/Bubble Up	8"	1 3/4"	8"	LH	-	41545	\$ 33 ea
	Vertical Unload	14"	6"	10"	LH	-	41556	\$ 56 ea
	Lower Clean Grain	8"	1 1/2"	8"	RH	-	41546	\$ 33 ea
	Tank Cross	8 1/4"	2 3/8"	8 1/4"	LH	-	41547	\$ 33 ea
	Horiz. Unload	11"	2 7/8"	11 1/2"	LH	-	41875	\$ 46 ea
8460 / 8450	Tank Fill/Bubble Up	9"	1 7/8"	6"	LH	-	41878	\$ 37 ea

AUGER WEARSHOES FOR GRAIN CARTS - HARDWARE INCLUDED

FOR JOHN DEERE GRAIN CARTS - 3/8" THICK (PER PITCH)								
MODEL	AUGER	TOTAL DIAMETER	SHAFT DIAMETER	PITCH	LH / RH	PIECES PER WHOLE AUGER	PART NO	RETAIL PRICE PER PITCH
500	Vertical	14"	3"	12 1/2"	LH	17 Pcs (8 Bot / 9 Top)	42275	\$ 56 ea
400	Horizontal	9"	3"	6 1/4"	LH	-	41436	\$ 37 ea
	Vertical	12"	2 7/8"	8 1/4"	LH	-	42273	\$ 49 ea
1210A	Horizontal	9"	3"	6 1/4"	LH	-	41436	\$ 37 ea
	Vertical	11 5/8"	2 7/8"	8 3/4"	LH	-	41437	\$ 49 ea

FOR BRENT GRAIN CARTS - 3/8" THICK (PER PITCH)								
MODEL	AUGER	TOTAL DIAMETER	SHAFT DIAMETER	PITCH	LH / RH	PIECES PER WHOLE AUGER	PART NO	RETAIL PRICE PER PITCH
1596 / 1594 / 1396 1394 / 1196 / 1194	Horizontal	19"	5"	20"	LH	12 pcs (6 Frn / 5 Bck)	42274	\$ 79 ea
	Vertical	20 1/2"	6"	21"	LH (Tilt)	9 pcs (4 Bot / 5 Top)	42271	\$ 95 ea
1084 Avalanche	Horizontal	17"	5"	17 3/4"	LH	-	42272	\$ 64 ea
	Vertical	19"	5"	19"	RH	9 pcs (4 Bot / 5 Top)	41893	\$ 83 ea
1386 / 1186	Lower	20 1/2"	6"	21"	RH (Tilt)	8 pcs	42279	\$ 84 ea
	Upper	18 1/2"	5"	19"	RH (Tilt)	9 pcs	41894	\$ 83 ea
1082 / 1080 / 882 / 880	-	18 1/2"	5"	19"	RH (Tilt)	17 pcs (8 Bot / 9 Top)	41894	\$ 83 ea
780	-	17"	5"	17 1/2"	RH (Tilt)	17 pcs (9 Bot / 8 Top)	41895	\$ 72 ea
974 / 874 / 774 / 674 / 574	-	16"	5"	17"	RH	17 pcs	41896	\$ 67 ea
772 / 672 / 572 / 472	Lower	13"	3"	13"	RH	-	41898	\$ 53 ea
	Upper	13"	3 1/2"	13"	RH	-	41899	\$ 53 ea
770 / 670 / 570 / 470	-	13"	3"	13"	LH	-	41897	\$ 53 ea

FOR J & M GRAIN CARTS - 3/8" THICK (PER PITCH)								
MODEL	AUGER	TOTAL DIAMETER	SHAFT DIAMETER	PITCH	LH / RH	PIECES PER WHOLE AUGER	PART NO	RETAIL PRICE PER PITCH
1050 / 1150 / 1010	-	19"	4 1/2"	19"	RH	-	41900	\$ 83 ea
1110 / 1310 / 1410 / 1120 / 1220 1520 / 1051 / 1151 / 1326 / 1401	-	21 1/8"	6"	21"	RH (Tilt)	14 pcs (8 Bot / 6 Top)	41901	\$ 90 ea
1075	-	15"	2 7/8"	15"	RH	15 pcs	41902	\$ 62 ea
	-	17 1/8"	4 1/2"	17"	RH	13 pcs	41903	\$ 72 ea
	-	21"	6"	21"	RH	11 pcs	41904	\$ 95 ea
1000	-	19"	4 1/2"	19"	RH	-	41900	\$ 83 ea
875	-	15"	2 7/8"	15"	RH	15 pcs	41902	\$ 62 ea
810	-	17 1/8"	4 1/2"	17"	RH	13 pcs	41903	\$ 72 ea
	-	17 1/8"	4 1/2"	17"	RH	13 pcs	41903	\$ 72 ea
750	-	13"	2 7/8"	13"	RH	17 pcs	41905	\$ 54 ea
	-	15"	2 7/8"	15"	RH	15 pcs	41902	\$ 62 ea
	-	17 1/8"	4 1/2"	17"	RH	13 pcs	41903	\$ 72 ea
525 / 620 / 650 / 675	-	13"	2 7/8"	13"	RH	17 pcs	41905	\$ 54 ea
525	Gear Drive	13"	2 7/8"	13"	LH	17 pcs	41906	\$ 53 ea



AUGER WEARSHOES FOR GRAIN CARTS - HARDWARE INCLUDED

FOR KINZE GRAIN CARTS - 3/8" THICK (PER PITCH)								
MODEL	AUGER	TOTAL DIAMETER	SHAFT DIAMETER	PITCH	LH / RH	PIECES PER WHOLE AUGER	PART NO	RETAIL PRICE PER PITCH
1500 / 1300 1100	Horizontal Back	20"	8"	21"	LH	9 pcs	42277	\$ 84 ea
	Horizontal Front	20"	8"	21"	LH	4 pcs	42277	\$ 84 ea
	Vertical	22"	8"	23"	LH	10 pcs	42233	\$ 101 ea
1050	Vertical	20"	8"	21 1/4"	LH	9 pcs	41933	\$ 95 ea
	Early Horiz. Front Section	16"	7"	17"	LH	9 pcs	41930	\$ 64 ea
	Early Horiz. Back Section	16"	7"	9"	LH	11 pcs	41929	\$ 64 ea
	Late Horiz. Front Section	16 3/4"	8"	17"	LH	9 pcs	41932	\$ 72 ea
	Late Horiz. Back Section	16 3/4"	8"	9"	LH	11 pcs	41931	\$ 72 ea
1040	Horizontal Back Section	12"	2 7/8"	8"	LH	12 pcs	41918	\$ 50 ea
	Vertical	18"	8"	21"	LH	9 pcs (4 Bot / 5 Top)	41926	\$ 77 ea
850	Horizontal Back Section	15"	7"	9"	LH	14 pcs	41927	\$ 60 ea
	Horizontal Front Section	15"	7"	15"	LH	6 pcs	41928	\$ 60 ea
840	Horizontal Front Section	12"	3 1/2"	12"	LH	10 pcs	41923	\$ 49 ea
800	Vertical	16"	4 1/2"	16"	RH	9 pcs (4 Bot / 5 Top)	41917	\$ 67 ea
	Vertical	16"	8"	16"	LH	12 pcs (5 Bot / 7 Top)	41922	\$ 64 ea
650	Horizontal	14"	7"	15 1/2"	LH	-	41921	\$ 56 ea
	Vertical	14 1/8"	2 7/8"	14"	RH	11 pcs	41920	\$ 58 ea
640	Horizontal Front Section	12"	2 7/8"	12"	LH	-	41919	\$ 50 ea
	Horizontal Back Section	12"	2 7/8"	8"	LH	-	41918	\$ 50 ea
600	Heavy Duty Vertical	16"	4 1/2"	16"	RH	9 pcs	41917	\$ 67 ea
	Vertical	12"	2 7/8"	12"	RH	13 pcs (6 Bot / 7 Top)	41916	\$ 49 ea

FOR PARKER GRAIN CARTS - 3/8" THICK (PER PITCH)								
MODEL	AUGER	TOTAL DIAMETER	SHAFT DIAMETER	PITCH	LH / RH	PIECES PER WHOLE AUGER	PART NO	RETAIL PRICE PER PITCH
838 / 938	-	16 1/2"	5"	17 1/2"	LH	-	41938	\$ 69 ea
710 / 810 / 1010	-	16"	4"	16"	RH	-	41936	\$ 64 ea
500	-	13"	2 7/8"	13"	RH	-	41905	\$ 54 ea
450	-	12"	2 7/8"	8 1/4"	RH	20 pcs	41934	\$ 49 ea

FOR KILLBROS GRAIN CARTS - 3/8" THICK (PER PITCH)								
MODEL	AUGER	TOTAL DIAMETER	SHAFT DIAMETER	PITCH	LH / RH	PIECES PER WHOLE AUGER	PART NO	RETAIL PRICE PER PITCH
1160	Vertical (Bottom)	13"	3"	13"	RH	9 pcs (bottom)	41911	\$ 53 ea
1150	Vertical (Top)	13"	3 1/2"	13"	RH	10 pcs (top)	41912	\$ 53 ea
1820	Horizontal (Front)	12"	3"	12"	LH	-	41913	\$ 49 ea
	Horizontal (Back)	12"	3"	6"	LH	-	41914	\$ 49 ea
1800	Vertical	15"	3"	15"	RH	6 pcs (bottom)	41910	\$ 60 ea
1600	Vertical	15"	3"	15"	RH	-	41910	\$ 60 ea
	Horizontal	12"	3"	12"	LH	-	41913	\$ 49 ea
1400	Horizontal	10"	2 3/8"	10"	LH	12 pcs (front)	41863	\$ 43 ea
1200	Vertical	12"	2 3/8"	12"	RH	16 pcs (7 Bot / 9 Top)	41915	\$ 49 ea

Auger dimensions vary between models and years. Always measure for an accurate fit. Please call for pricing if you don't see your exact size.



AUGER TUBE LINERS
Protect your auger tube from corrosion & wear.

Find them on page 94

G4 PLANTER STALK STOMPERS



PROTECT YOUR PLANTER TIRES FROM STUBBLE DAMAGE. INSTALL MAY WES G4 PLANTER STALK STOMPERS!

USES THE SAME POLY SHOES AS OUR G4 CORN HEAD STALK STOMPERS.

KIT FOR CASE IH 1250 EARLY RISER

PART NO	DESCRIPTION	RETAIL PRICE
83821	4 Row Kit	\$ 1674 ea

REPLACEMENT PARTS FOR CASE IH 1250 EARLY RISER

PART NO	DESCRIPTION	RETAIL PRICE
43119	Mount Bracket Assembly	\$ 301 ea

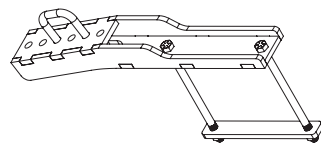

KIT FOR JOHN DEERE 1770 NT

PART NO	DESCRIPTION	RETAIL PRICE
83820	4 Row Kit	\$ 1674 ea

REPLACEMENT PARTS FOR JOHN DEERE 1770 NT

PART NO	DESCRIPTION	RETAIL PRICE
43118	Mount Bracket Assembly	\$ 301 ea

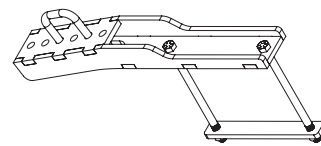

REPLACEMENT PARTS FOR BOTH

PART NO	DESCRIPTION	RETAIL PRICE
24100	12" Shoe	\$ 148 ea



PART NO	DESCRIPTION	RETAIL PRICE
41672	2x2 Toolbar - 72"	\$ 124 ea

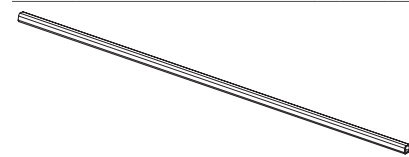

- Levels Stalks to Protect the Planter Tires
- 12" Durable Compression Molded UHMW Shoes
- Easily Bolts to Frame
- Simplified Design
- Hardware Included
- Made in the U.S.A.



SHANK SAVERS - 1/4" THICK

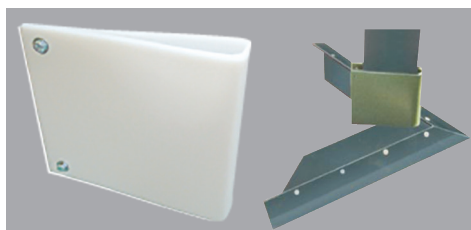

CREATE IDEAL SOIL CONDITIONS

POLY SHANK SAVERS FOR SWEEP PLOWS

PART NO	DESCRIPTION	SIZE	RETAIL PRICE
80688	Undercutter V-Plow	9 1/2" x 22"	\$ 42 ea

As the V-plow undercuts the ground, the poly Shank Saver lessens the furrowing of the soil. It helps keep the top soil undisturbed as well as creates a uniform and shallow depth on final operation before planting. Shields are large enough for the anhydrous sprayer tubes to fit between the Shank Saver and the shank.

PRO CHUTE



Slide Gate Controls Flow

PART NO	DESCRIPTION	SIZE	RETAIL PRICE
82652	PRO Chute - Yellow	7 1/2" x 62"	\$ 525 ea
82653	PRO Chute II - Blue	10 1/2" x 62"	\$ 525 ea

EMPTY SEED BOXES DIRECTLY INTO YOUR PLANTER

- Made of UHMW
- Empty Seed Box in as little as Two Minutes with PRO Chute II
- Snaps onto Seed Box Quickly
- 79" of Clearance from Lift to End for Maximum Clearance

SHANK PROTECTORS - 1/4" THICK



PROTECT CRITICAL STRESS POINT ON METAL SHANK FROM EXCESSIVE WEAR

As soil conditions vary from field to field, you can protect from abrasion and prevent build-up of mud and residue by covering with May Wes Non-Stick Poly Shank Protectors.

OPERATE EFFICIENTLY & SAVE FUEL

The non-stick poly surface lets the shank and attached shovel glide through sticky soil. It resists friction that causes dragging when cultivating and digging.

SIZE SPECIFICATIONS

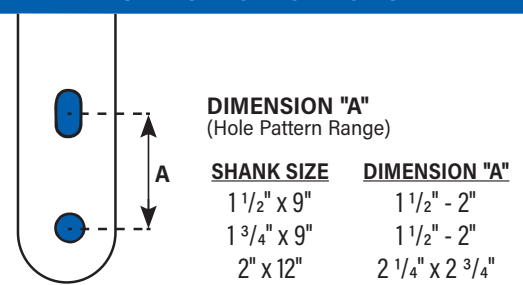

SHANK PROTECTORS - PACKS OF 100

DESCRIPTION	PART NO WHITE	RETAIL PRICE	PART NO SILVER	PART NO BLACK	RETAIL PRICE
1 1/2" x 9"	80682	\$ 217 ea	81592	82108	\$ 217 ea
1 3/4" x 9"	80683	\$ 230 ea	80554	82109	\$ 230 ea
2" x 12"	80685	\$ 315 ea	80807	82110	\$ 315 ea

SHANK PROTECTORS - PACKS OF 25

DESCRIPTION	PART NO WHITE	RETAIL PRICE	PART NO SILVER	PART NO BLACK	RETAIL PRICE
1 1/2" x 9"	82263	\$ 63 ea	82269	82460	\$ 63 ea
1 3/4" x 9"	82264	\$ 68 ea	82270	82461	\$ 68 ea
2" x 12"	82265	\$ 83 ea	82271	82462	\$ 83 ea

RAPID DRAIN FILTER TILE INLET

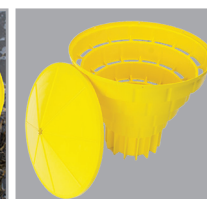

MAXIMUM DRAINAGE

PART NO	DESCRIPTION	RETAIL PRICE
82656	Rapid Drain: Low Profile - 6" Dual Wall	\$ 43 ea
82657	Rapid Drain: Low Profile - 8" Dual Wall	\$ 50 ea

When residue clogs up intakes, field drainage can be a time-consuming issue. The patented no-clog design allows for maximum tile flow.

Featured by the Minnesota Millennial Farmer [youtube.com/MNMillennialFarmer](https://www.youtube.com/MNMillennialFarmer)

RAPID DRAIN FILTER RISER



- Rapid Drain Riser Jr. is 15" Overall Height
- Rapid Drain Risers are 34" Overall Height
- High Visibility Yellow can be easily seen as a marker
- UV Stabilized Polypropylene

HIGH VISIBILITY PREVENTS CLOGGING

PART NO	DESCRIPTION	RETAIL PRICE
83644	Rapid Drain Riser Jr. - 6" Body	\$ 34.00 ea
83643	Rapid Drain Riser - 6" Body / 6" Inlet	\$ 41.00 ea
82981	Rapid Drain Riser - 10" Body / 6" Inlet	\$ 46.00 ea
82982	Rapid Drain Riser - 10" Body / 8" Inlet	\$ 55.20 ea



SEEDRIGHT™ SEED PLATES **NEW**

TRANSFORM YOUR PLANTER

Plant small grains, wheat and cover crop mixes with your planter versus using a drill or air seeder.



QUESTIONS?



Scan the code to learn more.

SEEDRIGHT™ SEED PLATES

PART NO	DESCRIPTION	RETAIL PRICE
84035	John Deere Large Cell For John Deere vacuum planters (excluding ExactEmerge)	\$ 46 ea
84036	John Deere Small Cell For John Deere vacuum planters (excluding ExactEmerge)	\$ 46 ea
84037	Kinze Large Cell For Kinze EdgeVac vacuum planters	\$ 46 ea
84038	Kinze Small Cell For Kinze EdgeVac vacuum planters	\$ 46 ea
84039	Kinze Backer Plate For Kinze Brush Type mechanical planters	\$ 37 ea
84040	Precision Planting Large Cell For Precision Planting meters	\$ 39 ea
84041	Precision Planting Bundle Drop Kit Includes BundleDrop soybean plate and Knocker Wheel to prevent crusting	\$ 54 ea

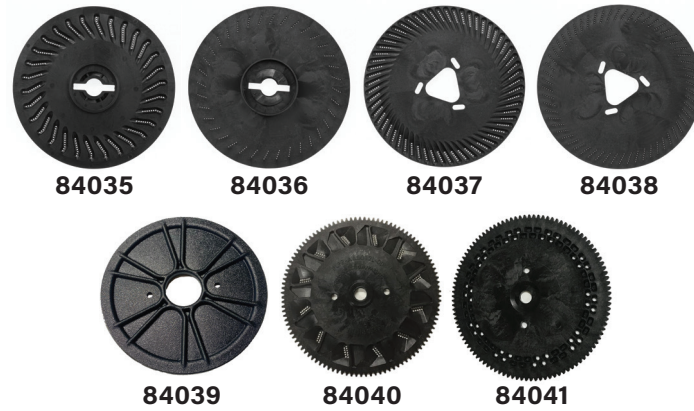

84035 84036 84037 84038
84039 84040 84041

Images not shown to scale.

GAUGE & PRESS WHEEL SCRAPERS

Spend more time on your tractor with no time lost cleaning your gauge and press wheels.

NO DOWN TIME EQUALS MORE ACRES PLANTED PER DAY



FOR CASE IH GAUGE WHEELS		
PART NO	DESCRIPTION	RETAIL PRICE
42338	Left Mount Bracket with Scraper for 2100 /1200 (2002 & Newer)	\$ 45 ea
42339	Right Mount Bracket with Scraper for 2100 /1200 (2002 & Newer)	\$ 45 ea
42397	Poly Scraper Only - 2100 /1200 (2002 & Newer)	\$ 21 ea
42336	Left Mount Bracket with Scraper for 1200 (2001 & Older) /955 /900 /800	\$ 45 ea
42337	Right Mount Bracket with Scraper for 1200 (2001 & Older) /955 /900 /800	\$ 45 ea
42341	Poly Scraper Only - 1200 (2001 & Older) /955 /900 /800	\$ 21 ea
FOR CASE IH PRESS WHEELS		
PART NO	DESCRIPTION	RETAIL PRICE
83693	Press Wheel Scraper Kit for 800-1200	\$ 85 ea
85033	Press Wheel Scraper Kit for 2100	\$ 85 ea
42343	Poly Scraper Only	\$ 21 ea

FOR JOHN DEERE /KINZE GAUGE WHEELS		
PART NO	DESCRIPTION	RETAIL PRICE
83696	Mount Bracket with Scraper Covers one side, two required per row. Welding required.	\$ 45 ea
42347	Poly Scraper Only	\$ 15 ea
FOR JOHN DEERE /KINZE PRESS WHEELS		
PART NO	DESCRIPTION	RETAIL PRICE
83697	Mount Bracket with Scraper Covers two sides, one required per row.	\$ 56 ea
83698	Mount Bracket with Scraper for John Deere 455 Drills One required per row.	\$ 75 ea
FOR GREAT PLAINS PRESS WHEELS		
PART NO	DESCRIPTION	RETAIL PRICE
83694	Mount Bracket with Scraper One required per row.	\$ 75 ea
FOR WHITE GAUGE WHEELS		
PART NO	DESCRIPTION	RETAIL PRICE
83699	Mount Bracket with Scraper Covers one side, two required per row. Welding required.	\$ 60 ea



REBOUNDER™ SEED COVERS & Y-NOT SPLIT-IT™

The Rebounder™ Seed Cover is a simple and effective planting attachment that improves accuracy of seed placement and uniformity.

- Patented Convex Design
 - Durable, Flexible & Non-Stick
 - Resists Corrosion from Fertilizer Applications
- Scan the QR code to learn more.

SCAN ME



SUPER TUFF REBOUNDER™ FURROW COMPARISON

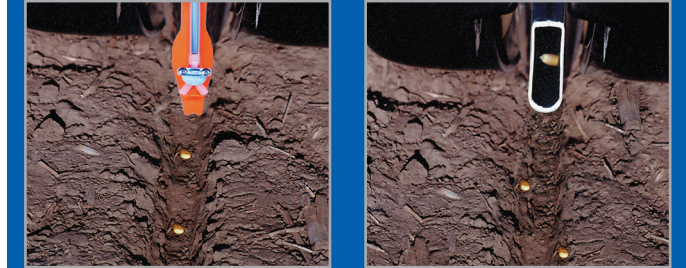

WITH Rebounder™

Without Rebounder™

IMPROVE THE ACCURACY OF SEED PLACEMENT = STRONGER ROOT BASE

SUPER-TUFF ORANGE REBOUNDER™

PLANTERS (Per Row, Mount Brackets sold separately)

FOR CASE IH		
PART NO	DESCRIPTION	RETAIL PRICE
82354	FOR Case IH 800 /900 /950 /955	\$ 45 ea
82358	FOR Case IH 1200 (2008 & Older) *	\$ 35 ea
83196	FOR Case IH Mount Bracket (2008 & Older)	\$ 18 ea
83197	FOR Case IH 1200 (2009 & Newer)	\$ 35 ea
82470	FOR Case IH Seed Boot Bracket (2009 & Newer)	\$ 21 ea
FOR JOHN DEERE		
PART NO	DESCRIPTION	RETAIL PRICE
83646	FOR John Deere ExactEmerge *	\$ 35 ea
83647	FOR John Deere ExactEmerge Mount Bracket	\$ 27 ea
82351	FOR John Deere 7000 /7200 /7300 & 1700 Series	\$ 35 ea
FOR MISC.		
PART NO	DESCRIPTION	RETAIL PRICE
82353	FOR Kinze	\$ 35 ea
83570	FOR Kinze with EdgeVac *	\$ 35 ea
83571	FOR Kinze with EdgeVac Mount Bracket	\$ 15 ea
82355	FOR Monosem	\$ 35 ea
82356	FOR Yetter	\$ 35 ea
83552	FOR Clearshot Seed Tube	\$ 35 ea

FOR MISC.		
PART NO	DESCRIPTION	RETAIL PRICE
82357	FOR Great Plains Heavy Duty Series Drills 3000 /4000 (No Bracket Required)	\$ 35 ea
82363	FOR Great Plains Precision Drills *	\$ 35 ea
82164	FOR Great Plains Precision Drills Mount Bracket	\$ 15 ea
82367	FOR Great Plains Series Solid Stand 00/10/20 & 1510 Openers *	\$ 35 ea
82165	FOR Great Plains Series Solid Stand 00/10/20 & 1510 Openers Mount Bracket	\$ 15 ea
82440	FOR Krause No-Till Drills 5200 /5250 /5500 *	\$ 47 ea
82166	FOR Krause No-Till Drills 5200 /5250 /5500 Mount Bracket	\$ 13 ea
82366	FOR Tye No-Till Drills *	\$ 35 ea
82463	FOR Tye No-Till Drills Mount Bracket	\$ 15 ea
82368	FOR Krause 5400 No-Till Drill *	\$ 35 ea
82167	FOR Krause 5400 No-Till Drill Mount Bracket	\$ 15 ea
83683	FOR Salford Drill *	\$ 35 ea
83684	FOR Salford Drill Mount Bracket	\$ 15 ea

DRILLS (Per Row, Mount Brackets sold separately)

FOR CASE IH		
PART NO	DESCRIPTION	RETAIL PRICE
83555	FOR Case IH Drills 5100 /5300 /5400 /5500 *	\$ 35 ea
83556	FOR Case IH Drills 5100 /5300 /5400 /5500 Mount Bracket	\$ 18 ea
FOR JOHN DEERE		
PART NO	DESCRIPTION	RETAIL PRICE
82359	FOR John Deere No-Till Drills 750 /1560 /1590 /1690 /1850 /1860 /1890 /1990 *	\$ 15 ea
82361	FOR John Deere No-Till Drills 450 /455 /515 /520 /1520 /8300 *	\$ 35 ea
82162	FOR John Deere No-Till Drills 450 /455 /515 /520 /1520 /8300 Mount Bracket	\$ 15 ea
83557	FOR John Deere Drill Stop for Drills 1550-1990	\$ 15 ea

FOR MISC.		
PART NO	DESCRIPTION	RETAIL PRICE
82362	FOR Sunflower No-Till Drills *	\$ 35 ea
82163	FOR Sunflower No-Till Drills Mount Bracket	\$ 15 ea

SUPER-TUFF ORANGE REBOUNDER™

DRILLS (Per Row, Mount Brackets sold separately) continued...

FOR MISC.		
PART NO	DESCRIPTION	RETAIL PRICE
82168	Y-Not Split-It™ FOR Case IH 800 /900 /950 /955 Includes: Y, 1/4" Hose (30" Long), 3/8" Hose (4" Long), Tube Clamp, Tie Strap, Screws, Metal Plate	\$ 15 ea
82168	Y-Not Split-It™ FOR Case IH 1200 Includes: Y, 1/4" Hose (30" Long), 3/8" Hose (4" Long), Tie Strap, Screws, Metal Plate	\$ 15 ea
82389	Y-Not Split-It™ FOR John Deere, Kinze, White, Yetter, Great Plains, & Monosem Includes: T-Nut, 1/4" Hose (30" Long), L Bracket, Washer, Slotted Screw, Y-Not Split-It, 3/8" Tube (4" Long), Metal Plate	\$ 15 ea
82390	Hose Holder FOR John Deere, Kinze, White, Yetter, Great Plains, & Monosem Includes: T-nut, 1/4" Hose (30" Long), L Bracket, Washer, Slotted Screw, Metal Plate	\$ 9 ea
82984	Y-Not Split-It™ FOR Drills Includes: Y, 1/4" Hose (30" Long), 3/8" Hose (4" Long), Tie Strap, Screws, Metal Plate	\$ 10 ea

*Requires mount bracket if purchasing for the first time

FERTILIZER TUBES

PART NO	DESCRIPTION	RETAIL PRICE
82391	Y-Not Split-It™ FOR Case IH 800 /900 /950 /955 Includes: Y, 1/4" Hose (30" Long), 3/8" Hose (4" Long), Tube Clamp, Tie Strap, Screws, Metal Plate	\$ 15 ea
82168	Y-Not Split-It™ FOR Case IH 1200 Includes: Y, 1/4" Hose (30" Long), 3/8" Hose (4" Long), Tie Strap, Screws, Metal Plate	\$ 15 ea
82389	Y-Not Split-It™ FOR John Deere, Kinze, White, Yetter, Great Plains, & Monosem Includes: T-Nut, 1/4" Hose (30" Long), L Bracket, Washer, Slotted Screw, Y-Not Split-It, 3/8" Tube (4" Long), Metal Plate	\$ 15 ea
82390	Hose Holder FOR John Deere, Kinze, White, Yetter, Great Plains, & Monosem Includes: T-nut, 1/4" Hose (30" Long), L Bracket, Washer, Slotted Screw, Metal Plate	\$ 9 ea
82984	Y-Not Split-It™ FOR Drills Includes: Y, 1/4" Hose (30" Long), 3/8" Hose (4" Long), Tie Strap, Screws, Metal Plate	\$ 10 ea

CLOSING WHEELS

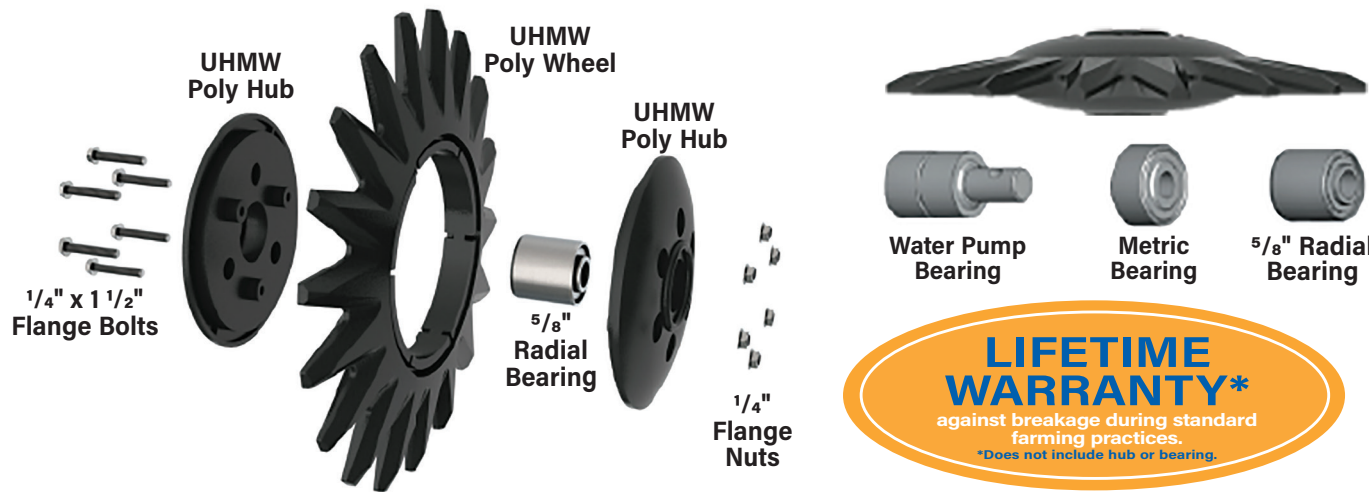

LIFETIME WARRANTY*
 against breakage during standard farming practices.
*Does not include hub or bearing.

MAY WES POLY CLOSING WHEELS LAST LONGER & WEAR BETTER

TOUGH. Eliminates Breakage **DURABLE.** Absorbs Impact & Prevents Corrosion
SLICK. Reduces Build-Up & Drag **OUTPERFORMS.** Replacement for Factory Closing Wheels



Star Wheels

About Star Wheels:

- Crumbles Compacted Soil
- Applications for Planter Closing Wheel & Row Cleaner



G2 STAR WHEEL

- Improved Design
- Shorter Points
- Catch Less Debris
- 13 1/2" Outside Diameter



Compaction causes poor root base and slows emergence



May Wes Closing Wheels close the seed furrow without compaction

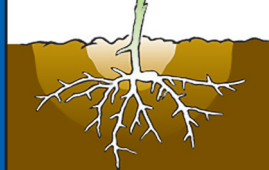

STAR CLOSING WHEELS - 12"

PART NO	DESCRIPTION	RETAIL PRICE
81841	FOR John Deere 7000 /7100 Series, Kinze 2000 Series, Great Plains 2020 /3020 (Waterpump Bearing)	\$ 227 pr
81870	FOR John Deere 7200 /7300 Series, MaxEmerge 2 (Metric Bearing)	\$ 227 pr
82472	FOR John Deere 1700 Series MaxEmerge Plus /XP, Kinze 3000 Series*, White, Newer Great Plains (5/8" Bearing)	\$ 227 pr

*Kinze 1993 & Later use 5/8" Bearing

STAR CLOSING WHEELS - 13 1/2"

PART NO	DESCRIPTION	RETAIL PRICE
83888	G2 Star Closing Wheel - Star Only Fits most OEM wheels, including John Deere 1700 MaxEmerge Plus, XP, XP Pro, Kinze 1993 & Newer, Great Plains, AGCO, White Reuse OEM hub and hardware	\$ 136 pr

DRILL / AIR SEEDER

PART NO	DESCRIPTION	RETAIL PRICE
40706	Star for John Deere 750 Air Drill Kit (Metric)	\$ 114 ea
40991	Star for John Deere 1560 /1565 /1590 Grain Drills 1690 /1860 /1890 /1895 /1990 Air Drills	\$ 114 ea

WHEEL KITS

PART NO	DESCRIPTION	RETAIL PRICE
40666	12" Star Kit (Waterpump Bearing)	\$ 114 ea
40706	12" Star Kit (Metric Bearing)	\$ 114 ea
41490	12" Star Kit (5/8" Radial Bearing)	\$ 114 ea

Kits include Wheel, Bearing & Hardware.

CLOSING WHEELS

HUB KITS (Kits Include Hub, Bearing & Hardware)

PART NO	DESCRIPTION	RETAIL PRICE
40752	Waterpump Hub Kit	\$ 73 ea
40753	Metric Hub Kit	\$ 87 ea
41496	5/8" Radial Hub Kit	\$ 88 ea

WHEELS

PART NO	DESCRIPTION	RETAIL PRICE
20874	12" Star Wheel	\$ 62 ea

HUBS (2 Hubs Required Per Wheel)

PART NO	DESCRIPTION	RETAIL PRICE
40738	Waterpump Hub	\$ 25 ea
40874	Metric Hub	\$ 25 ea
41493	5/8" Radial Bearing Hub	\$ 25 ea

BEARINGS

PART NO	DESCRIPTION	RETAIL PRICE
20869	Waterpump Bearing (5/8")	\$ 25 ea
40728	Metric Bearing (17mm - 11/16")	\$ 46 ea
22072	* 5/8" Radial Bearing (5/8")	\$ 32 ea

*Kinze 1993 & Later use 5/8" Bearing

SPACER BUSHINGS

PART NO	DESCRIPTION	RETAIL PRICE
22073	Spacer Bushing: 5/8" Inner Diameter, 3/8" Length Used with 5/8" Bearing & Hub	\$ 8 ea
20989	Spacer Bushing: 5/8" Inner Diameter, 5/8" Length Used with 17mm - 11/16" Bearing	\$ 7 ea

NUTS & BOLTS

PART NO	DESCRIPTION	RETAIL PRICE
00915	Flange Bolt (6 Per Wheel, 12 Per Row)	\$ 0.50 ea
00917	Flange Nut (6 Per Wheel, 12 Per Row)	\$ 0.25 ea
00197	5/8" Nut	\$ 1.50 ea
00018	5/8" x 3 1/8" Bolt	\$ 2.00 ea

Key Material Features of UHMW:

- UHMW is exceedingly strong and durable.
- UHMW Wheels/Fingers deflect when encountering objects, but will return to their original molded position (shape memory).
- UHMW does not corrode like steel and stays cleaner due to the non-stick poly surface.

PLANTER BOX TOPPERS & HINGES



ONE PIECE DESIGN

- Fits 1.6 Bushel Planter Boxes Only
- Adds 1 Bushel Capacity
- Watertight Fit Prevents Seed Loss During Transport
- Use Original Lid - Fits Tight Preventing Lid Loss

Planter Box Hinges

Attach directly to your existing planter box and lid to secure lid to the box.

PART NO 82717 \$ 13.50 ea

POLY SEED BOX EXTENSION - SNAP ON

PART NO	DESCRIPTION	RETAIL PRICE
82658	FOR John Deere 7200 /7300 /1760 /1780 MaxEmerge 2 Row Unit /1700 /1710 /1720 /1730 /1750 /1760 /1780 1770 /MaxEmerge Plus /XP Row Units - Yellow	\$ 44.27 ea
82659	FOR Kinze 3000 Series ('01 & Newer) - White	\$ 44.27 ea

FIBERGLASS SEED BOX EXTENSION - BOLT ON

PART NO	DESCRIPTION	RETAIL PRICE
82536	FOR Case IH 1200 - Gray	\$ 179 ea
82531	FOR John Deere 7000 & 7100 - Yellow	\$ 109 ea
82532	FOR John Deere 7200 & 7300 (thru 1992) - Yellow	\$ 109 ea
82534	FOR Kinze 2000 - White	\$ 109 ea

FERTILIZER BOX TOPPERS



PLANT LONGER, GET DONE FASTER.

- Adds up to 400 lbs. per Hopper
- Easy Installation - Use Original Lid
- Durable Fiberglass Construction with Steel Cross Brace

PART NO	DESCRIPTION	RETAIL PRICE
82539	FOR John Deere - All Models	\$ 279 ea
82540	FOR Kinze - All Models	\$ 279 ea

SEED FILL TUBES - TELESCOPING

DISTRIBUTE SEED FASTER

Telescoping Seed Fill Tubes extend and retract to give you the flexibility you need to distribute seed easier, faster and with less spillage. Take control of the tube direction with the built-in handle and sturdy construction of the seed fill tube.



All telescoping tubes include flex hose, clamp & handle.

2 & 3 STAGE TELESCOPING SEED FILL TUBE WITH HANDLE

6" AUGERS (Includes 16" of Flex Hose)			
PART NO	DESCRIPTION	SIZE	RETAIL PRICE
83530	2 Stage	4' - 7' L	\$ 140 ea
82718	3 Stage	4' - 10' L	\$ 180 ea
82719	3 Stage	5' - 13' L	\$ 190 ea
82720	3 Stage	6' - 16' L	\$ 200 ea
82721	3 Stage	7' - 19' L	\$ 220 ea

7" AUGERS (Includes 18" of Flex Hose)			
PART NO	DESCRIPTION	SIZE	RETAIL PRICE
83531	2 Stage	4' - 7' L	\$ 150 ea
83532	2 Stage	6' - 11' L	\$ 170 ea
83533	3 Stage	4' - 10' L	\$ 190 ea
83534	3 Stage	5' - 13' L	\$ 200 ea
83006	3 Stage	6' - 16' L	\$ 220 ea

8" AUGERS (Includes 20" of Flex Hose)			
PART NO	DESCRIPTION	SIZE	RETAIL PRICE
83535	2 Stage	4' - 7' L	\$ 160 ea
83536	2 Stage	6' - 11' L	\$ 180 ea
83537	3 Stage	4' - 10' L	\$ 200 ea
83007	3 Stage	6' - 16' L	\$ 230 ea

10" AUGERS (Includes 24" of Flex Hose)			
PART NO	DESCRIPTION	SIZE	RETAIL PRICE
83652	2 Stage	6' - 11' L	\$ 350 ea

REPLACEMENT URETHANE FLEX HOSE			
PART NO	DESCRIPTION	SIZE	RETAIL PRICE
42259	Flex Hose	6" I.D.	\$ 21 ft
42260	Flex Hose	7" I.D.	\$ 24 ft
42261	Flex Hose	8" I.D.	\$ 27 ft
42262	Flex Hose	10" I.D.	\$ 35 ft

SEED FILL TUBES - NON-TELESCOPING

Bulk Seed Fill Tubes are perfect for bulk fill applications where extended telescoping lengths are not required. They are compact yet flexible to allow easy positioning of the tube. These one-piece tubes make loading your bulk fill planter easy.



NON-TELESCOPING BULK SEED FILL TUBE WITH HANDLE

Available in 4 Ft. Length & Auger Diameters of 6", 7" & 8"

All non-telescoping tubes include flex hose, clamp & handle.

PART NO	DESCRIPTION	SIZE	RETAIL PRICE
83009	6" Auger Includes 16" of Flex Hose	4' L	\$ 90 ea
83010	7" Auger Includes 18" of Flex Hose	4' L	\$ 95 ea
83011	8" Auger Includes 20" of Flex Hose	4' L	\$ 100 ea

POLY CUPPED & STRAIGHT AUGER FLIGHTING

All Right Hand Flighting Only

THE PROVEN CHOICE FOR BULK GRAIN SEED HANDLING

5" - 6" - 7" - 9" POLY CUPPED AUGERS FOR:

- SEED TENDERS
- GRAVITY BOX AUGERS
- TRUCK MOUNT TAILGATE AUGERS
- AIR SEED FILL AUGERS
- TRANSPORT AUGERS
- BIN UNLOAD AUGERS



Poly Cupped Auger Flighting

Protecting your grain and seed from auger handling and damage is a no-brainer. University testing has proven Poly Cupped Flighting to have **5-times lower soybean seed cracking** as compared to factory steel (reference chart below). Poly Cupped Flighting is ideal for gentle handling of bulk grain and seeds, such as soybeans, popcorn, edible peas, lentils and white corn.

Poly Straight Auger Flighting

Provides an economical way to replace your outdated steel auger and upgrade to the industry best! Perfect for tough jobs of transferring fertilizer and corrosive materials. The High Density Polyethylene (HDPE) material is also safe for food handling.

Soybean Crack Test Results

Flighting Type	Percent Breakage	Average Breakage
Plastic Cup	0.38 %	38
Bristle	0.35 %	35
Steel	1.80%	180
Steel Cup	2.10%	210

Average breakage based on per 10,000 beans. Test ran with hydraulic motor at 12 gal/min (6" x 13' uni-swivel auger at a 45° angle). Average moisture content of the bean seed sample was 12%. Reprinted with permission from J&M Manufacturing Co.

COMPLETE CUPPED FLIGHTING KITS

FOR TRUCK AUGERS		
PART NO	DESCRIPTION	RETAIL PRICE
82985	Westfield DF 614 Truck Mount Drill Fill	\$ 466 ea

FOR GRAVITY BOX AUGERS - 5" DIAMETER		
PART NO	DESCRIPTION	RETAIL PRICE
82986	Parker 11'	\$ 315 ea
82987	Killbros 12'	\$ 316 ea
82988	Killbros 14'	\$ 368 ea
83539	Killbros 15'	\$ 396 ea
83540	MJM 14'	\$ 403 ea
83541	EZ-Trail 12'	\$ 359 ea
83542	EZ-Trail 14'	\$ 410 ea
83543	Sudenga 14'	\$ 401 ea
83544	Hydrafold 14'	\$ 379 ea
83545	Hydrafold 16'	\$ 437 ea
83546	Ficklin /Shoup 12'	\$ 303 ea
83547	Ficklin /Shoup 14'	\$ 356 ea
83548	Ficklin /Shoup 16'	\$ 408 ea
82989	Westfield GWA612	\$ 346 ea
82990	Westfield GWA615	\$ 424 ea
82991	J&M 13'	\$ 336 ea
82992	J&M 15'	\$ 387 ea

FOR WEIGH WAGONS - 7-8" DIAMETER		
PART NO	DESCRIPTION	RETAIL PRICE
82993	Parkan GW 150	\$ 592 ea
82994	Parkan GW 200 - with 9 1/2' top auger	\$ 667 ea
82995	Parkan GW 200 - with 11' top auger	\$ 710 ea
82996	Brent 150	\$ 782 ea
82997	Unverferth 150	\$ 767 ea
83549	Parker 1500/1550	\$ 580 ea
83550	Parker 1555 - 7 3/4" diameter	\$ 671 ea

FOR AIR SEEDER CARTS - 7" DIAMETER AUGER TUBE

PART NO	DESCRIPTION	RETAIL PRICE
83707	John Deere 1910-21' Stainless Steel Shaft	\$ 911 ea

FOR AIR SEEDER CARTS - 8" DIAMETER AUGER TUBE

PART NO	DESCRIPTION	RETAIL PRICE
82998	John Deere 1910-21' Galvanized Steel Shaft	\$ 692 ea
82999	John Deere 1910-21' Stainless Steel Shaft	\$ 910 ea
83000	John Deere 1910-23' Galvanized Steel Shaft	\$ 750 ea
83001	John Deere 1910-23' Stainless Steel Shaft	\$ 990 ea
83002	John Deere 787 /Flexicoil 20 Series Galvanized Steel Shaft	\$ 482 ea
83008	John Deere 787 /Flexicoil 20 Series Stainless Steel Shaft	\$ 608 ea

Note: Due to large size, additional shipping fee may apply. Kits may ship in sections to reduce shipping cost. Contact May Wes for a shipping estimate.

QUESTIONS?

Watch our FAQ video.

Scan the code with your smartphone to watch on YouTube.





STOP SCRATCHING YOUR ASPHALT! INSTALL A MAY WES POLY CUTTING EDGE

VERTICAL POLY CUTTING EDGE FOR SNOW PUSHERS AND PLOWS

Unbeveled · Optional Straight Holes



VERTICAL POLY CUTTING EDGES		
PART NO	DESCRIPTION	RETAIL PRICE
83873	6" Wide x 1" Thick - Per Running Inch	\$ 3.50 in
83874	6" Wide x 1 1/2" Thick - Per Running Inch	\$ 5.00 in
83875	8" Wide x 1" Thick - Per Running Inch	\$ 4.55 in
83876	8" Wide x 1 1/2" Thick - Per Running Inch	\$ 6.30 in
83877	Drilling of each hole	\$ 4.35 ea
81724	2" Hardware Kit Includes: 5/8" x 2" Mounting Bolt, Nut, Lock Washer & Washer (One kit required per hole)	\$ 5.90 ea
83686	3" Hardware Kit Includes: 5/8" x 3" Mounting Bolt, Nut, Lock Washer & Washer (One kit required per hole)	\$ 5.90 ea

*Recommend 3" Hardware Kits for thicker blades.

All per running inch options are undrilled.
All orders are subject to a \$100 minimum per cutting edge.

SNOW PUSHER SKID SHOES		
PART NO	DESCRIPTION	RETAIL PRICE
83946	8" Wide x 1 1/2" Thick - Per Running Inch	\$ 6.30 in
84028	Drilling of Slotted Holes - Per Running Inch	\$ 6.00 in
83686	3" Hardware Kit Includes: 5/8" x 3" Mounting Bolt, Nut, Lock Washer & Washer (One kit required per hole)	\$ 5.90 ea

*Recommend 3" Hardware Kits for thicker blades.



Featured by Fast Ag Montana, Larson Farms, Stanley the Dirt Monkey & Finstad Skidloader Service

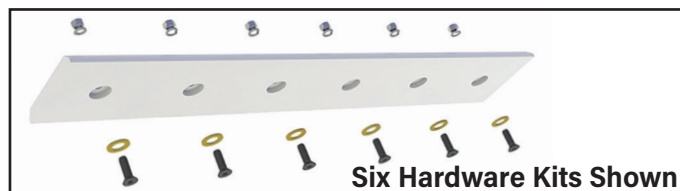

HOW TO ORDER

VERTICAL OR HORIZONTAL CUTTING EDGE

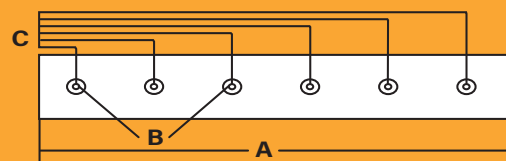

Information to know before calling

- A. Cutting Edge Length _____
- B. Quantity of holes _____
- C. Distance from edge to center of each hole _____

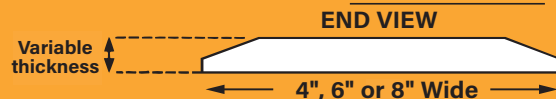

No Returns Accepted on Custom Orders

SLICK AND DURABLE UHMW POLY PROTECTS PAVEMENT FROM PLOW DAMAGE

HORIZONTAL POLY CUTTING EDGE FOR BUCKETS AND SKID LOADERS

Beveled on Both Sides · Optional Counterbored Holes



PROTECT PAVEMENT FROM EQUIPMENT DAMAGE

- Designed to Protect Smooth, Hard Surfaces such as cobblestone and some pavements that can be damaged by equipment. Not designed for continual use on rough surfaces.
- Non-Stick UHMW Poly Surface Reduces Debris Build-Up
- Prevents Scuffing Concrete or Cobblestone Sidewalks
- Less Shock to Equipment in Uneven Concrete Conditions
- Lightweight Compared to Metal Cutting Edges
- Simple Installation & Maintenance-Free Operation

HORIZONTAL POLY CUTTING EDGES		
PART NO	DESCRIPTION	RETAIL PRICE
81732	8" Wide x 3/4" Thick - Per Running Inch	\$ 3.55 in
81733	8" Wide x 1" Thick - Per Running Inch	\$ 4.55 in
82126	8" Wide x 1 1/2" Thick - Per Running Inch	\$ 6.30 in
83518	6" Wide x 3/4" Thick - Per Running Inch	\$ 2.85 in
83519	6" Wide x 1" Thick - Per Running Inch	\$ 3.50 in
83520	6" Wide x 1 1/2" Thick - Per Running Inch	\$ 5.00 in
82133	4" Wide x 3/4" Thick - Per Running Inch	\$ 2.25 in
83521	4" Wide x 1" Thick - Per Running Inch	\$ 2.60 in
83522	4" Wide x 1 1/2" Thick - Per Running Inch	\$ 3.70 in
81734	Drilling of Each Counterbored Hole	\$ 4.85 ea
81724	2" Hardware Kit Includes: 5/8" x 2" Mounting Bolt, Nut, Lock Washer & Washer (One kit required per hole)	\$ 5.90 ea
83686	3" Hardware Kit Includes: 5/8" x 3" Mounting Bolt, Nut, Lock Washer & Washer (One kit required per hole)	\$ 5.90 ea

*Recommend 3" Hardware Kits for thicker blades.

All per running inch options are undrilled.
All orders are subject to a \$100 minimum per cutting edge.

INSTALLATION VIDEOS

Tony Fast reviews his 3-year-old Poly Cutting Edge

Installing a Poly Cutting Edge at Larson Farms

Stanley "Dirt Monkey" Genadek's Arctic LD Sectional Snow Pusher

Stanley "Dirt Monkey" Genadek's Boss Drag Pro 180Z

Scan the QR codes with your smartphone to watch on YouTube.

QUESTIONS?

Watch our FAQ video on YouTube.



SHOW US YOUR POLY CUTTING EDGE IN ACTION!

Tag May Wes Manufacturing on social media for a chance to be featured.





SKID HITCH

NEW

LIGHTWEIGHT · QUICKLY INSTALL & REMOVE

The **Skid Hitch** allows you to quickly add a standard 2" trailer hitch receiver (not included) to your skid loader.

- Compatible with any make or model of skid loader
- Lightweight and easy to install and remove
- Portable, fits right in your truck toolbox
- **1,000 lb tongue weight rating**

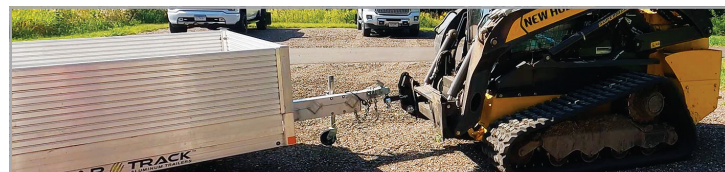

SKID HITCH		
PART NO	DESCRIPTION	RETAIL PRICE
83884	Skid Hitch	\$ 195 ea

QUESTIONS?
Watch our FAQ video.

SCAN ME

Scan the QR code with your smartphone to watch on YouTube.



FEATURED BY
Stanley "Dirt Monkey"
Genadek

LOCK N LUBE® & LOCK N FLATE®

NEW

THE NEW STANDARD IN GREASE GUNS AND LOCKING AIR CHUCKS

LOCKNLUBE®

- The World's First Leak-Free Grease Guns
- LockNLube® Grease Coupler
- **Locks On - Stays On - Doesn't Leak**
- Open up clogged fittings with the Grease Buster®

LOCKNFLATE®

- Six steel jaws to lock onto any Schrader valve for a **secure, hands-free connection**
- Closed flow or open flow applications
- Heavy-duty construction

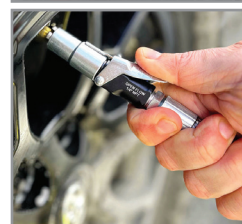

LOCKNLUBE® GREASE GUNS		
PART NO	DESCRIPTION	RETAIL PRICE
84417	LOCKNLUBE® Heavy-Duty Lever Grip Grease Gun	\$ 69.99 ea
84418	LOCKNLUBE® Heavy-Duty Pistol Grip Grease Gun	\$ 69.99 ea

OPTIONAL ACCESSORIES		
PART NO	DESCRIPTION	RETAIL PRICE
84420	8-Piece LOCKNLUBE® Quick Connect Greasing Accessory Kit Eight quick-connect adapters for easy access to hard-to-reach grease fittings. Includes: 90° Grease Coupler, Push-On 90° Grease Coupler, Narrow Needle Nose Dispenser, Grease Injector Needle, Quick-Connect Grease Hose Adapter, Seal-Off Grease Adapter, Recessed Fitting Adapter, Simple 90° Adapter	\$ 79.99 ea
84410	LOCKNLUBE® Grease Gun Coupler with Spare Rebuild Kit	\$ 32.99 ea
84411	LOCKNLUBE® Grease Gun Coupler XL - Extra Reach for Recessed Fittings	\$ 41.99 ea
84419	The Original Grease Buster® - Clear Out Clogged Grease Fittings	\$ 54.99 ea

LOCKNFLATE®		
PART NO	DESCRIPTION	RETAIL PRICE
84413	LOCKNFLATE® Locking Air Chuck - Open Flow	\$ 39.99 ea
84414	LOCKNFLATE® Locking Air Chuck - Closed Flow	\$ 39.99 ea
84415	LOCKNFLATE® Locking Dual Wheel Adapter - 15 1/2" Extended Reach	\$ 99.99 ea



AIR FILTER BLASTER



EXTEND THE LIFE OF YOUR FILTERS

- Reduces fuel consumption
- Increases the life of your equipment
- Increases engine performance

Safe For Filters

The distribution of air allows a maximum of 48 psi to come out of any one air jacket in the Filter Blaster. Testing has proven the filters can withstand many Air Filter Blaster uses.

Saves You Money

Reduces filter replacement costs and landfill charges, which improves your bottom line.



COMPLETE KIT		
PART NO	DESCRIPTION	RETAIL PRICE
83685	Air Filter Blaster with 6" Rotor	\$ 299 kit

OPTIONAL ACCESSORIES		
PART NO	DESCRIPTION	RETAIL PRICE
42311	3" Rotor Head for filters with 3" - 4 1/2" inside diameter	\$ 59 ea
42312	4 1/2" Rotor Head for filters with 4 1/2" - 6" inside diameter	\$ 59 ea
42313	6" Rotor Head for filters with 6" - 9" inside diameter	\$ 59 ea
42314	9" Rotor Head for filters with inside diameter over 9"	\$ 59 ea
42315	12" Extended Shaft (includes O-ring) for filters with depths above 26"	\$ 59 ea

Designed to be taken directly into the field, requires only 90 psi to operate. Standard 6" Rotor Head included. Minimum of 90 PSI to Maximum of 135 PSI for use.

PRODUCT VIDEO
Watch the MN Millennial Farmer test out the Air Filter Blaster!

SCAN ME

Featuring
Minnesota
Millennial
Farmer

RIDE TAMER ZERO-TURN SUSPENSION SYSTEM

NEW

ENJOY A 47% SMOOTHER RIDE!

Patented Torsion Suspension & Trailing Arm Design
Ideal for large properties and commercial lawn services.
Reduces stress to your mower's frame and your back!



FOR JOHN DEERE			
PART NO	SERIES	MODEL	RETAIL PRICE
84060	Z-Series	Z930A, Z930M, Z930M-EFI, Z930R, Z945M, Z945M-EFI, Z950A, Z950M, Z950R, Z955M, Z955M-EFI, Z955R	\$ 649 kit

FOR TORO			
PART NO	SERIES	MODEL	RETAIL PRICE
84061	Timecutter, Battery Timecutter	75734, 75740, 75742, 75746, 75747, Battery Timecutter 42"/54" Deck	\$ 649 kit
84062	Timecutter, Grandstand Revolution Series	75750, 75755, 75754, 75760, Grandstand Revolution 48"/52"/60" Deck	\$ 649 kit

FOR SCAG			
PART NO	SERIES	MODEL	RETAIL PRICE
84061	Z-Cat, Liberty Z	SCZ-36A, SCZ-42A, SZL-36H, SZL-42H, SZL-48H	\$ 649 kit
84062	Tiger Cub, STZ, SSZ, SVRII Stand On, Wildcat, Tigercat, Turf Tiger, Liberty Z, Freedom Z, Patriot, Tiger Cat II	STC-48, STC-61, STZ-20KH-52, SSZ-18CV-48, SSZ-22CV-61, SVRII-32A, SVRII-36A, SVRII-48A, SVRII-61A, SVRXL-48A, SVRXL-61A, STWC-48, STWC-52, STC-48, STC-52, STT-52, SZL-52H, SZL-61H, SFZ-48H, SFZ-52H, SPZ-52H, SPZ-61H, STCII-48V, STCII-52V, STCII-61V	\$ 649 kit
84063	Wildcat, Tigercat, Turf Tiger, Cheetah, Cheetah II, Turf Tiger II	STWC-61, STC-61, STT-61, SCZ-61, SCZII-61V, STTII-52V, STTII-61V	\$ 649 kit
84064	Turf Tiger, Cheetah, Sabre Tooth Tiger, Cheetah II, Turf Tiger II	STT-72, SCV-72, STT-SG-61, STT-SG-72, STT-BSD-61, STT-BSD-72, SCZII-72V, STTII-72V	\$ 649 kit



SLICKPLATE™ BY MINIMIZER™



No Grease or Mess. Saves Time and Money.

BENEFITS INCLUDE:

- Non-stick Poly Surface
- Eliminates Need to Grease
- Prolong Your Fifth Wheel Life
- Debris Will Not Stick
- Less Friction
- For Easier Handling
- Basic Installation
- All Hardware Included

As featured by **Fast Ag Montana**



POLY COVERS ALL CRITICAL WEAR AREAS

PLEASE MEASURE THESE DISTANCES BEFORE CALLING.

DIMENSIONS TO THE RIGHT ARE APPROXIMATE AND APPLY TO THE POLY COVER, NOT YOUR METAL PLATE.

REPLACEMENT PARTS

PART NO	DESCRIPTION	RETAIL PRICE
102789	Hardware Kit - FW35 Only (Ram Bars Not Included)	\$ 37 ea
100062	Hardware Kit (Ram Bars Not Included)	\$ 37 ea
100084	2 1/2" Ram Bar Kit	\$ 47 ea
100075	3 1/2" Ram Bar Kit	\$ 47 ea
100068	5 3/4" Ram Bar Kit	\$ 47 ea
100063	7 1/4" Ram Bar Kit	\$ 47 ea

SLICKPLATE™ FOR HOLLAND®

Model:	FW35	FW17	FW8	FW3500 / FW2535	FWS1	FW6000
Height:	32 1/2"	26 1/2"	29"	32 1/2"	25 1/2"	25"
Width:	34 1/2"	35 1/2"	35 1/2"	37"	36"	20 1/2"
PART NO	100061	100067	100070	100065	100072	100074
RETAIL PRICE	\$ 265 ea	\$ 265 ea	\$ 265 ea	\$ 265 ea	\$ 265 ea	\$ 265 ea

SLICKPLATE™ FOR FONTAINE®

Model:	7000	6000 (No Slack II)	5092	3000	CASTLOC	CASTLOC II
Height:	30"	30"	32"	26 1/2"	33"	36 1/2"
Width:	35"	35"	35 1/2"	35"	36"	36 1/2"
PART NO	100077	100079	100081	100083	100096	100098
RETAIL PRICE	\$ 265 ea	\$ 265 ea	\$ 265 ea	\$ 265 ea	\$ 265 ea	\$ 265 ea

SLICKPLATE™ FOR ASF®

SLICKPLATE™ FOR JOST®

Model:	JSK37H Series	JSK37F Series	JSK37U / JSK37USL	Simplex SE	Simplex II	Simplex Lite
Height:	31 1/2"	30"	30"	25 1/2"	33"	26 1/2"
Width:	35"	35 1/2"	35 1/2"	36"	36"	35 1/2"
PART NO	100088	100086	103090	100090	100094	100092
RETAIL PRICE	\$ 265 ea	\$ 265 ea	\$ 265 ea	\$ 265 ea	\$ 265 ea	\$ 265 ea

SLICKPLATE™ FOR SIMPLEX®

SLICKPLATE™ FOR REESE®

Model:	18K, 20K & 25K	15K	Fits Most Models
Height:	15 1/2"	14"	15"
Width:	19"	11 1/2"	11 1/2"
PART NO	100100	100164	100165
RETAIL PRICE	\$ 265 ea	\$ 228 ea	\$ 228 ea

SLICKPLATE™ FOR ROBIN INDUSTRIES®

SLICKPLATE™ FOR RV FIFTH WHEEL

Dimensions are approximate and apply to the poly cover, not your metal plate. Must continue to grease king pin. Illustrations above not shown to scale. Hardware & Ram Bars included with all kits.

As Featured by **MN Millennial Farmer, Fast Ag Montana & Larson Farms**



Made in the U.S.A.

HOLLAND® is a registered trademark of SAF-Holland, Inc., with which neither Pride Solutions LLC nor May Wes Manufacturing has an affiliation. Fontaine® is a registered trademark of Fontaine International, Inc., with which neither Pride Solutions LLC nor May Wes Manufacturing has an affiliation. Reese® is a registered trademark of Horizon Global Corporation, with which neither Pride Solutions LLC nor May Wes Manufacturing has an affiliation. Robin Industries® is a registered trademark of Robin Industries, Inc., with which neither Pride Solutions LLC nor May Wes Manufacturing has an affiliation. SIMPLEX®, SIMPLEX SE®, SIMPLEX II®, AND SIMPLEX LITE® are registered trademarks of SAF-Holland, Inc., with which neither Pride Solutions LLC nor May Wes Manufacturing has an affiliation.



BULK POLY

UHMW POLYETHYLENE BY THE SQUARE FOOT - WHITE

PART NO	DESCRIPTION	THICKNESS	RETAIL PRICE
*80796	UHMW	1/8"	\$ 21 per sq ft
*80775	UHMW	1/4"	\$ 28 per sq ft
*80785	UHMW	3/8"	\$ 40 per sq ft
*80782	UHMW	1/2"	\$ 52 per sq ft
*80780	UHMW	3/4"	\$ 77 per sq ft
*80783	UHMW	1"	\$ 100 per sq ft

*\$100 Minimum.

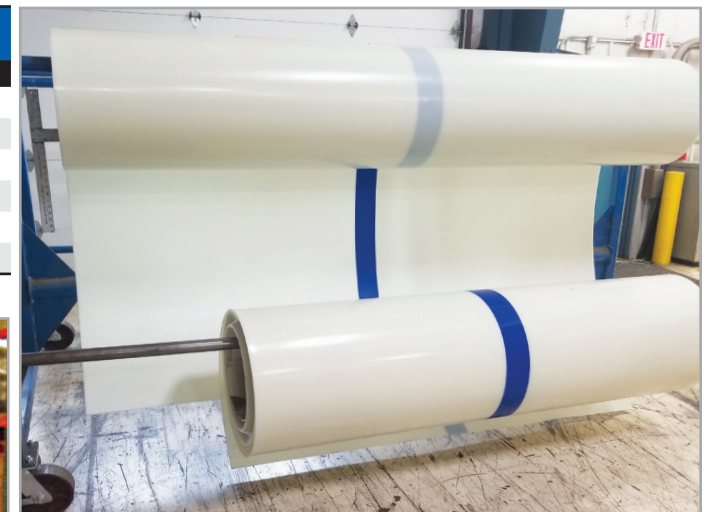

HIGH DENSITY POLYETHYLENE ON A ROLL - WHITE

1/8" - Under Elevated Farrowing Crates • U-Trough Feeders • Gutter Chute Liners

3/16" - Truck/Trailer Beds • Manure Spreaders

PART NO	DESCRIPTION	THICKNESS	RETAIL PRICE
*81785	8 foot (8' 3/4" wide, 96 3/4")	1/8"	\$ 35 per running foot
*81784	6 foot (6' 3 1/4" wide, 75 1/4")	3/16"	\$ 39 per running foot
*81783	8 foot (8' 3/4" wide, 96 3/4")	3/16"	\$ 49 per running foot
81775	6' 3 1/4" x 50'	3/16"	\$ 1475 ea
81778	8" wide x 50'	3/16"	\$ 2050 ea

UHMW POLYETHYLENE BY THE SHEET - WHITE

PART NO	DESCRIPTION	THICKNESS	RETAIL PRICE
81763	4' x 10' UHMW	1/8"	\$ 361 per sheet
81760	4' x 10' UHMW	1/4"	\$ 397 per sheet
81972	4' x 10' UHMW	3/8"	\$ 592 per sheet
81806	4' x 10' UHMW	1/2"	\$ 728 per sheet
80784	4' x 10' UHMW	3/4"	\$ 1115 per sheet
81973	4' x 10' UHMW	1"	\$ 1485 per sheet

Call for price/availability on other colors.

POLYURETHANE - BLACK

PART NO	DESCRIPTION	THICKNESS	RETAIL PRICE
80665	Polyurethane	1/4"	\$ 45 per sq ft

*\$200 Minimum. Due to large size, additional shipping fees may apply.

NON-STICK, DURABLE POLY PERFECT FOR TRUCK BED AND TRAILER LINERS

POLY CHAIN TIGHTENERS

POLY GIVES LONGER LIFE TO THE CHAIN AND OUTLASTS WOOD BLOCKS.

These are made of 100% UHMW Poly for added strength - lasting three to five times longer than other plastics. Replace wood with self-lubricating, long wearing poly tighteners.

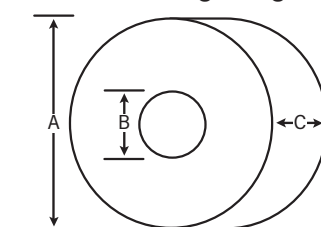
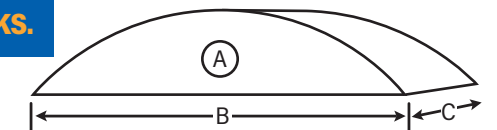

POLY CHAIN ROLLERS - WHITE

PART NO	A: OD	B: ID	C: THICKNESS	RETAIL PRICE
80744	1 5/8"	1/2"	1"	\$ 10 ea
80754	3"	1/2"	1 1/2"	\$ 14 ea
80756	4"	1 1/32"	1"	\$ 16 ea
80757	4"	1 1/32"	1 1/2"	\$ 20 ea

POLY HALF MOONS - WHITE

PART NO	A: HOLE DIAMETER	B: LENGTH	C: THICKNESS	RETAIL PRICE
80745	3/8"	3"	1 1/4"	\$ 14 ea
80746	3/8"	3"	2"	\$ 14 ea
80749	1/2"	3"	1 1/2"	\$ 14 ea
80755	3/8"	4"	1 1/4"	\$ 15 ea
80750	1/2"	4"	1 1/2"	\$ 15 ea
80753	5/8"	6"	5/8"	\$ 19 ea

Stronger and more durable than factory plastic.

POLY CAPPED BOLTS



POLY CAPPED BOLTS - PACKS OF 12			
PART NO	DESCRIPTION	THICKNESS	RETAIL PRICE
83638	Poly Capped Bolts - White	1/4" x 1"	\$ 31.00 pk
83639	Poly Capped Bolts - White	5/16" x 1"	\$ 49.00 pk
83640	Poly Capped Bolts - White	3/8" x 1"	\$ 42.00 pk
83733	Poly Capped Bolts - Black	1/2" x 1"	\$ 31.00 pk
83734	Poly Capped Bolts - Black	5/16" x 1"	\$ 49.00 pk
83735	Poly Capped Bolts - Black	3/8" x 1"	\$ 42.00 pk

CUSTOM ORDERS AVAILABLE



SCAN ME



- Ideal for high friction and high velocity applications
- Protect steel, aluminum, wood and other surfaces
- Use with poly surfaces to achieve 100% poly surface

Order online at maywes.com.

HARDWARE

BOLTS

FIFTH WHEEL COVER & MOLDBOARD BOLTS		
PART NO	DESCRIPTION	RETAIL PRICE
81300	2" Bolt	\$ 3.25 ea
80831	1 1/2" Bolt	\$ 3.25 ea

ELEVATOR BOLTS		
PART NO	DESCRIPTION	RETAIL PRICE
81293	Bag of 50 - 1/4" x 1"	\$ 18.25 ea

Fifth Wheel Cover & Moldboard Bolts

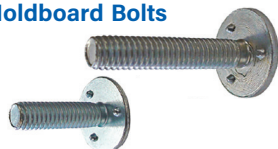

Elevator Bolts

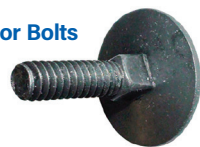

POUND RIVETS

10-16 SHORT POUND RIVETS (PREDRILLED SKIDS)

PART NO	DESCRIPTION	RETAIL PRICE
82197	Bag of 25 - 10-16 Short Rivets Length: .469" Head Diameter: .500" Grip Range: .266" - .359" Shaft Diameter: .250"	\$ 16.50 ea
81312	Bag of 135 - 10-16 Short Rivets	\$ 56.00 ea
81314	Bag of 170 - 10-16 Short Rivets	\$ 72.00 ea
81316	Bag of 220 - 10-16 Short Rivets	\$ 92.00 ea

12-16 MEDIUM POUND RIVETS (UNDRILLED SKIDS)

PART NO	DESCRIPTION	RETAIL PRICE
82198	Bag of 25 - 12-16 Medium Rivet Length: .531" Head Diameter: .500" Grip Range: .328" - .422" Shaft Diameter: .250"	\$ 18.50 ea
81313	Bag of 135 - 12-16 Medium Rivets	\$ 66.00 ea
81315	Bag of 170 - 12-16 Medium Rivets	\$ 80.00 ea
81317	Bag of 220 - 12-16 Medium Rivets	\$ 105.00 ea

16-16 LONG POUND RIVETS (EXTRA THICK METAL)

PART NO	DESCRIPTION	RETAIL PRICE
82199	Bag of 25 - 16-16 Long Rivet Length: .656" Head Diameter: .500" Grip Range: .453" - .547" Shaft Diameter: .250"	\$ 20.00 ea
82442	Bag of 50 - 16-16 Long Rivets	\$ 35.50 ea

POP RIVETS

SIZE 66 (SHORT POP RIVETS)

PART NO	DESCRIPTION	RETAIL PRICE
82189	Bag of 25 - Steel Small Head Length: .562" Shaft Diameter: .185" Head Diameter: .370"	\$ 14.00 ea
81306	Bag of 100 - Steel Small Head	\$ 35.50 ea
82190	Bag of 25 - Steel Large Head Length: .562" Shaft Diameter: .185" Head Diameter: .625"	\$ 13.50 ea
82107	Bag of 100 - Steel Large Head	\$ 36.00 ea

SIZE 68 (LONG POP RIVETS)

PART NO	DESCRIPTION	RETAIL PRICE
82191	Bag of 25 - Steel Small Head Length: .688" Shaft Diameter: .185" Head Diameter: .370"	\$ 14.00 ea
81302	Bag of 100 - Steel Small Head	\$ 35.50 ea
82192	Bag of 25 - Steel Large Head Length: .688" Shaft Diameter: .185" Head Diameter: .625"	\$ 14.00 ea
82106	Bag of 100 - Steel Large Head	\$ 36.00 ea

SIZE 86 (SHORT POP RIVETS)

PART NO	DESCRIPTION	RETAIL PRICE
82193	Bag of 25 - Steel Small Head Length: .620" Shaft Diameter: .250" Head Diameter: .50"	\$ 14.50 ea
82194	Bag of 100 - Steel Small Head	\$ 46.00 ea

SIZE 88 (LONG POP RIVETS)

PART NO	DESCRIPTION	RETAIL PRICE
82195	Bag of 25 - Steel Small Head Length: .75" Shaft Diameter: .250" Head Diameter: .50"	\$ 16.50 ea
82196	Bag of 100 - Steel Small Head	\$ 52.00 ea

POUND RIVET TOOL



PART NO	DESCRIPTION	RETAIL PRICE
81320	Pound Rivet Tool	\$ 40.00 ea

MEET OUR SISTER COMPANIES



May Wes Manufacturing
www.maywes.com
1-800-788-6483



Pride Engineered Plastics
Custom plastic parts manufacturer offering compression molding & CNC fabrication.
www.pridesolutions.com
1-320-587-0760

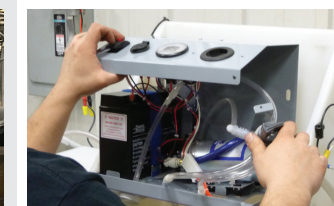

Pride Assembly
B2B Contract Assembly service offering mechanical & electromechanical assembly.
www.pridesolutions.com
1-320-587-0760



C&A Pro High Performance Snowmobile Skis
www.caproskis.com
1-888-321-6789

INTERESTED IN BECOMING A MAY WES DEALER?

Visit our website and click on "Dealers" in the top menu to fill out our Dealer Application, or scan the QR code.

www.maywes.com

SCAN ME



MEET OUR SALES TEAM



Eric Bates Sales Manager	Nancy Lauseng Marketing Manager	Ashley Adams Sales Associate	Matt Schmidt Technical Sales	Brianna Schmid Inside Sales	Allison Christensen Graphic Design & Social Media Specialist	Ryan Greenwaldt Brand Manager, C&A Pro Skis
------------------------------------	---	--	--	---------------------------------------	--	---

WE LOOK FORWARD TO WORKING WITH YOU!

1-800-788-6483

sales@maywes.com

PRSRT STD
US POSTAGE
PAID
KENT, OH
PERMIT #15

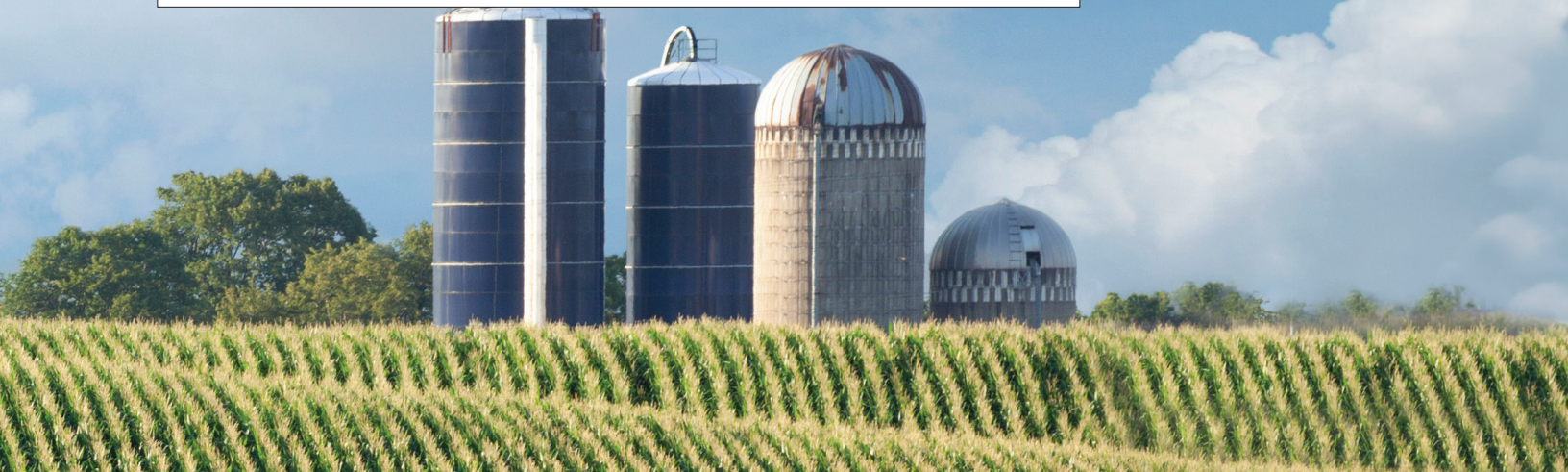

Order Online 24/7

www.maywes.com

1 (800) 788-6483

120 Eastgate Drive SE | Hutchinson, MN 55350

COME VISIT US AT THESE SHOWS IN 2024 - 2025

Farmfest	August 6 - 8, 2024	Morgan, MN
Farm Progress	August 27 - 29, 2024	Boone, IA
Husker Harvest	September 10 - 12, 2024	Grand Island, NE
Farm Science Review	September 17 - 19, 2024	London, OH
National Farm Machinery Show	February 12 - 15, 2025	Louisville, KY
Commodity Classic	March 2 - 4, 2025	Denver, CO



Show dates are subject to change or cancellation. Visit www.maywes.com/events for updates and more information.